

# BX Series Long Sensing, Amplifier Built-in Type With Universal Voltage (terminal)

## Terminal Type and Long Sensing Distance Type

### ■ Features

- Sensitivity adjuster
- Timer function: ON Delay, OFF Delay, One-shot Delay
- NPN/PNP open collector output (DC power type)
- Self-diagnosis function (green LED turns on in stable level)
- Wide power supply range: Universal 24-240VDC/24-240VAC
- Protection structure IP66 (IEC standard)

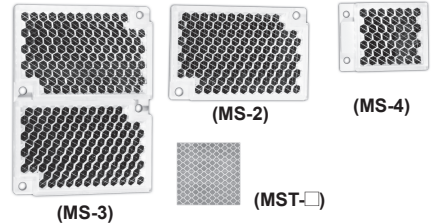

※MS-4, MST-□ is sold separately.

**⚠ Please read "Safety Considerations" in operation manual before using.**



### ■ Specifications

#### ◎ Free power type, Relay contact output type

Model	Standard type	BX15M-TFR	BX5M-MFR	BX3M-PFR	BX700-DFR
	With Timer	BX15M-TFR-T	BX5M-MFR-T	BX3M-PFR-T	BX700-DFR-T
Sensing type		Through-beam	Retroreflective (standard type)	Retroreflective (built-in polarizing filter)	Diffuse reflective
Sensing distance		15m	5m <sup>※1</sup>	3m <sup>※2</sup>	700mm <sup>※3</sup>
Sensing target		Opaque materials of Min. Ø15mm	Opaque materials of Min. Ø60mm		Translucent, opaque material
Hysteresis		—			Max. 20% at rated setting distance
Response time		Max. 20ms			
Power supply		24-240VAC~±10% 50/60Hz, 24-240VDC=±10% (ripple P-P: max. 10%)			
Power consumption		Max. 3VA			
Light source		Infrared LED (850nm)		Red LED (660nm)	Infrared LED (940nm)
Sensitivity adjustment		Sensitivity adjuster			
Operation mode		Light ON/Dark ON operation mode switch			
Control output		Relay contact output (contact capacity: 30VDC= 3A, 250VAC~ 3A at resistive load, contact composition: 1c) <sup>※4</sup>			
Relay life cycle		Mechanically: min. 50,000,000, electrically: min. 100,000			
Self-diagnosis output		Self-diagnosis indicator (green LED) turns on at stable operation			
Timer function		Selectable ON delay, OFF delay, one shot delay by slide switch [delay time: 0.1 to 5sec (timer adjuster)]			
Indicator		Operation indicator: yellow LED, self-diagnosis indicator: green LED			
Connection		Terminal connection			
Insulation resistance		Over 20MΩ (at 500VDC megger)			
Insulation type		Double or strong insulation (mark:  , dielectric voltage between the measured input and the power: 1.5kV)			
Noise immunity		±1,000V the square wave noise (pulse width: 1μs) by the noise simulator			
Dielectric strength		1500VAC 50/60Hz for 1minute			
Vibration	Mechanical	1.5mm amplitude at frequency of 10 to 55Hz (for 1 min) in each X, Y, Z direction for 2 hours			
	Malfunction	1.5mm amplitude at frequency of 10 to 55Hz (for 1 min) in each X, Y, Z direction for 10 minutes			
Shock	Mechanical	500m/s <sup>2</sup> (approx. 50G) in each X, Y, Z direction for 3 times			
	Malfunction	100m/s <sup>2</sup> (approx. 10G) in each X, Y, Z direction for 3 times			
Environment	Ambient illumination	Sunlight: max. 11,000lx, incandescent lamp: max. 3,000lx (receiver illumination)			
	Ambient temperature	-20 to 55°C, storage: -25 to 70°C			
	Ambient humidity	35 to 85%RH, storage: 35 to 85%RH			
Protection structure		IP66 (IEC standard)			
Material		Case, lens cover: polycarbonate, sensing part: acrylic, bracket: steel plate cold commercial, bolt: steel chromium molybdenum, nut: steel chromium molybdenum			
Accessory	Individual	—	Reflector (MS-2)	Reflector (MS-3)	—
	Common	Adjuster driver, fixing bracket, bolts, nuts			
Approval		<b>CE</b>			
Unit weight		TFR: approx. 225g	MFR: approx. 130g	PFR: approx. 148g	DFR: approx. 115g
		TFR-T: approx. 226g	MFR-T: approx. 131g	PFR-T: approx. 149g	DFR-T: approx. 116g

※1: The sensing distance is specified with using the MS-2 reflector. It is the same when using the MS-4 reflector (sold separately).  
The sensor can detect under 0.1m.

※2: The sensing distance is specified with using the MS-3 reflector. When using the MS-2 reflector, the sensing distance is 0.1 to 2m.  
The sensor can detect under 0.1m. When using reflective tapes, the reflectivity will vary by the size of the tape. Please refer to the "Reflectivity By Reflective Tape Model" table before using the tapes.

※3: Non-glossy white paper 200×200mm.

※4: Relay contact output of 1a type is option.

※The temperature or humidity mentioned in Environment indicates a non freezing or condensation environment.

(A)	Photoelectric Sensors
(B)	Fiber Optic Sensors
(C)	Door/Area Sensors
(D)	Proximity Sensors
(E)	Pressure Sensors
(F)	Rotary Encoders
(G)	Connectors/ Connector Cables/ Sensor Distribution Boxes/ Sockets
(H)	Temperature Controllers
(I)	SSRs / Power Controllers
(J)	Counters
(K)	Timers
(L)	Panel Meters
(M)	Tacho / Speed / Pulse Meters
(N)	Display Units
(O)	Sensor Controllers
(P)	Switching Mode Power Supplies
(Q)	Stepper Motors & Drivers & Controllers
(R)	Graphic/ Logic Panels
(S)	Field Network Devices
(T)	Software

# BX Series

## ■ Specifications

### ◎ DC power type, Solid state output type

Model	Standard type	<b>BX15M-TDT</b>	<b>BX5M-MDT</b>	<b>BX3M-PDT</b>	<b>BX700-DDT</b>
	With Timer	<b>BX15M-TDT-T</b>	<b>BX5M-MDT-T</b>	<b>BX3M-PDT-T</b>	<b>BX700-DDT-T</b>
Sensing type	Through-beam		Retroreflective (standard type)	Retroreflective (built-in polarizing filter)	Diffuse reflective
Sensing distance	15m		5m <sup>*1</sup>	3m <sup>*2</sup>	700mm <sup>*3</sup>
Sensing target	Opaque materials of Min. Ø15mm		Opaque materials of Min. Ø60mm		Translucent, opaque material
Hysteresis	—				Max. 20% at rated setting distance
Response time	Max. 1ms				
Power supply	12-24VDC $\pm$ 10% (ripple P-P: max. 10%)				
Current consumption	Max. 50mA				
Light source	Infrared LED (850nm)			Red LED (660nm)	Infrared LED (940nm)
Sensitivity adjustment	Sensitivity adjuster				
Operation mode	Light ON/Dark ON operation mode switch				
Control output	NPN or PNP open collector output ●Load voltage: max. 30VDC $\pm$ ●Load current: max. 200mA ●Residual voltage - NPN: max. 1VDC $\pm$ , PNP: max. 2.5VDC				
Self-diagnosis output	NPN open collector output (green LED turns on at stable operation and output (transistor output) turns on) ●Load voltage: max. 30VDC $\pm$ ●Load current: max. 50mA ●Residual voltage - max. 1VDC $\pm$ (50mA), max. 0.4VDC(16mA)				
Protection circuit	Reverse polarity protection circuit, output overcurrent (short-circuit) protection circuit				
Timer function	Selectable ON delay, OFF delay, one shot delay by slide switch [delay time: 0.1 to 5sec (timer adjuster)]				
Indicator	Operation indicator: Yellow LED, Self-diagnosis indicator: Green LED				
Connection	Terminal connection				
Insulation resistance	Over 20MΩ (at 500VDC megger)				
Noise immunity	$\pm$ 240V the square wave noise (pulse width: 1μs) by the noise simulator				
Dielectric strength	1500VAC 50/60Hz for 1minute				
Vibration	Mechanical	1.5mm amplitude at frequency of 10 to 55Hz (for 1 min) in each X, Y, Z direction for 2 hours			
	Malfunction	1.5mm amplitude at frequency of 10 to 55Hz (for 1 min) in each X, Y, Z direction for 10 minutes			
Shock	Mechanical	500m/s <sup>2</sup> (approx. 50G) in each X, Y, Z direction for 3 times			
	Malfunction	100m/s <sup>2</sup> (approx. 10G) in each X, Y, Z direction for 3 times			
Environment	Ambient illumination	Sunlight: Max. 11,000lx, Incandescent lamp: Max. 3,000lx (receiver illumination)			
	Ambient temperature	-20 to 55°C, storage: -25 to 70°C			
	Ambient humidity	35 to 85%RH, storage: 35 to 85%RH			
Protection structure	IP66 (IEC standard)				
Material	Case, Lens cover: polycarbonate, sensing part: acrylic, bracket: steel plate cold commercial, bolt: steel chromium molybdenum, nut: steel chromium molybdenum				
Accessory	Individual	—	Reflector (MS-2)	Reflector (MS-3)	—
	Common	Adjuster driver, fixing bracket, bolts, nuts			
Approval	<b>CE</b>				
Unit weight	TDT: approx. 211g	MDT: approx. 123g	PDT: approx. 141g	DDT: approx. 116g	
	TDT-T: approx. 212g	MDT-T: approx. 124g	PDT-T: approx. 142g	DDT-T: approx. 117g	

※1: The sensing distance is specified with using the MS-2 reflector. It is the same when using the MS-4 reflector (sold separately).  
The sensor can detect under 0.1m.

※2: The sensing distance is specified with using the MS-3 reflector. When using the MS-2 reflector, the sensing distance is 0.1 to 2m.  
The sensor can detect under 0.1m.

When using reflective tapes, the reflectivity will vary by the size of the tape. Please refer to the "■ Reflectivity By Reflective Tape Model" table before using the tapes.

※3: Non-glossy white paper 200×200mm.

※The temperature or humidity mentioned in Environment indicates a non freezing or condensation environment.

# Long Sensing, Amplifier Built-in Type With Universal Voltage (terminal)

## ■ Feature Data

### ⊙ Through-beam type

- BX15M-TFR / BX15M-TFR-T
- BX15M-TDT / BX15M-TDT-T

### ⊙ Diffuse reflective type

- BX700-DFR / BX700-DFR-T
- BX700-DDT / BX700-DDT-T

Parallel shifting characteristic		Angle Characteristic		Sensing area	
Measuring method	Data	Measuring method	Data	Measuring method	Data

### ⊙ Retroreflective type

- BX5M-MFR / BX5M-MFR-T
- BX5M-MDT / BX5M-MDT-T

Parallel shifting characteristic		Angle Characteristic		Reflector angle characteristic	
Measuring method	Data	Measuring method	Data	Measuring method	Data

### ⊙ Retroreflective type (Built-in polarizing filter)

- BX3M-PFR / BX3M-PFR-T
- BX3M-PDT / BX3M-PDT-T

Parallel shifting characteristic		Sensor angle characteristic		Reflector angle characteristic	
Measuring method	Data	Measuring method	Data	Measuring method	Data

(A) Photoelectric Sensors

(B) Fiber Optic Sensors

(C) Door/Area Sensors

(D) Proximity Sensors

(E) Pressure Sensors

(F) Rotary Encoders

(G) Connectors/ Connector Cables/ Sensor Distribution Boxes/ Sockets

(H) Temperature Controllers

(I) SSRs / Power Controllers

(J) Counters

(K) Timers

(L) Panel Meters

(M) Tacho / Speed / Pulse Meters

(N) Display Units

(O) Sensor Controllers

(P) Switching Mode Power Supplies

(Q) Stepper Motors & Drivers & Controllers

(R) Graphic/ Logic Panels

(S) Field Network Devices

(T) Software

# BX Series

## ■ Control Output Diagram

### ◎ Free power type (Relay contact output)

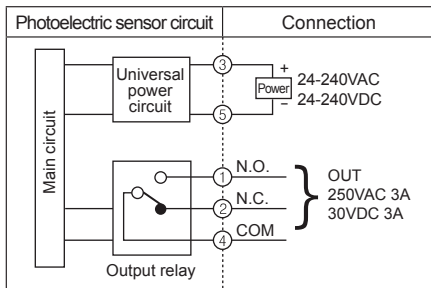

### ◎ DC power type (NPN/PNP open collector simultaneous output)

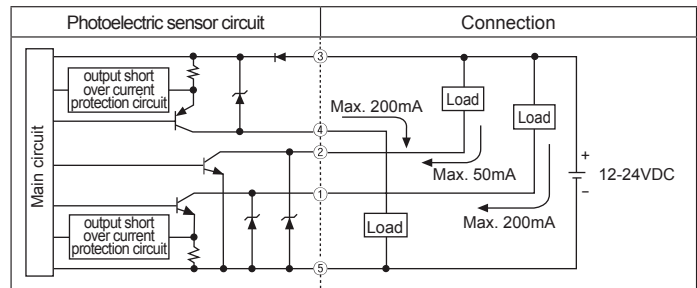

※ In case of product with the output protection device, if terminals of control output are short-circuited or overcurrent condition exists, the control output will turn off due to protection circuit.

## ■ Operation Timing Diagram

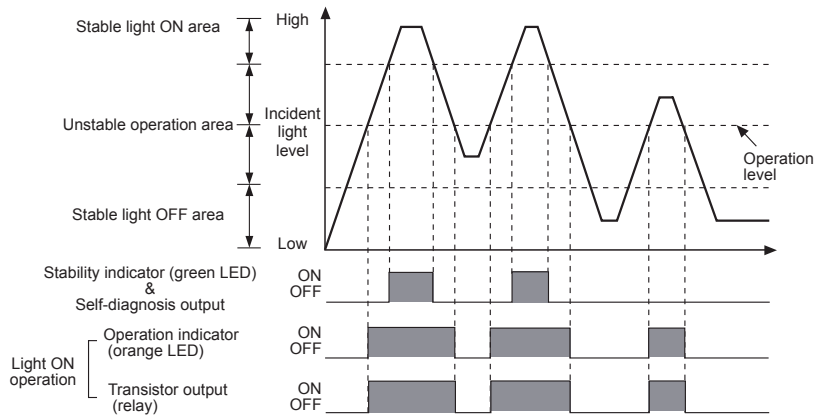

※ The waveforms of "Operation indicator" and "Transistor output" are for Light ON operation. They are opposite operation for Dark ON operation.  
 ※ If the control output terminal is short-circuit or over current than the rated current flows in the unit, the sensor does not operate normally by protection circuit.

## ■ Timer Mode

Timer mode	Switch position		Status of light	Received light	Interrupted light
	S1	S2			
Normal	ON	ON	Light ON	ON	
			Dark ON	OFF	
One-shot Delay	ON	OFF	Light ON	ON	
			Dark ON	OFF	
ON Delay	OFF	ON	Light ON	ON	
			Dark ON	OFF	
OFF Delay	OFF	OFF	Light ON	ON	
			Dark ON	OFF	

※ T: Time can be set by the timer adjuster.  
 ※ Conversion to other timer modes is applied after a former mode is finished.

# Long Sensing, Amplifier Built-in Type With Universal Voltage (terminal)

## ■ Connections

### ◎ Through-beam type

#### ● BX15M-TFR1

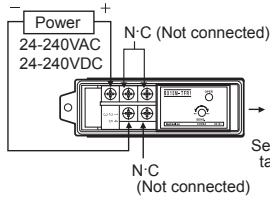

#### ● BX15M-TFR2 BX15M-TFR2-T

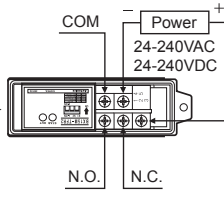

#### ● BX15M-TDT1

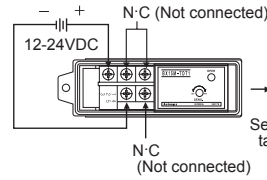

#### ● BX15M-TDT2 BX15M-TDT2-T

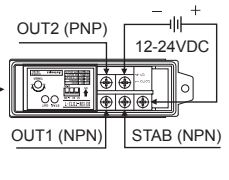

### ◎ Retroreflective type / Retroreflective type with polarizing filter

#### ● BX5M-MFR, BX5M-MFR-T (standard type)

#### ● BX3M-PFR, BX3M-PFR-T (built-in polarizing filter)

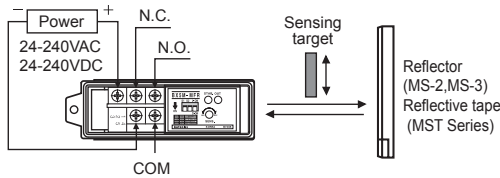

#### ● BX5M-MDT, BX5M-MDT-T (standard type)

#### ● BX3M-PDT, BX3M-PDT-T (built-in polarizing filter)

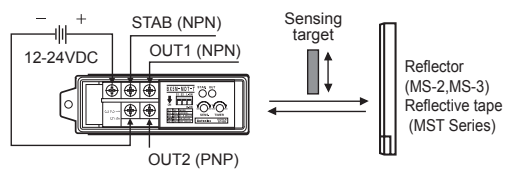

### ◎ Diffuse reflective type

#### ● BX700-DFR, BX700-DFR-T

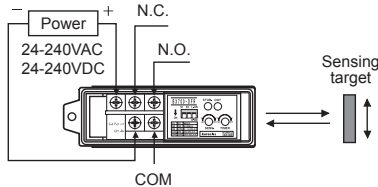

#### ● BX700-DDT, BX700-DDT-T

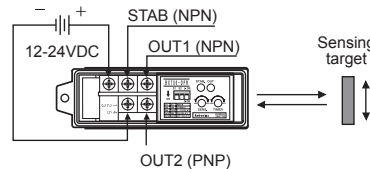

### ◎ Cable

(unit: mm)

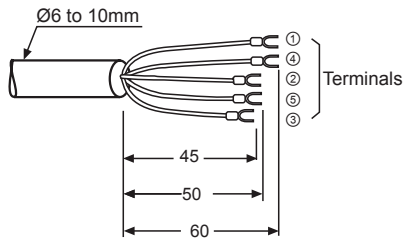

#### ● Terminal size

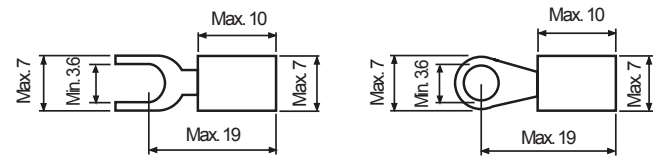

Wire holder

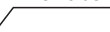

Washer

Waterproof rubber



Cover

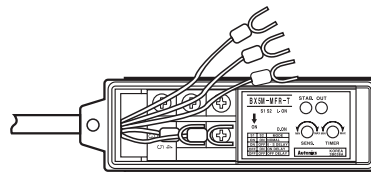

※ To connect the wires on the terminal, following as above figures.

※ Select the round wire with the size of Ø6 to 10mm for the waterproof and tighten the cable holder by torque of 1.0 to 1.5N·m.

※ To connect the wires on the terminal, tighten screws by torque of 0.8N·m.

(A) Photoelectric Sensors

(B) Fiber Optic Sensors

(C) Door/Area Sensors

(D) Proximity Sensors

(E) Pressure Sensors

(F) Rotary Encoders

(G) Connectors/ Connector Cables/ Sensor Distribution Boxes/ Sockets

(H) Temperature Controllers

(I) SSRs / Power Controllers

(J) Counters

(K) Timers

(L) Panel Meters

(M) Tacho / Speed / Pulse Meters

(N) Display Units

(O) Sensor Controllers

(P) Switching Mode Power Supplies

(Q) Stepper Motors & Drivers & Controllers

(R) Graphic/ Logic Panels

(S) Field Network Devices

(T) Software

# BX Series

## ■ Front Panel Identification

### ◎ Through-beam type

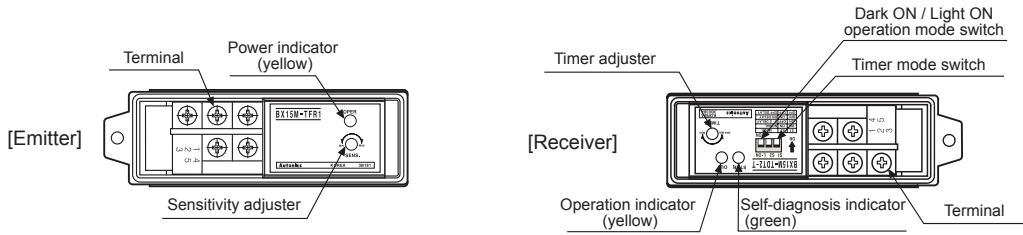

### ◎ Retroreflective type (Standard type, Built-in polarizing filter)

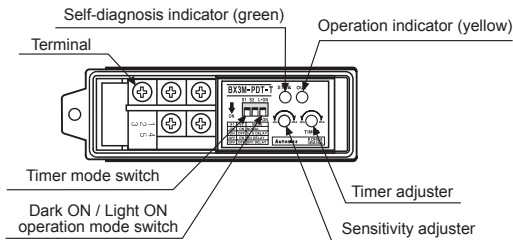

### ◎ Diffuse reflective type

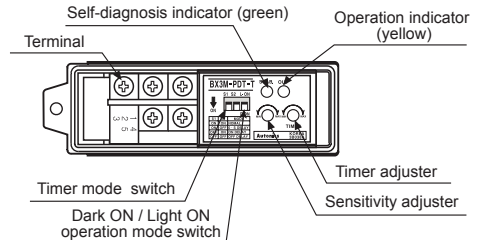

※There are no timer mode switch and the timer adjuster in no timer function type.

## ■ Dimensions

(unit: mm)

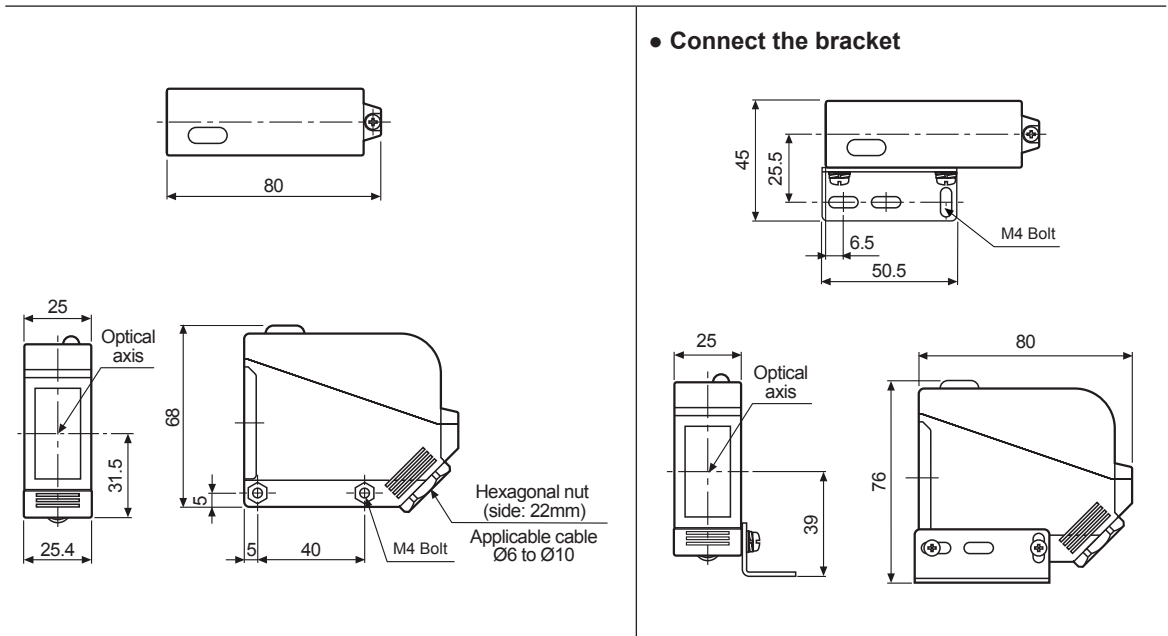

# Long Sensing, Amplifier Built-in Type With Universal Voltage (terminal)

## ■ Dimensions

### ● Bracket

(unit: mm)

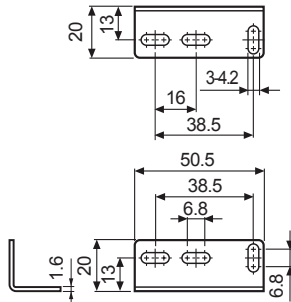

### ● Reflector

• MS-2

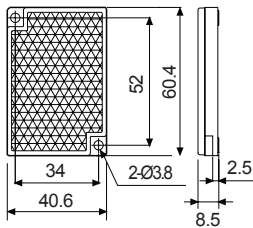

• MS-3 (sold separately)

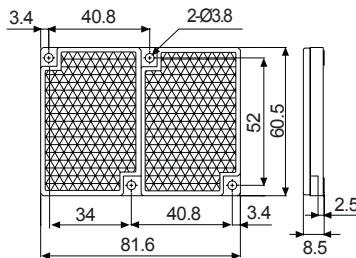

• MS-4 (sold separately)

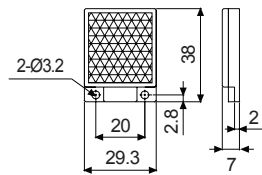

### ● Reflective tape (sold separately)

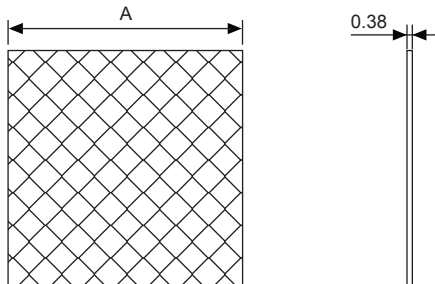

(unit: mm)

Model	A
MST-50-10	□50
MST-100-5	□100
MST-200-2	□200

## ■ Mounting and Sensitivity Adjustment

### ◎ Through-beam type

1. Supply the power to the photoelectric sensor, after setting the emitter and the receiver facing each other.
2. Set the receiver in center of position in the middle of the operation range of indicator by adjusting the receiver or the emitter right and left, up and down.
3. After the adjustment, check the stability of operation by putting the object at the optical axis.

※If the sensing target is translucent body or smaller than  $\varnothing 15\text{mm}$ , it can be missed by sensor because light penetrate it.

※Sensitivity adjustment: Refer to the diffuse reflective type's.

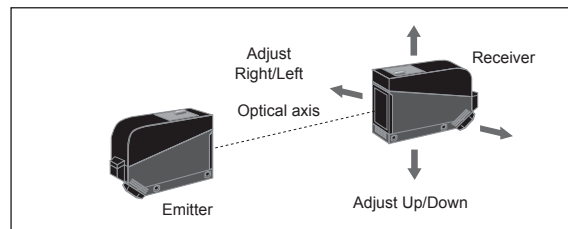

(A) Photoelectric Sensors

(B) Fiber Optic Sensors

(C) Door/Area Sensors

(D) Proximity Sensors

(E) Pressure Sensors

(F) Rotary Encoders

(G) Connectors/ Connector Cables/ Sensor Distribution Boxes/ Sockets

(H) Temperature Controllers

(I) SSRs / Power Controllers

(J) Counters

(K) Timers

(L) Panel Meters

(M) Tacho / Speed / Pulse Meters

(N) Display Units

(O) Sensor Controllers

(P) Switching Mode Power Supplies

(Q) Stepper Motors & Drivers & Controllers

(R) Graphic/ Logic Panels

(S) Field Network Devices

(T) Software

# BX Series

## ◎ Diffuse reflective type

1. The sensitivity should be adjusted depending on a sensing target or mounting place.
  2. Set the sensing target at a position to be sensed by the beam, then turn the sensitivity adjuster from the min. position of the sensitivity adjuster to the position ㉑ where the operation indicator (yellow LED) turns ON. (The self-diagnosis indicator (green LED) is in OFF status.)
  3. The operation indicator turns OFF, when the sensing target is removed from the position ㉑. Without the sensing target, turn the sensitivity adjuster from the position ㉑ to position ㉒ where the operation indicator (yellow LED) turns ON. (If the operation indicator does not turn ON, max. position of the sensitivity adjuster is ㉒.)
  4. Set the sensitivity adjuster at the center of two switching position ㉑, ㉒.
- ※Above sensitivity adjustment is for Light ON mode. If it is for Dark ON mode, operation indicator (yellow LED) operates opposite.
- ※The sensing distance indicated on specification chart is for 200×200mm of non-glossy white paper. Be sure that it can be different by size, surface and gloss of target.

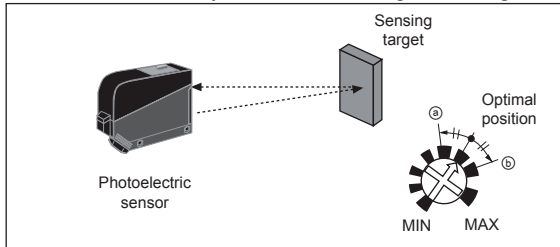

## ◎ Retroreflective type

1. Supply the power to the photoelectric sensor, after setting the photoelectric sensor and the reflector or reflective tape face to face.
  2. Set the photoelectric sensor in the position which indicator turns on, by adjusting the reflector (or reflective tape) or the sensor right and left, up and down.
  3. Fix both units tightly after checking that the unit detects the target.
- ※If using more than 2 photoelectric sensors in parallel, the space among them should be more than 30cm.
- ※If reflectance of target is higher than non-glossy white paper, it might cause malfunction by reflection from the target when the target is near to photoelectric sensor. Therefore put enough space between the target and the photoelectric sensor or the surface of the target should be installed at angle of 30° to 45° against optical axis. (When a sensing target with high reflectance near by, photoelectric sensing with the polarizing filter should be used.)
- ※Sensitivity adjustment: Refer to the diffuse reflective type's.

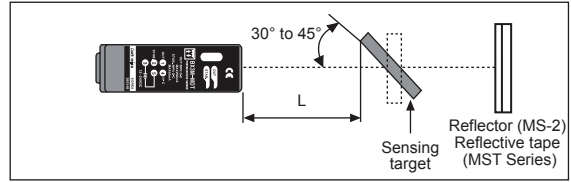
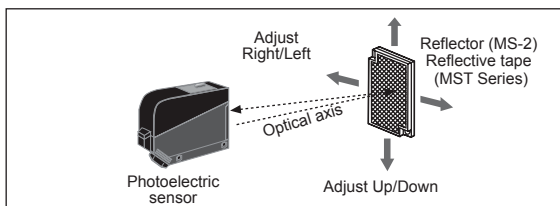

※If the mounting place is too narrow, please use MS-4 instead of MS-2.

※Please use reflective tape (MST Series) for where a reflector is not installed.

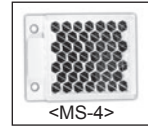

## ◎ Retroreflective type (Built-in polarizing filter)

The light passed through the polarizing filter of the emitter reaches to the MS-3 reflector or reflective tape converting as horizontal direction. It reaches to the receiver element of polarizing filter converting as vertical by the MS-3 reflector or reflective tape. Therefore, this type can also detect reflective mirror.

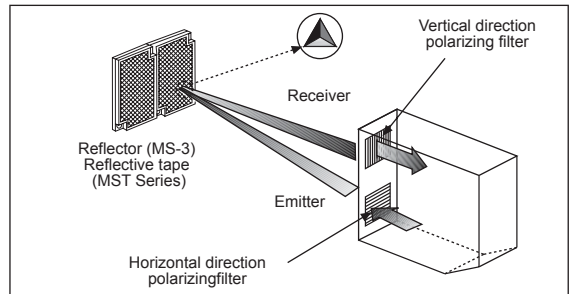

※Please use reflective tape (MST Series) for where a reflector is not installed.

## ■ Reflectivity by Reflective Tape Model

Model	Standard	Built-in polarizing filter
MST-50-10 (50×50mm)	90%	30%
MST-100-5 (100×100mm)	100%	40%
MST-200-2 (200×200mm)	110%	60%

※This reflectivity is based on the reflector (MS-2).

※Reflectivity may vary depending on usage environment and installation conditions.

The sensing distance and minimum sensing target size increase as the size of the tape increases.

Please check the reflectivity before using reflective tapes.

※For using reflective tape, installation distance should be min. 20mm.