

DIN W48×H48mm Compact Counter/Timer

Upgrade

■ Features

- Counting speed: 1cps/30cps/2kcps/5kcps
- Selectable voltage input (PNP) or no-voltage input (NPN)
- Input mode: Up, Down, Up/Down
- Dot for Decimal Point / Hour. Min. Second by RESET key
- Wide range of input power supply
: 100-240VAC 50/60Hz, 24VAC 50/60Hz, 24-48VDC universal
- Selectable Counter/Timer by internal DIP switch
- [Counter]
20 input modes/18 output modes
- [Timer]
16 output modes
Various time setting range - 5-digit model: 0.01 sec to 9999.9 hour /
4-digit model: 0.01 sec to 9999 hour
- Output: Indicator, 1-stage setting

Shaded parts(■) are changed and added functions from previous FXS Series.



⚠ Please read "Safety considerations" in operation manual before using.



■ Model

Model	Display digit	Size	Output	Power supply
FX4S-1P2	9999 (4-digit)	DIN W48×H48mm	1-stage setting	24VAC 50/60Hz, 24-48VDC
FX4S-1P4				100-240VAC 50/60Hz
FX5S-I2	99999 (5-digit)		Indicator	24VAC 50/60Hz, 24-48VDC
FX5S-I4				100-240VAC 50/60Hz

■ Specifications

Model	1-stage setting	FX4S-1P2	FX4S-1P4	FX5S-I2	FX5S-I4
	Indicator	—	—	—	—
Display digit		4-digit		5-digit	
Character size (W×H)		3.8×7.6mm		4×8mm	
Power supply		24VAC~ 50/60Hz, 24-48VDC	100-240VAC~ 50/60Hz	24VAC~ 50/60Hz, 24-48VDC	100-240VAC~ 50/60Hz
Permissible voltage range		90 to 110% of rated voltage			
Power consumption		AC: Max. 3.5VA DC: Max. 2.3W	Max. 4.6VA	AC: Max. 3VA DC: Max. 1.8W	Max. 3.8VA
Max. counting speed of CP1/CP2		Selectable 1cps/30cps/2kcps/5kcps (DIP switch)			
Return time		Max. 500ms			
Min. signal width		INHIBIT, RESET input: approx. 20ms			
Input method		Selectable voltage input (PNP) method or no-voltage input (NPN) method [Voltage input (PNP) method]-input impedance: max. 10.8kΩ, [H]: 5-30VDC, [L]: 0-2VDC [No-voltage input (NPN) method]-short-circuit impedance: max. 470Ω, short-circuit residual voltage: max. 1VDC, open-circuit impedance: min. 100kΩ			
One-shot output time		0.05 to 5 sec			
Control output	Contact	Type	Instantaneous SPDT (1c)		
		Capacity	250VAC~ 3A resistive load		
	Solid state	Type	NPN open collector: 1		
		Capacity	Max. 30VDC, 100mA		
Relay life cycle	Mechanical	Min. 5,000,000 operations			
	Electrical	Min. 100,000 operations (250VAC 3A resistive load)			
Repeat/Set/Voltage/Temperature error		Max. ±0.01% ±0.05 sec			
Insulation resistance		Over 100MΩ (at 500VDC megger)			
External power supply		Max. 12VDC ±10% 50mA			
Memory retention		Approx. 10 years (non-volatile memory)			
Dielectric strength		2,000VAC 50/60Hz for 1 minute (between all terminals and case)			
Noise immunity	AC voltage	±2kV the square wave noise (pulse width 1μs) by the noise simulator			
	AC/DC voltage	±500V the square wave noise (pulse width 1μs) by the noise simulator			
Vibration	Mechanical	0.75mm amplitude at frequency 10 to 55Hz (for 1 min) in each X, Y, Z direction for 1hour			
	Malfunction	0.5mm amplitude at frequency 10 to 55Hz (for 1 min) in each X, Y, Z direction for 10min			
Shock	Mechanical	300m/s ² (approx. 30G) in each X, Y, Z direction for 3 times			
	Malfunction	100m/s ² (approx. 10G) in each X, Y, Z direction for 3 times			
Environment	Ambient temperature	-10 to 55°C, storage: -25 to 65°C			
	Ambient humidity	35 to 85%RH, storage: 35 to 85%RH			
Protection structure		IP20 (front part, IEC standard)			
Approval		CE, c, UL US			
Weight ^{※1}		Approx. 171g (approx. 110g)		Approx. 156g (approx. 95g)	

※1: The weight includes packaging. The weight in parenthesis is for unit only. ※Environment resistance is rated at no freezing or condensation.

Up/Down Counter/Timer

Connections

● FX4S-1P□

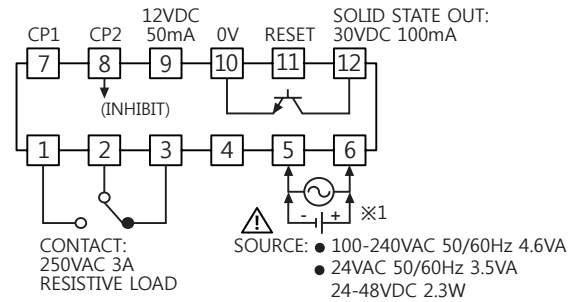

※1: AC voltage: 100-240VAC 50/60Hz 4.6VA/3.8VA

AC/DC voltage: 24VAC 50/60Hz 3.5VA/3VA, 24-48VDC 2.3W/1.8W

※INHIBIT: In case of timer mode, this terminal is for time hold.

(voltage input (PNP): connect with 12VDC, no-voltage input (NPN): connect with 0VDC)

● FX5S-□

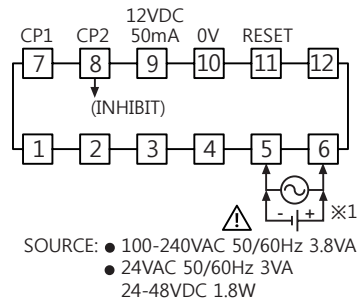

Dimensions

(unit: mm)

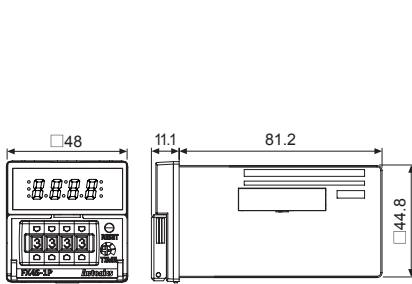

● Bracket

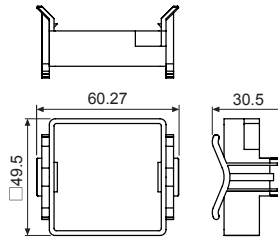

● Panel cut-out

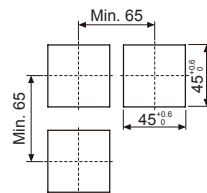

Input Connection

◎ Voltage input (PNP)

● Solid state input (standard sensor: PNP output type sensor)

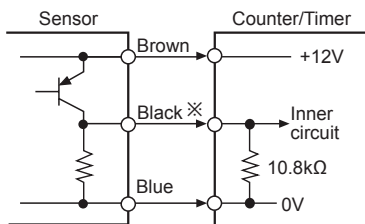

(PNP output)

※CP1, CP2 (INHIBIT), RESET input part

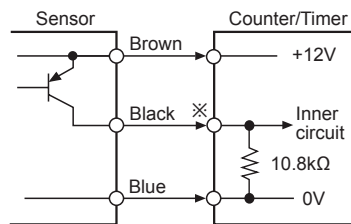

(PNP open collector output)

● Contact input

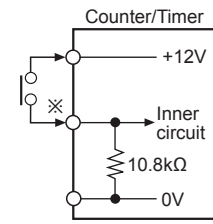

※Counting speed: Set as 1 or 30cps

◎ No-voltage input (NPN)

● Solid state input (standard sensor: NPN output type sensor)

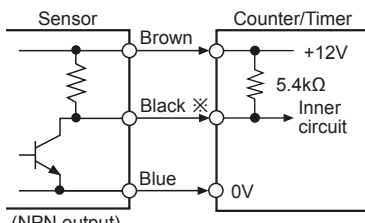

(NPN output)

※CP1, CP2 (INHIBIT), RESET input part

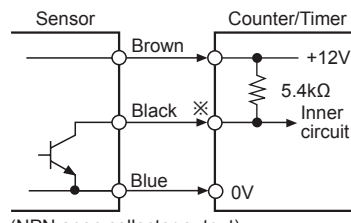

(NPN open collector output)

● Contact input

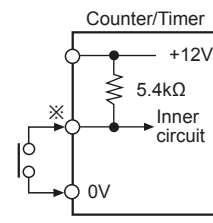

※Counting speed: Set as 1 or 30cps

- (A) Photoelectric Sensors
- (B) Fiber Optic Sensors
- (C) Door/Area Sensors
- (D) Proximity Sensors
- (E) Pressure Sensors
- (F) Rotary Encoders
- (G) Connectors/ Connector Cables/ Sensor Distribution Boxes/Sockets
- (H) Temperature Controllers
- (I) SSRs / Power Controllers
- (J) Counters
- (K) Timers
- (L) Panel Meters
- (M) Tacho / Speed / Pulse Meters
- (N) Display Units
- (O) Sensor Controllers
- (P) Switching Mode Power Supplies
- (Q) Stepper Motors & Drivers & Controllers
- (R) Graphic/ Logic Panels
- (S) Field Network Devices
- (T) Software

FXS Series

DIP Switch Setting

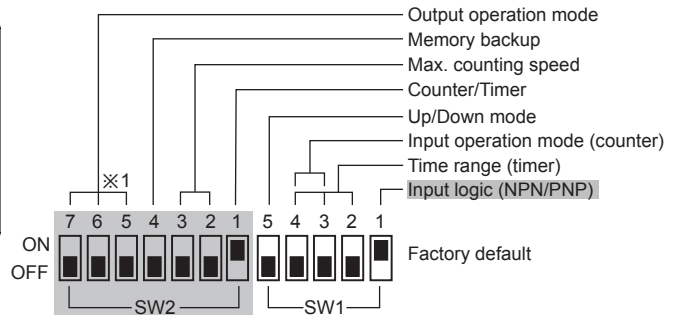
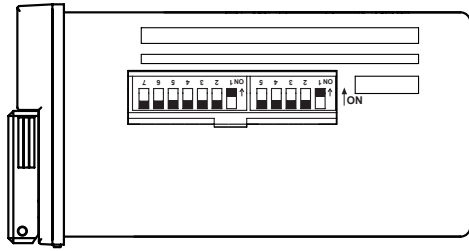

※1: Indicator model (FXS5-I□) does not have no. 5, 6, 7 of SW2. for output operation mode setting.

● Input logic

(CP1, CP2, INHIBIT, RESET input)

SW1	Function
1 ON OFF <input type="checkbox"/>	NPN (No-voltage input)
ON OFF <input type="checkbox"/>	PNP (voltage input)

● Up/Down mode

SW1	Function
5 ON OFF <input type="checkbox"/>	Down mode
ON OFF <input type="checkbox"/>	Up mode

● Counter/Timer

SW2	Function
1 ON OFF <input type="checkbox"/>	Counter mode
ON OFF <input type="checkbox"/>	Timer mode

● Memory backup

SW2	Function
4 ON OFF <input type="checkbox"/>	No memory backup
ON OFF <input type="checkbox"/>	Memory backup

● Max. counting speed

SW2	3 2	3 2	3 2	3 2
ON OFF <input type="checkbox"/>	ON OFF <input type="checkbox"/>	ON OFF <input type="checkbox"/>	ON OFF <input type="checkbox"/>	ON OFF <input type="checkbox"/>
Function	1cps	30cps	2kcps	5kcps

● Time range (timer)

SW1	FX4S-1P□	FX5S-I□
4 3 2 ON OFF <input type="checkbox"/>	99.99sec	9999.9sec
4 3 2 ON OFF <input type="checkbox"/>	999.9sec	99999sec
4 3 2 ON OFF <input type="checkbox"/>	9999sec	9min 59.99sec
4 3 2 ON OFF <input type="checkbox"/>	99min 59sec	99min 59.9sec
4 3 2 ON OFF <input type="checkbox"/>	999.9min	9999.9min
4 3 2 ON OFF <input type="checkbox"/>	99hour 59min	9hour 59min 59sec
4 3 2 ON OFF <input type="checkbox"/>	999.9hour	999hour 59min
4 3 2 ON OFF <input type="checkbox"/>	9999hour	9999.9hour

Up/Down Counter/Timer

Dot For Decimal Point / Hour. Min. Second

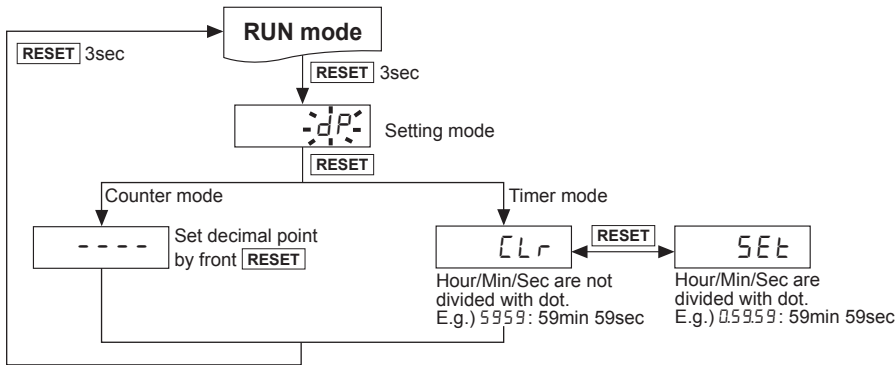

- ※Run mode: hold the **RESET** key for over 3 sec, and it enters setting mode [dP].
- ※Setting mode: hold the **RESET** key for over 3 sec, and it saves the setting and returns to RUN mode.
If there is no **RESET** key input for 60 sec when entering setting mode, it returns to RUN mode.

Changing the decimal point

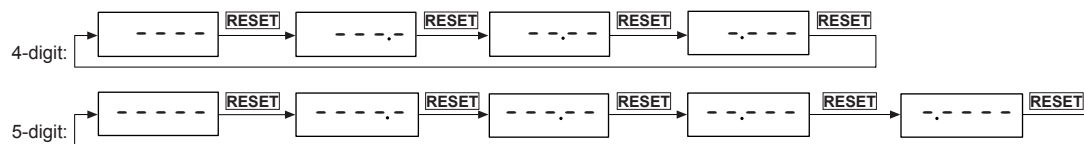

※It returns to RUN mode if no **RESET** key or digital switch is applied for 60 sec in decimal point setting status.

Counting & Time Operation For Indicator (FX5S-I□)

Counting operation

Input mode: Up

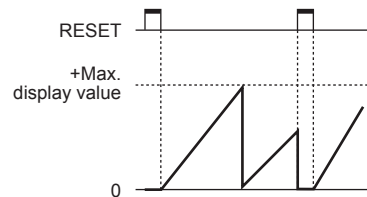

Input mode: Up/Down-A, B, C

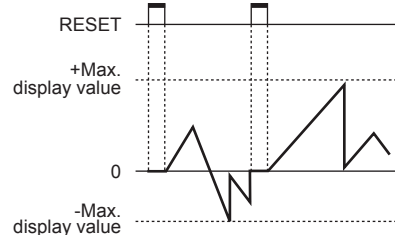

Time operation

Up mode

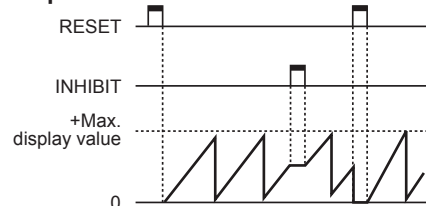

Input mode: Down

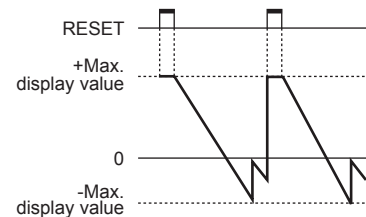

Input mode: Up/Down-D, E, F

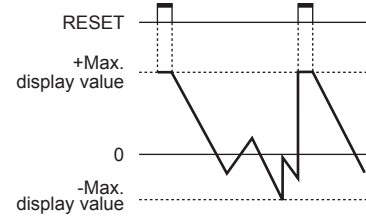

Down mode

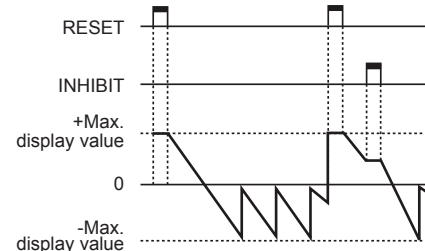

(A) Photoelectric Sensors

(B) Fiber Optic Sensors

(C) Door/Area Sensors

(D) Proximity Sensors

(E) Pressure Sensors

(F) Rotary Encoders

(G) Connectors/ Connector Cables/ Sensor Distribution Boxes/Sockets

(H) Temperature Controllers

(I) SSRs / Power Controllers

(J) Counters

(K) Timers

(L) Panel Meters

(M) Tacho / Speed / Pulse Meters

(N) Display Units

(O) Sensor Controllers

(P) Switching Mode Power Supplies

(Q) Stepper Motors & Drivers & Controllers

(R) Graphic/ Logic Panels

(S) Field Network Devices

(T) Software

Input Operation Mode (counter)

※CP: Clock Pulse













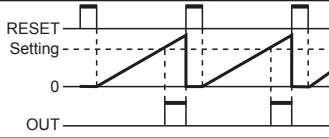
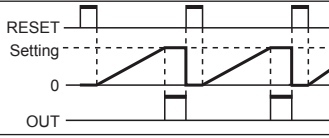
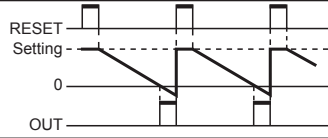
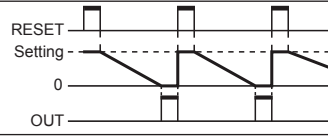

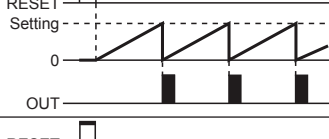
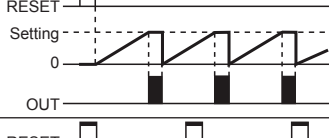
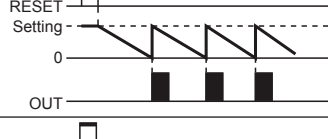



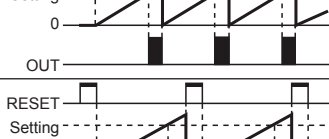
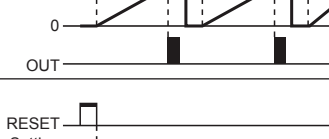
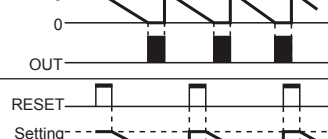



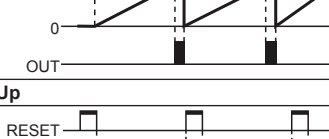
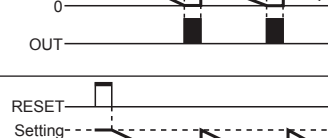
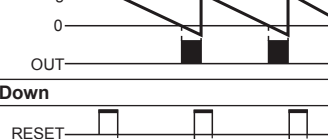

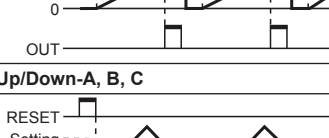
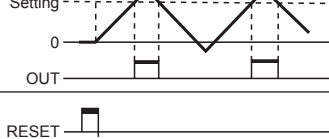

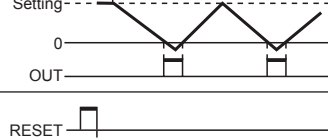

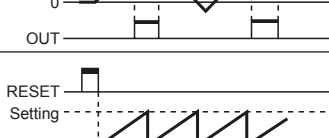
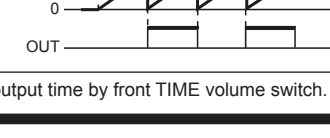
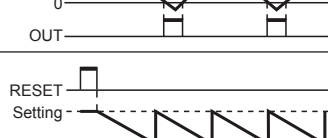
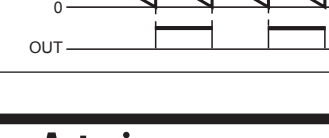

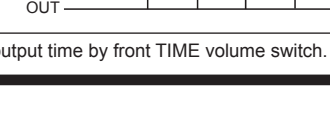
Input mode		SW1	Voltage input (PNP) method	No-voltage input (NPN) method
Up mode ON <input type="checkbox"/> 5 OFF <input type="checkbox"/>	Up/Down-A (command input)	ON <input type="checkbox"/> 4 3 OFF <input type="checkbox"/>		
	Up/Down-B (individual input)	ON <input type="checkbox"/> 4 3 OFF <input type="checkbox"/>		
	Up/Down-C (phase difference input)	ON <input type="checkbox"/> 4 3 OFF <input type="checkbox"/>		
	Up (adding input)	ON <input type="checkbox"/> 4 3 OFF <input type="checkbox"/>		
Down mode ON <input type="checkbox"/> 5 OFF <input type="checkbox"/>	Up/Down-D (command input)	ON <input type="checkbox"/> 4 3 OFF <input type="checkbox"/>		
	Up/Down-E (individual input)	ON <input type="checkbox"/> 4 3 OFF <input type="checkbox"/>		
	Up/Down-F (phase difference input)	ON <input type="checkbox"/> 4 3 OFF <input type="checkbox"/>		
	Down (subtracting input)	ON <input type="checkbox"/> 4 3 OFF <input type="checkbox"/>		

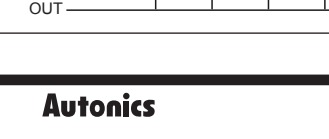
※A: over min. signal width, B: over than 1/2 of min. input signal width. If the signal is smaller than these width, it may cause counting error (± 1).

Up/Down Counter/Timer

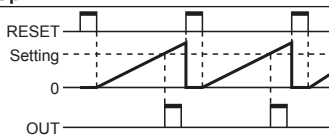
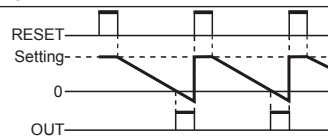
Output Operation Mode

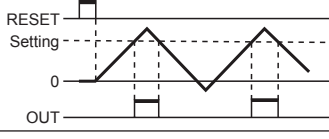
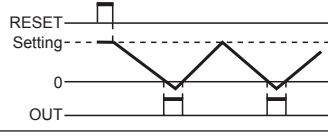
 ← One-shot output (0.05 to 5sec)
  ← Self-holding (hold) output

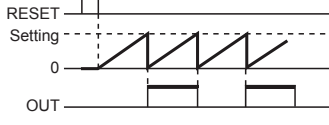
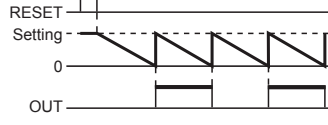
Output mode (SW2)	Up mode		Down mode		Operation
	ON	OFF	ON	OFF	
F	Up, Up/Down-A, B, C		Down, Up/Down-D, E, F		After count-up, counting display value increases or decreases until reset signal input is applied and self-holding output is maintained.
7 6 5 ON  OFF 					
N	Up, Up/Down-A, B, C		Down, Up/Down-D, E, F		After count-up, counting display value and self-holding output are maintained until reset signal input is applied.
7 6 5 ON  OFF 					
C	Up, Up/Down-A, B, C		Down, Up/Down-D, E, F		When count-up, counting display value is reset and it counts simultaneously.
7 6 5 ON  OFF 					
R	Up, Up/Down-A, B, C		Down, Up/Down-D, E, F		After count-up, counting display value is reset after one-shot output time and it counts simultaneously.
7 6 5 ON  OFF 					
K	Up, Up/Down-A, B, C		Down, Up/Down-D, E, F		After count-up, counting display value increases or decreases until reset signal input is applied.
7 6 5 ON  OFF 					
P	Up, Up/Down-A, B, C		Down, Up/Down-D, E, F		After count-up, counting display value is maintained while output is ON. Counting value is internally reset and it counts simultaneously.
7 6 5 ON  OFF 					
Q	Up, Up/Down-A, B, C		Down, Up/Down-D, E, F		After count-up, counting display value increases or decreases during one-shot output time.
7 6 5 ON  OFF 					
S Counter mode	Up		Down		· Up, Up/Down-A, B, C input mode : Output maintains ON when counting display value is larger or equal than setting value.
	7 6 5 ON  OFF 				
S Timer mode	Up/Down-A, B, C		Up/Down-D, E, F		· Down, Up/Down-D, E, F input mode : Output maintains ON when counting display value is smaller or equal than setting value.
	7 6 5 ON  OFF 				
S	Up		Down		Output turns OFF→ON→OFF repeatedly (flicker).
7 6 5 ON  OFF 					

※Set one-shot output time by front TIME volume switch.

- (A) Photoelectric Sensors
- (B) Fiber Optic Sensors
- (C) Door/Area Sensors
- (D) Proximity Sensors
- (E) Pressure Sensors
- (F) Rotary Encoders
- (G) Connectors/ Connector Cables/ Sensor Distribution Boxes/Sockets
- (H) Temperature Controllers
- (I) SSRs / Power Controllers
- (J) Counters
- (K) Timers
- (L) Panel Meters
- (M) Tacho / Speed / Pulse Meters
- (N) Display Units
- (O) Sensor Controllers
- (P) Switching Mode Power Supplies
- (Q) Stepper Motors & Drivers & Controllers
- (R) Graphic/ Logic Panels
- (S) Field Network Devices
- (T) Software

■ Proper Usage

Ⓞ DIP switch setting

Turn OFF the power before setting the DIP switch to the Counter/Timer.

After DIP switch setting when cutting off the power, press the front RESET key or supplying the external reset.

Ⓞ Detaching DIP switch cover

※ Turn OFF the power before detaching the DIP switch cover.

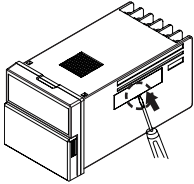

Push and pull the groove of DIP switch cover with a flat head driver to the front. The cover is detached from the case.

▲ Be sure not to be wounded when using a tool.

Ⓞ Error

Display	Error	Troubleshooting
Err0	Setting value is 0.	Change the setting value anything but 0.

※ If error occurs, the output turns OFF.

※ Indicator model does not have error display function.

Ⓞ Power

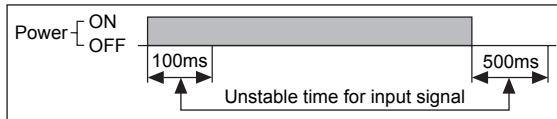

① In case of 24VAC, 24-48VDC model, power supply should be insulated and limited voltage/current or Class 2, SELV power supply device.

② The inner circuit voltage rises within 100ms after supplying the power to the unit. The input may be unavailable at this period. Be sure that the inner circuit voltage drops within 500ms after turning OFF the power.

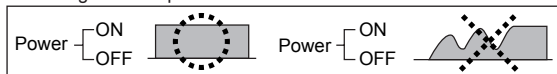

③ Use the unit within the rated power supply. When supplying or cutting the power, use a switch not to occur chattering.

Ⓞ Input signal line

- ① Shorten the cable from the sensor to the unit.
- ② Use shield cable when input cable is longer.
- ③ Wire the input signal line separately from power line.

Ⓞ Testing dielectric voltage or insulation resistance when the unit is installed at control panel

- ① Isolate the unit from the circuit of control panel.
- ② Short all terminals of the unit.

Ⓞ Do not use the unit in the following environments.

- ① Environments with high vibration or shock.
- ② Environments with strong alkali or strong acid materials
- ③ Environments with exposure to direct sunlight
- ④ Near machinery which produces strong magnetic force or electric noise

Ⓞ This product may be used in the following environments.

- ① Indoor
- ② Altitude max. 2,000m
- ③ Pollution degree 2
- ④ Installation category II