

FX Y Series

DIN W72×H36mm Of Counter/Timer With Indication Only

■ Features

- Upgraded counting speed: 1cps/30cps/2kcps/5kcps
- Application of Up/Down input mode
- Selectable Up/Down indication of display value
- Wide range of input power supply:
100-240VAC 50/60Hz
12-24VAC 50/60Hz, 12-24VDC universal
- Selectable Counter or Timer function by internal DIP switch
selectable time ranges
- Built-in Microprocessor



⚠ Please read "Caution for your safety" in operation manual before using.



■ Ordering Information

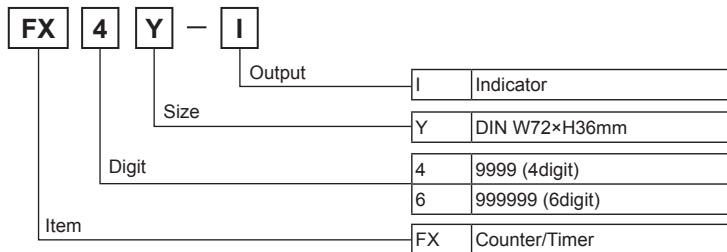

■ Specifications

Model		FX4Y-I	FX6Y-I
Digit		4digit	6digit
Digit size		W8×H14mm	W4×H8mm
Power supply	AC power	100-240VAC 50/60Hz	
	AC/DC power	12-24VAC 50/60Hz, 12-24VDC	
Allowable voltage range		90 to 110% of rated voltage	
Power consumption	AC power	Max. 4.5VA (100-240VAC 50/60Hz)	
	AC/DC power	Max. 4.5VA (12-24VAC 50/60Hz), Max. 2.8W (12-24VDC)	
Max. counting speed		Selectable 1cps/30cps/2kcps/5kcps by internal DIP switch	
Min. input signal width	INHIBIT input	Min. 20ms	
	RESET input		
Input	CP1, CP2 input	No voltage input - Impedance at short-circuit: Max. 470Ω, Residual voltage at short-circuit: Max. 1VDC Impedance at open-circuit: Min. 100kΩ	
	RESET input		
Memory protection		Approx. 10 years (When using non-volatile semiconductor memory)	
External power		12VDC ±10% 50mA Max.	
Insulation resistance		Min. 100MΩ (at 500VDC megger)	
Dielectric strength		2000VAC 50/60Hz for 1 minute	
Noise strength	AC type	±2kV the square wave noise (pulse width: 1μs) by the noise simulator	
	DC type	±500V the square wave noise (pulse width: 1μs) by the noise simulator	
Vibration	Mechanical	0.75mm amplitude at frequency of 10 to 55Hz (for 1 min.) in each X, Y, Z direction for 1hour	
	Malfuction	0.5mm amplitude at frequency of 10 to 55Hz (for 1 min.) in each X, Y, Z direction for 10 min.	
Shock	Mechanical	300m/s ² (approx. 30G) in each X, Y, Z direction for 3 times	
	Malfuction	100m/s ² (approx. 10G) in each X, Y, Z direction for 3 times	
Environ-ment	Ambient temperature	10 to 55°C, storage: -25 to 65°C	
	Ambient humidity	35 to 85%RH, storage: 35 to 85%RH	
Approval		UL US	
Unit weight		Approx. 130g	Approx. 132g

※Environment resistance is rated at no freezing or condensation.

■ Connections

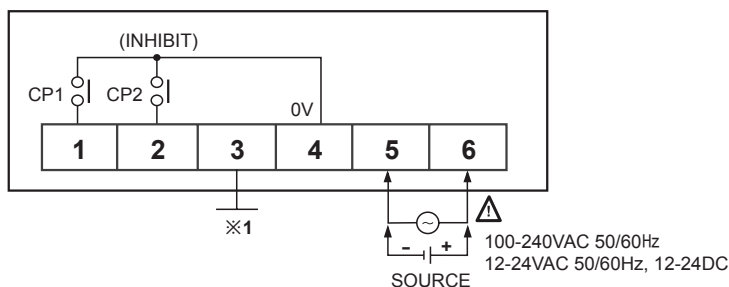

※1: It can be selected RESET or sensor power (+12VDC 50mA) by internal PIN operation. (Refer to J-40)

※CP1, CP2: Input signal terminals when using as counter.

※INHIBIT (CP2): Time Hold terminal when using for timer (Connect switch to ②+④ from the external.)

※Operated by a Power ON Start method when it is used as a timer.

■ Input Connections

◎ Using for no-voltage input (NPN)

● Solid-state input (Standard sensor: NPN output type sensor)

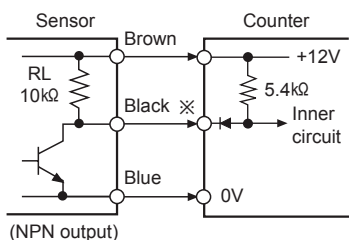

※CP1, CP2 (INHIBIT), RESET input

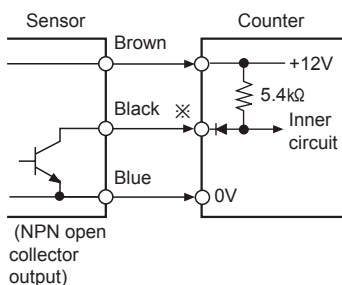

● Contact input

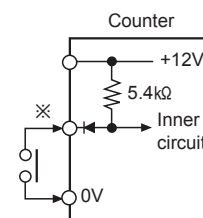

※Please select the counting speed as 30cps when using for counter.

◎ Using for voltage input (PNP)

FXY series is for no-voltage input type, it is not available to count applying DC voltage from the external.

For using PNP type sensor, please use as the following to count.

● PNP output type sensor

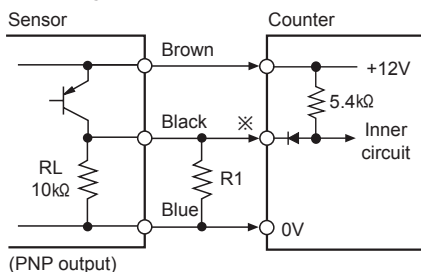

※Please set R1 value to make the composed resistance of $RL + R1$ as Max. 470kΩ is an impedance for short-circuit.

※CP1, CP2 (INHIBIT), RESET input

● PNP open collector output type sensor

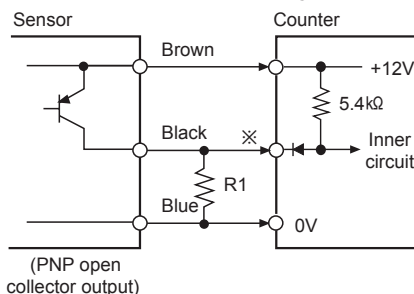

※In case of PNP open collector output type sensor, please connect lower than 470Ω of R1 to input terminal before using.

(A) Photoelectric Sensors

(B) Fiber Optic Sensors

(C) Door/Area Sensors

(D) Proximity Sensors

(E) Pressure Sensors

(F) Rotary Encoders

(G) Connectors/ Sockets

(H) Temperature Controllers

(I) SSRs / Power Controllers

(J) Counters

(K) Timers

(L) Panel Meters

(M) Tacho / Speed / Pulse Meters

(N) Display Units

(O) Sensor Controllers

(P) Switching Mode Power Supplies

(Q) Stepper Motors & Drivers & Controllers

(R) Graphic/ Logic Panels

(S) Field Network Devices

(T) Software

FX Series

Counting Method

Be careful to select sensor because the counting method of NPN output type sensor is different from PNP output type sensor.

● NPN output type sensor

: When the sensor is changed from OFF to ON, it counts.

● PNP output type sensor

: When the sensor is changed from ON to OFF, it counts.

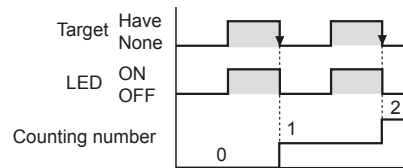
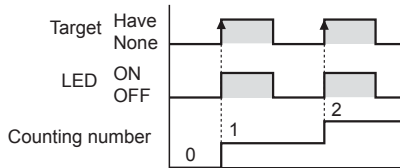
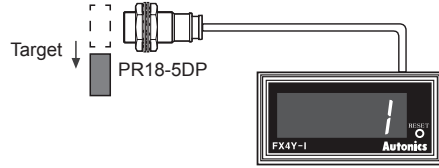
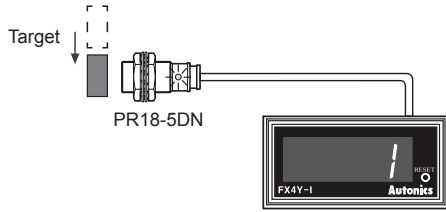

Dimensions

(unit: mm)

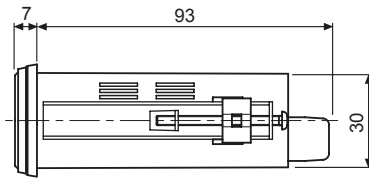
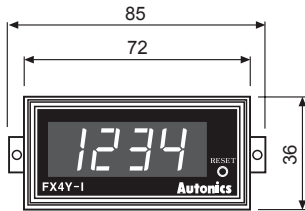

● Panel cut-out

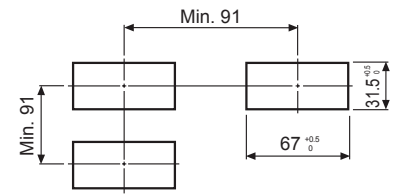

Counting Operation Of Indication Type (Counter)

● Up mode

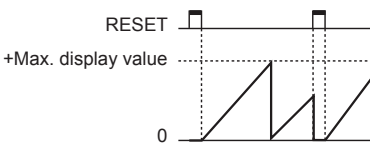

● Down mode

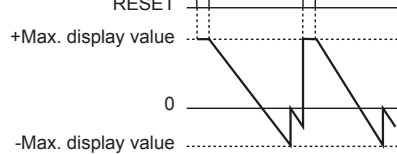

● Up/Down-A, B, C mode

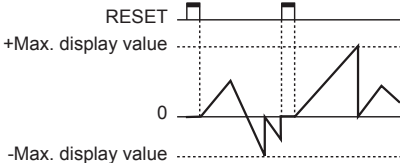

● Up/Down-D, E, F mode

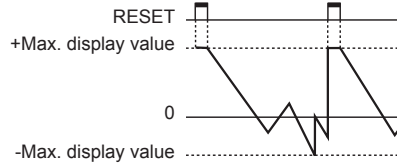

Counting Operation Of Indication Type (Timer)

● Up mode

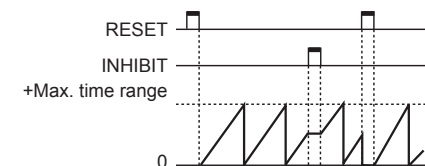

● Down mode

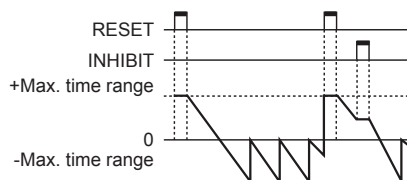

Up/Down Counter/Timer

■ Description Of Inner DIP Switches

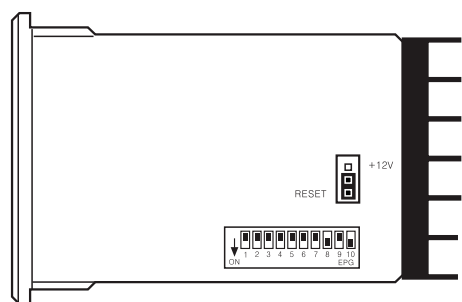

※ Inner selection switch is changed from 8pin to 10pin with upgrade of counting speed.

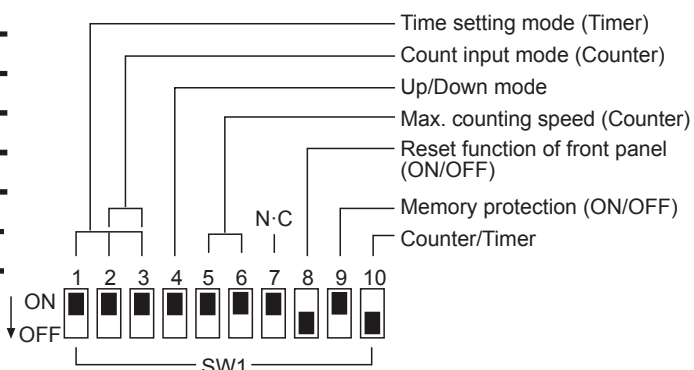

● Up/Down mode

SW1	Function
4	ON <input type="checkbox"/> OFF <input type="checkbox"/>
	Up mode
4	ON <input type="checkbox"/> OFF <input type="checkbox"/>
	Down mode

● Counter/Timer

SW1	Function
10	ON <input type="checkbox"/> OFF <input type="checkbox"/>
	Timer
10	ON <input type="checkbox"/> OFF <input type="checkbox"/>
	Counter

● Reset function of front panel (ON/OFF)

SW1	Function
8	ON <input type="checkbox"/> OFF <input type="checkbox"/>
	Disable the front panel reset function
8	ON <input type="checkbox"/> OFF <input type="checkbox"/>
	Enable the front panel reset function

● Max. counting speed

SW1	CP1, CP2
5 6	ON <input type="checkbox"/> OFF <input type="checkbox"/>
	1cps
5 6	ON <input type="checkbox"/> OFF <input type="checkbox"/>
	30cps
5 6	ON <input type="checkbox"/> OFF <input type="checkbox"/>
	2kcps
5 6	ON <input type="checkbox"/> OFF <input type="checkbox"/>
	5kcps

● Memory protection (ON/OFF)

SW1	Function
9	ON <input type="checkbox"/> OFF <input type="checkbox"/>
	Enable the memory protection
9	ON <input type="checkbox"/> OFF <input type="checkbox"/>
	Disable the memory protection

■ Time Setting Mode (Timer)

SW1	4digit	6digit	SW1	4digit	6digit
ON <input type="checkbox"/> OFF <input type="checkbox"/>	99.99sec	99999.9sec	ON <input type="checkbox"/> OFF <input type="checkbox"/>	999.9min	99999.9min
ON <input type="checkbox"/> OFF <input type="checkbox"/>	999.9sec	999999sec	ON <input type="checkbox"/> OFF <input type="checkbox"/>	99hour 59min	99hour 59min 59sec
ON <input type="checkbox"/> OFF <input type="checkbox"/>	9999sec	99min 59.99sec	ON <input type="checkbox"/> OFF <input type="checkbox"/>	999.9hour	9999hour 59min
ON <input type="checkbox"/> OFF <input type="checkbox"/>	99min 59sec	999min 59.9sec	ON <input type="checkbox"/> OFF <input type="checkbox"/>	9999hour	99999.9hour

(A) Photoelectric Sensors

(B) Fiber Optic Sensors

(C) Door/Area Sensors

(D) Proximity Sensors

(E) Pressure Sensors

(F) Rotary Encoders

(G) Connectors/ Sockets

(H) Temperature Controllers

(I) SSRs / Power Controllers

(J) Counters

(K) Timers

(L) Panel Meters

(M) Tacho / Speed / Pulse Meters

(N) Display Units

(O) Sensor Controllers

(P) Switching Mode Power Supplies

(Q) Stepper Motors & Drivers & Controllers

(R) Graphic/ Logic Panels

(S) Field Network Devices

(T) Software

FXY Series

Input Mode (Counter)

Input mode	SW1	ON <input checked="" type="checkbox"/> Up mode OFF <input type="checkbox"/>	Input mode	SW1	ON <input type="checkbox"/> OFF <input checked="" type="checkbox"/> Down mode
Up/Down-A (Command input)	ON <input checked="" type="checkbox"/> <input checked="" type="checkbox"/> OFF <input type="checkbox"/> <input type="checkbox"/>		Up/Down-D (Command input)	ON <input checked="" type="checkbox"/> <input checked="" type="checkbox"/> OFF <input type="checkbox"/> <input type="checkbox"/>	
Up/Down-B (Individual input)	ON <input type="checkbox"/> <input checked="" type="checkbox"/> OFF <input checked="" type="checkbox"/> <input type="checkbox"/>		Up/Down-E (Individual input)	ON <input type="checkbox"/> <input checked="" type="checkbox"/> OFF <input checked="" type="checkbox"/> <input type="checkbox"/>	
Up/Down-C (Phase difference input)	ON <input checked="" type="checkbox"/> <input checked="" type="checkbox"/> OFF <input type="checkbox"/> <input checked="" type="checkbox"/>		Up/Down-F (Phase difference input)	ON <input type="checkbox"/> <input checked="" type="checkbox"/> OFF <input checked="" type="checkbox"/> <input type="checkbox"/>	
UP (Count up input)	ON <input type="checkbox"/> <input checked="" type="checkbox"/> OFF <input checked="" type="checkbox"/> <input checked="" type="checkbox"/>		Down (Count down input)	ON <input checked="" type="checkbox"/> <input type="checkbox"/> OFF <input type="checkbox"/> <input checked="" type="checkbox"/>	

※Ⓐ: Over min. signal width, Ⓑ: Over 1/2 of min. signal width.

If the signal width of Ⓐ or Ⓑ is less than min. signal width, ±1 of count error occurs.

※n: + max. display value (FX4Y-I: 9999, FX6Y-I: 999999)

■ Proper Usage

○ Reset

● Reset

When selecting a reset input/output mode, please apply the external reset or manual reset signal.

If it is not reset, it is operated as the prior mode.

● Reset signal width

It is reset perfectly when the reset signal is applied for **min. 20ms** regardless of the contact input & solid-state input.

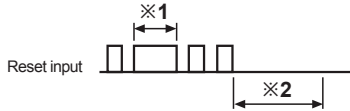

※1: In case of a contact reset, it is reset perfectly if the ON time of reset signal is applied for min. 20ms even though a chattering occurs.

※2: Signal input (CP1, CP2) is possible if there is no reset input for min. 50ms after reset input.

○ Min. signal width

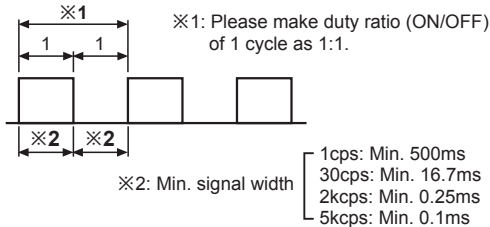

○ Max. counting speed

This is a response speed per 1 sec. when the duty ratio (ON:OFF) of input signal is 1:1.

If the duty ratio is not 1:1, the width between ON and OFF should be over min. signal width and the response speed will get slower against input signal. And one of ON width and OFF width is under min. signal width, this product may not respond.

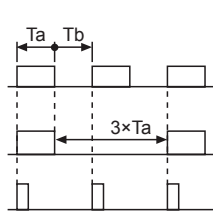

○ Detach the case from body

While pushing the Lock part with driver to the front, push the terminal block.

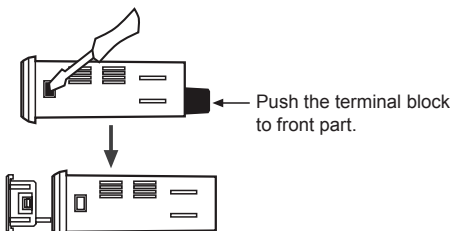

※Be careful not to be wounded by tools.

○ Using switching pin of Reset / +12V

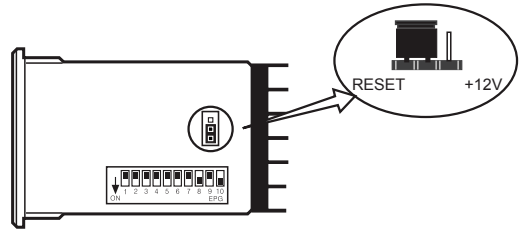

● When using terminal 3 for external reset terminal

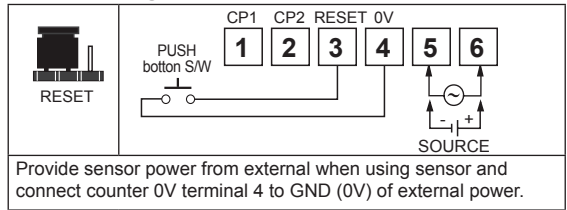

● When using terminal 3 for sensor power terminal

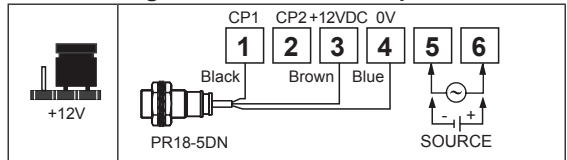

○ INHIBIT [For timer]

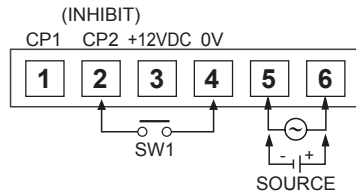

- It becomes the INHIBIT mode when SW1 turns on. (Time Hold)
- When power is applied, it starts to progress and INHIBIT mode is used to stop the time is under the progress at the moment.
- When SW1 is OFF, timer starts to progress again.

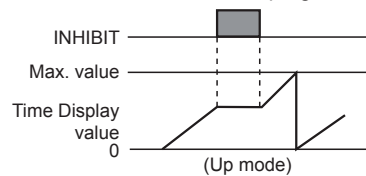

○ Power

The inner circuit voltage starts to rise up for the first 100ms after power on, the input may not work at this time. And also the inner circuit voltage drops down for the last 500ms after power off, the input may not work at this time.

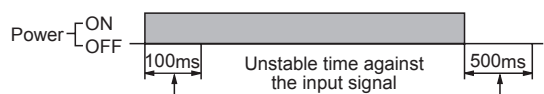

(A) Photoelectric Sensors

(B) Fiber Optic Sensors

(C) Door/Area Sensors

(D) Proximity Sensors

(E) Pressure Sensors

(F) Rotary Encoders

(G) Connectors/Sockets

(H) Temperature Controllers

(I) SSRs / Power Controllers

(J) Counters

(K) Timers

(L) Panel Meters

(M) Tacho / Speed / Pulse Meters

(N) Display Units

(O) Sensor Controllers

(P) Switching Mode Power Supplies

(Q) Stepper Motors & Drivers & Controllers

(R) Graphic/Logic Panels

(S) Field Network Devices

(T) Software