

Autonics TIMER LE4S INSTRUCTION MANUAL



Thank you for choosing our Autonics product.
Please read the following safety considerations before use.

Safety Considerations

- ⚠ Please observe all safety considerations for safe and proper product operation to avoid hazards.
- ⚠ symbol represents caution due to special circumstances in which hazards may occur.
- ⚠ **Warning** Failure to follow these instructions may result in serious injury or death.
- ⚠ **Caution** Failure to follow these instructions may result in personal injury or product damage.

Warning

- Fail-safe device must be installed when using the unit with machinery that may cause serious injury or substantial economic loss. (e.g. nuclear power control, medical equipment, ships, vehicles, railways, aircraft, combustion apparatus, safety equipment, crime/disaster prevention devices, etc.)
Failure to follow this instruction may result in fire, personal injury, or economic loss.
- Install on a device panel to use.
Failure to follow this instruction may result in electric shock or fire.
- Do not connect, repair, or inspect the unit while connected to a power source.
Failure to follow this instruction may result in electric shock or fire.
- Check 'Connections' before wiring.
Failure to follow this instruction may result in fire.
- Do not disassemble or modify the unit.
Failure to follow this instruction may result in electric shock or fire.

Caution

- When connecting the power/sensor input and relay output, use AWG 20(0.50mm²) cable or over and tighten the terminal screw with a tightening torque of 0.74 to 0.90N·m.
Failure to follow this instruction may result in fire or malfunction due to contact failure.
- Use the unit within the rated specifications.
Failure to follow this instruction may result in fire or product damage.
- Use dry cloth to clean the unit, and do not use water or organic solvent.
Failure to follow this instruction may result in electric shock or fire.
- Do not use the unit in the place where flammable/explosive/corrosive gas, humidity, direct sunlight, radiant heat, vibration, impact, or salinity may be present.
Failure to follow this instruction may result in fire or explosion.
- Keep metal chip, dust, and wire residue from flowing into the unit.
Failure to follow this instruction may result in fire or product damage.

Ordering Information

Output	Time limit contact 1c
Size	A Time limit contact 2c, Instantaneous contact 1c + Time limit contact 1c(Selectable)
Digit	S DIN W48mm×H48mm
Item	4 9999(4 Digit type)
Display	E Timer
	L LCD Display

※8 Pin socket(PG-08, PS-08): Sold separately

Dimensions

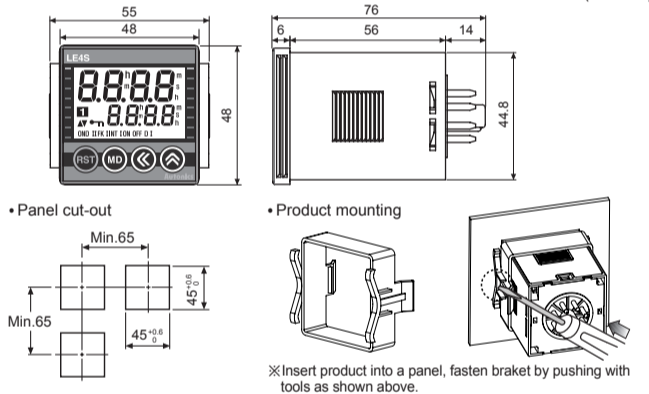

Specifications

Model	LE4S
Power supply	24-240VAC~ 50/60Hz, 24-240VDC=
Display method	LCD Display (backlight)
Allowable voltage range	90 to 110% of rated voltage
Power consumption	24-240VAC~: max. 4.5VA, 24-240VDC=: max. 2W
Return time	Max. 100ms
Min. input signal (START,INHIBIT,RESET)	1ms, 20ms (selectable)
Input (START,INHIBIT,RESET)	<No-voltage input> Impedance at short-circuit: max. 1kΩ, Residual voltage: max. 0.5VDC, Impedance at open-circuit: min. 100kΩ
Control output	Contact Type Capacity 250VAC~ 5A resistive load
Repeat Setting-Voltage-Temperature error	Max. ±0.005% ±0.03sec (Signal Start) Max. ±0.01% ±0.05sec (Power ON Start)
Environment	Ambient temp. -10 to 55°C, storage: -25 to 65°C Ambient humi. 35 to 85%RH
Insulation resistance	Over 100MΩ (500VDC megger)
Dielectric strength	2,000VAC 50/60Hz for 1 minute
Vibration	Mechanical 0.75mm amplitude at frequency of 10 to 55Hz in each X, Y, Z direction for 1 hour Malfunction 0.5mm amplitude at frequency of 10 to 55Hz in each X, Y, Z direction for 10 minutes
Shock	Mechanical 300m/s ² (30G) X, Y, Z directions for 3 times Malfunction 100m/s ² (10G) X, Y, Z directions for 3 times
Relay life cycle	Mechanical Min. 10,000,000 times Electrical Min. 100,000 times (250VAC 5A resistive load)
Approval	CE, RoHS
Unit weight	Approx. 98g

※Environment resistance is rated at no freezing or condensation.

Input Connections

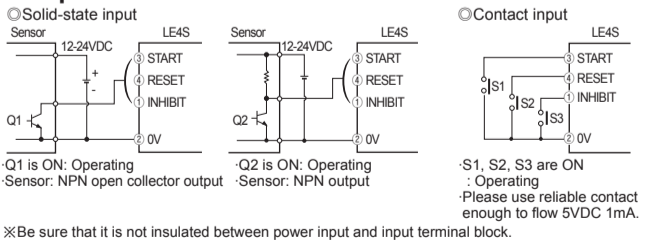

Connection

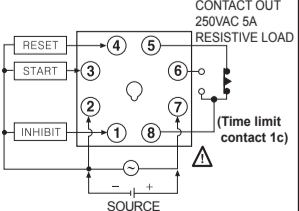

Factory Default

NO.	Parameter	Default
1	Output operation mode	o u t . n o n d
2	Time Range	t . r n g 99.99s
3	Time Up/Down	u - d u p
4	Min. input signal	i n t 20
5	Backlight	b l u o n
6	Key Lock	l o c k L o f f
7	Setting time	- 50.00s

※The above specifications are subject to change and some models may be discontinued without notice.
※Be sure to follow cautions written in the instruction manual and the technical descriptions (catalog, homepage).

Front Panel Identification

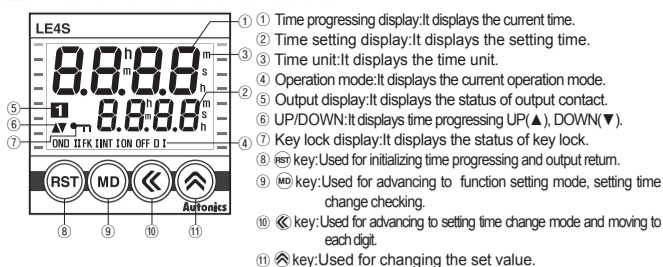

Function Setting Mode Descriptions

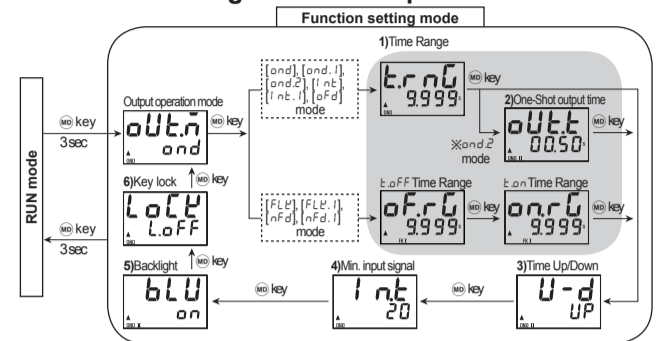

1) Time Range

Parameter	Time range specification
9.999s(9.999s)	0.010 sec to 9.999 sec
99.99s(99.99s)	0.01 sec to 99.99 sec
999.9s(999.9s)	0.1 sec to 999.9 sec
9999s(9999s)	1 sec to 9999 sec
99.99m(99m59s)	0 min 01 sec to 99 min 59 sec
999.9m(999.9m)	0.1 min to 999.9 min
9999m(9999m)	1 min to 9999 min
99.99h(99h59m)	0 hour 01 min to 99 hour 59 min
999.9h(999.9h)	0.01 hour to 999.9 hour
9999h(9999h)	1 hour to 9999 hour

2) One-Shot output time setting

It will be activated when selecting ON Delay 2[ond.2] output operation mode (One-Shot-output mode).
(Time setting: 0.01 sec to 99.99 sec)

3) Time progress UP/DOWN setting

UP[UP]: Time progressed from 0 to setting time.
DOWN[DN]: Time progressed from setting time to 0.

4) The minimum input signal setting

Set the minimum input signal of RESET, START and INHIBIT.
Min. input signal: Choose 1ms and 20ms

5) Backlight setting

Set Backlight (ON[on], OFF[off]).

6) Key Lock selection

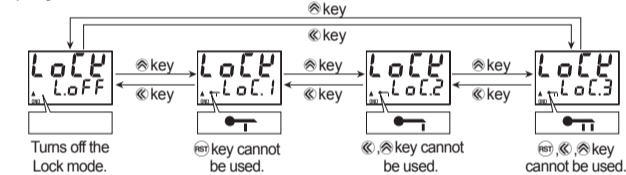

Time Setting

Output operation mode : OND, OND I, OND II, INT, INT I, OFF D

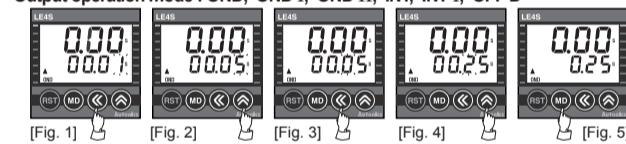

Output operation mode : FK, FK I

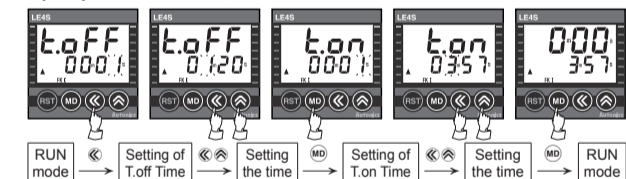

Output operation mode : ON OFF D, ON OFF D I

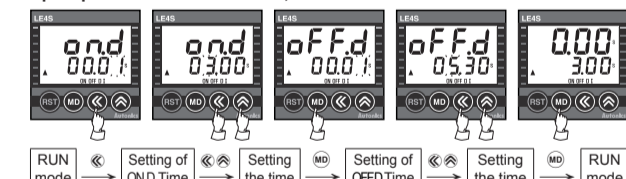

※It is able to change the setting time during the time progressing, but be sure about the time progressing while changing of the time.
※If pressing key while setting time is shorter than min. setting time, setting value will be flickering three times and it will be returned to setting mode again, not to RUN mode.
※If there is no additional key operations after entering into setting mode, it will be return to RUN mode. (Setting value is not saved.)
※Min. Setting time: 0.01 sec.
(In case of OND, OND I and OND II modes, it is able to set 0 since no min. setting time is applied.)

Cautions during Use

- Follow instructions in 'Cautions during Use'. Otherwise, it may cause unexpected accidents.
- When supplying or turning off the power, use a switch or etc. to avoid chattering.
- Install a power switch or circuit breaker in the easily accessible place for supplying or disconnecting the power.
- In order to block peripheral current, use isolation transformer which of secondary part is not grounded as (Figure 1) to supply power to the external input device.

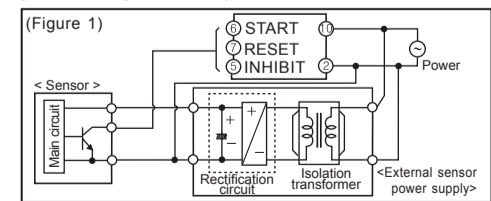

- Do not connect two or more timers with only one input contact or transistor simultaneously.
- Keep away from high voltage lines or power lines to prevent inductive noise.
- In case installing power line and input signal line closely, use line filter or varistor at power line and shielded wire at input signal line.
- Do not use near the equipment which generates strong magnetic force or high frequency noise.
- This unit may be used in the following environments.
 - Indoors (in the environment condition rated in 'Specifications')
 - Altitude max. 2,000m
 - Pollution degree 2
 - Installation category II

Output Operation Mode

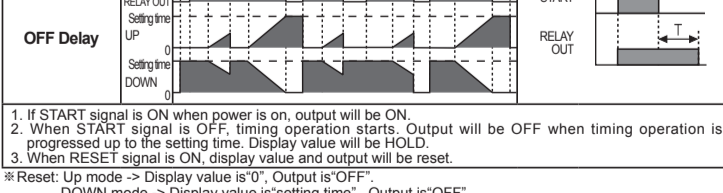
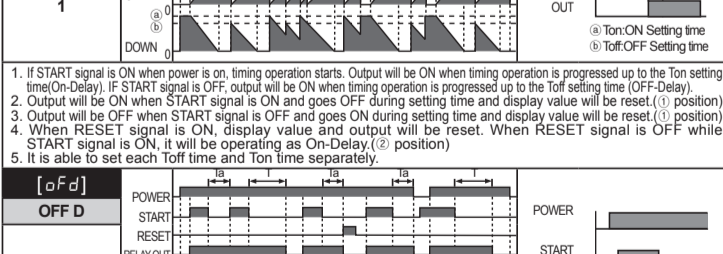
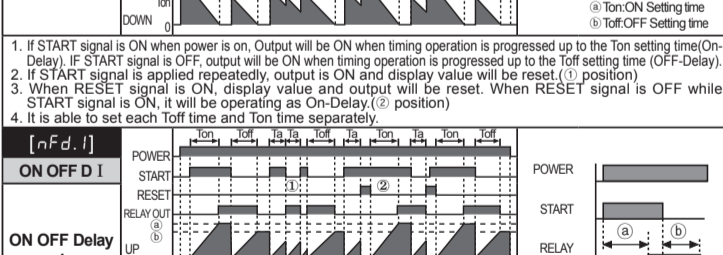
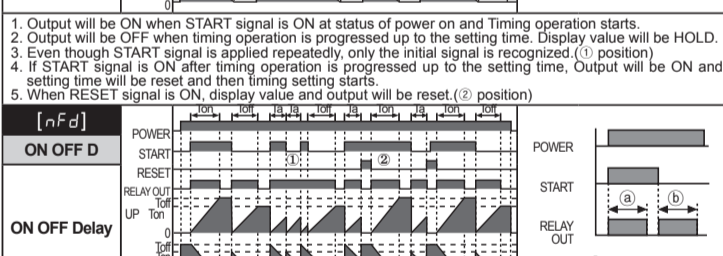
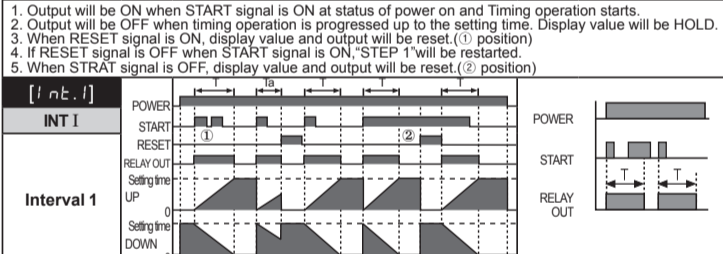
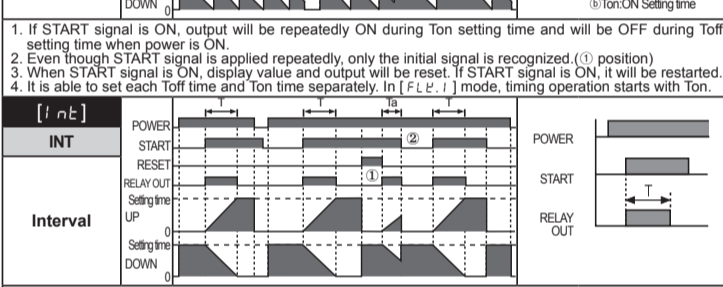
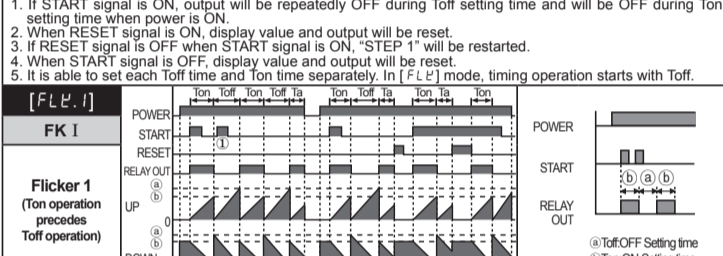
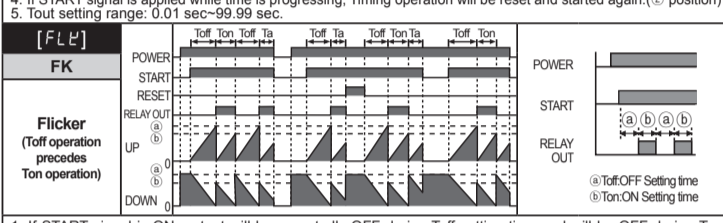
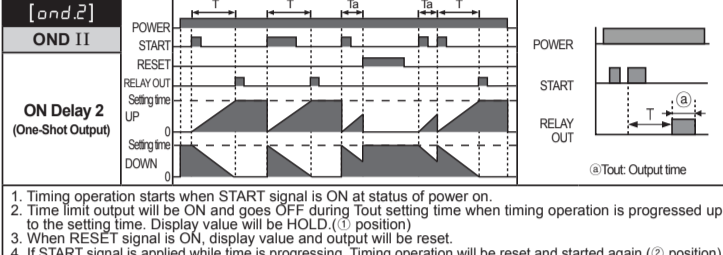
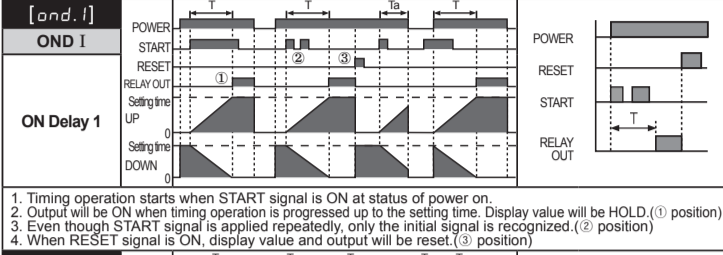
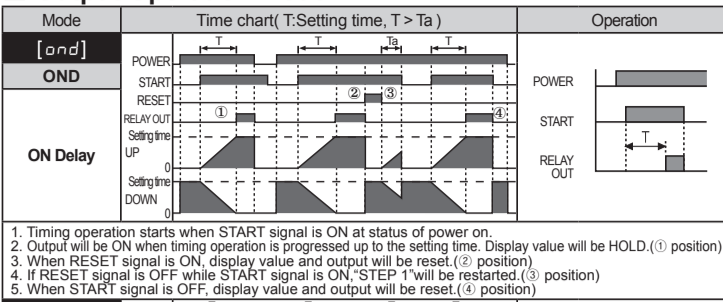

Major Products

- Photoelectric Sensors
- Fiber Optic Sensors
- Door Sensors
- Door Side Sensors
- Area Sensors
- Proximity Sensors
- Pressure Sensors
- Rotary Encoders
- Switching Mode Power Supplies
- Control Switches/Lamps/Buzzers
- Terminal Blocks & Cables
- Stepper Motors/Drivers/Motion Controllers
- Graphic/Logic Panels
- Field Network Devices
- Laser Marking System (Fiber, Co., Nd: YAG)
- Laser Welding/Cutting System
- Temperature Controllers
- Temperature/Humidity Transducers
- SSR/Power Controllers
- Counters
- Timers
- Panel Meters
- Tachometer/Pulse (Rate)/Meters
- Display Units
- Sensor Controllers

Autonics Corporation
http://www.autonics.com

HEADQUARTERS:
18, Banson-ro 513beon-gil, Haeundae-gu, Busan,
South Korea, 48002
TEL: 82-51-519-3232
E-mail: sales@autonics.com