

## Single-Phase, Power Controller

### ■ Features

- **Various and simple input specification**
  - DC4-20mA, 1-5VDC, External 24VDC
  - External adjuster (1kΩ)
  - External contact (ON/OFF)
- **Various function**
  - OUT ADJ (output limit) function
  - SOFT START function (except for ON/OFF control method)
  - OUT display function
  - 50/60Hz automatic converting function
- **Various control method by switch**
  - Phase control method
  - Cycle control method (zero cross turn-on)
  - ON/OFF control method (zero cross turn-on)

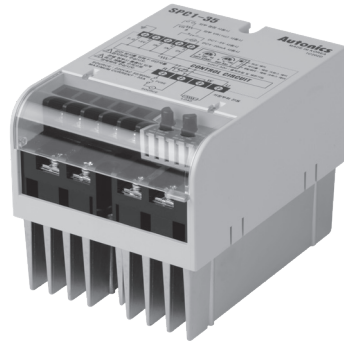

**⚠ Please read "Safety considerations" in operation manual before using.**

### ■ Ordering Information

<b>SPC</b>	<b>1</b>	<b>-</b>	<b>35</b>	<b>-</b>	<b>E</b>	
Item	Control phase		Rated load current		Marking language	
			35	50	E	English
			35A	50A		
			1			Single-phase
			SPC			Solid state power controller

### ■ Specifications

Model	SPC1-35-E	SPC1-50-E
Power supply	220VAC~ 50/60Hz	
Allowable voltage range	90 to 110% of rated voltage	
Operating frequency fluctuation	±1Hz	
Rated load current	35A (single-phase)	50A (single-phase)
Control power	220VAC~	
Control range	Phase control: 0 to 98%, Cycle control: 0 to 100%	
Applied load	Resistance load (min. load: over 5% of rated current)	
Cooling method	Natural cooling	
Control circuit	Micom control type	
Control input	• 1-5VDC=      • DC4-20mA (250Ω)      • ON/OFF (external relay contact or 24VDC=) • External adjuster (1kΩ)      • Output limit input (front OUT ADJ. adjuster)	
Control method	By selection switch	• Phase control <sup>※1</sup> • Cycle control (zero cross turn-on) - Period 0.5 sec, 2.0 sec, 10 sec <sup>※1</sup> • ON/OFF control (zero cross turn-on)
Starting type	SOFT START (0 to 50 sec variable)	
Indicator	Output indicator (OUT): red LED	
Insulation resistance	Over 100MΩ (at 500VDC megger)	
Dielectric strength	2000VAC 50/60Hz for 1minute	
Noise immunity	±2kV the square wave noise (pulse width: 1us) by the noise simulator	
Vibration	Mechanical	0.75mm amplitude at frequency of 10 to 55Hz (for 1 min) in each X, Y, Z direction for 1 hour
	Malfunaction	0.5mm amplitude at frequency of 10 to 55Hz (for 1 min) in each X, Y, Z direction for 10 min
Shock	Mechanical	300m/s <sup>2</sup> (approx. 30G) in each X, Y, Z direction for 3 times
	Malfunaction	100m/s <sup>2</sup> (approx. 10G) in each X, Y, Z direction for 3 times
Environment	Ambient temp.	0 to 50°C, storage: -25 to 65°C
	Ambient humi.	35 to 85%RH, storage: 35 to 85%RH
Wire specification	AWG16 to 8	AWG8 to 6
Unit weight	Approx. 1kg	

※1: Refer to '■ Operation and Function'.

※Environment resistance is rated at no freezing or condensation.

(A) Photoelectric Sensors

(B) Fiber Optic Sensors

(C) Door/Area Sensors

(D) Proximity Sensors

(E) Pressure Sensors

(F) Rotary Encoders

(G) Connectors/ Connector Cables/ Sensor Distribution Boxes/Sockets

(H) Temperature Controllers

(I) SSRs / Power Controllers

(J) Counters

(K) Timers

(L) Panel Meters

(M) Tacho / Speed / Pulse Meters

(N) Display Units

(O) Sensor Controllers

(P) Switching Mode Power Supplies

(Q) Stepper Motors & Drivers & Controllers

(R) Graphic/ Logic Panels

(S) Field Network Devices

(T) Software

# SPC1 Series

## ■ Dimensions

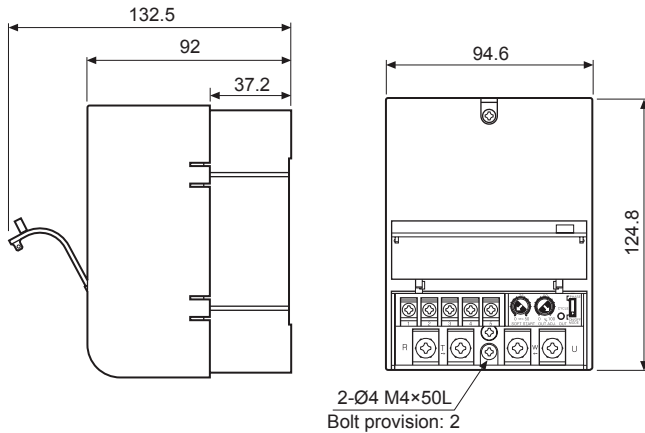

(unit: mm)

## ● Spacing

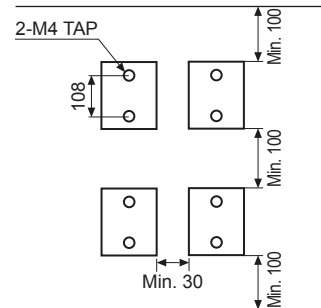

※When installing multiple power controllers, please keep space at least 30mm in horizontal and 100mm in vertical between power controllers for heat radiation.

## ■ Connections

### 1. External connection

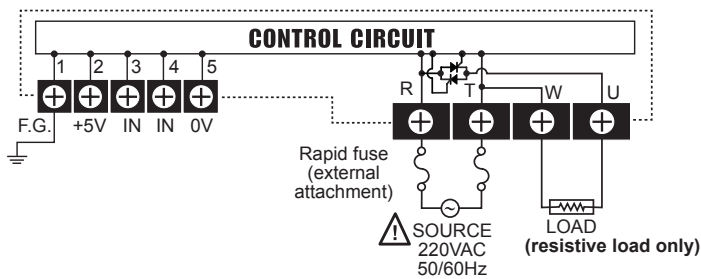

### 2. Connection of control input terminals

#### 1) DC4-20mA control input

It controls 0 to 100% when you apply DC4-20mA on ④, ⑤ terminals when power is applied.

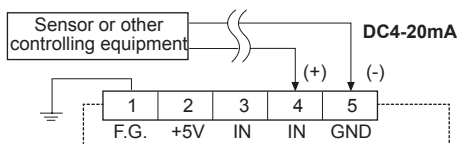

※This function must not be used in ON/OFF control method.

#### 2) 1-5VDC control input

It controls 0 to 100% when you apply 1-5VDC on ③, ⑤ terminals when power is applied.

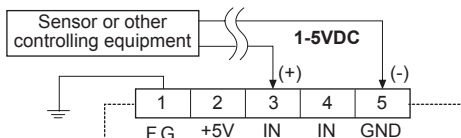

※This function must not be used in ON/OFF control method.

#### 3) ON/OFF external contact control input

It controls 100% if you connect external contact or switch to ②, ③ terminal when it is ON, it controls 0% when it is OFF.

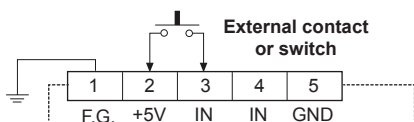

※It is available for all control methods.  
OUT ADJ and SOFT START functions are not available in ON/OFF control method.

# Single-Phase, Power Controller

## 4) External adjuster control input

After power is applied, connecting the external adjuster 1kΩ to ②, ③ and ⑤ terminals and turning adjuster control from 0% to 100%.

It is available to control as OUT ADJ, adjuster for the above 1), 2), 3) and set at 100% when it is not used.

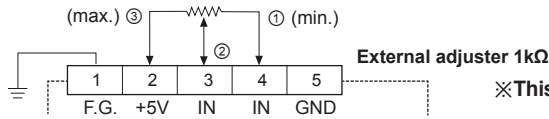

※This function must not be used in ON/OFF control method.

## 5) External 24VDC control input

It can be used with external 24VDC voltage as below.

It is available to control of ON/OFF, outputs 100% for applying 24VDC and 0% for applying 0VDC.

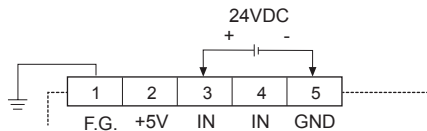

※It is available for all control methods.

OUT ADJ and SOFT START functions are not available in ON/OFF control method.

※Tighten the terminal screw with the below tightening torque.

※Use terminals of size specified below.

Terminal type	Signal input (control input)	Output and power
Screw	M3.5	M5
Tightening torque	0.6 to 1.2N·m	1.5 to 2.2N·m

Terminal type	Signal input (control input)	Output and power
a	Min. 3.5mm	Min. 5mm
b	Max. 7.0mm	Max. 12mm

## Unit Description

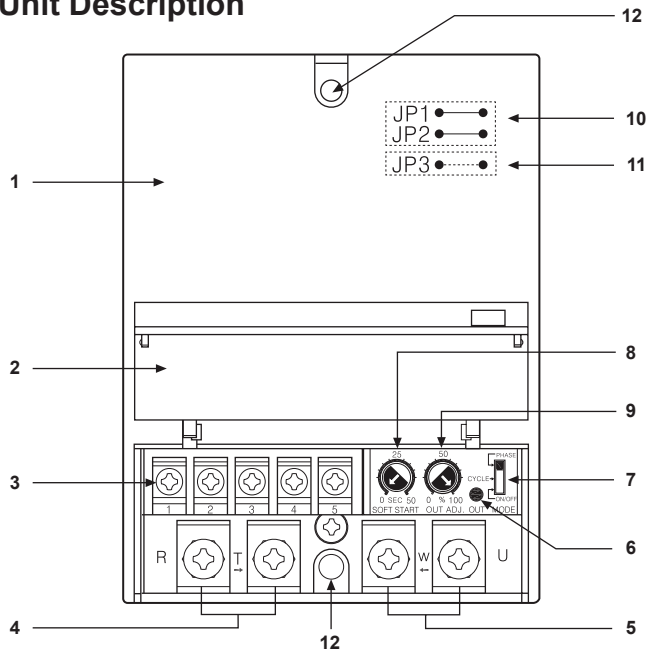

### 1. Case

### 2. Terminal block cover

### 3. Terminal block for control input

### 4. Terminal block of the power

### 5. Terminal block for load connection

### 6. Output indicator (OUT)

### 7. Control method selection switch

### 8. SOFT START setting adjuster

### 9. Output limit setting adjuster

### 10. Selection jumper of control period

### 11. Selection jumper of control mode

(bolt size: M4×50mm)

※10, 11 are placed on the inner PCB of the product.

## Factory Default

Control method	Phase control
Control mode	Phase equal division type according to control input
Control cycle period	0.5 sec (JP1, JP2 short)
SOFT START setting	0 sec
OUT ADJ. setting	100%

(A) Photoelectric Sensors

(B) Fiber Optic Sensors

(C) Door/Area Sensors

(D) Proximity Sensors

(E) Pressure Sensors

(F) Rotary Encoders

(G) Connectors/ Connector Cables/ Sensor Distribution Boxes/Sockets

(H) Temperature Controllers

(I) SSRs / Power Controllers

(J) Counters

(K) Timers

(L) Panel Meters

(M) Tacho / Speed / Pulse Meters

(N) Display Units

(O) Sensor Controllers

(P) Switching Mode Power Supplies

(Q) Stepper Motors & Drivers & Controllers

(R) Graphic/ Logic Panels

(S) Field Network Devices

(T) Software

# SPC1 Series

## Operation and Function

### Front

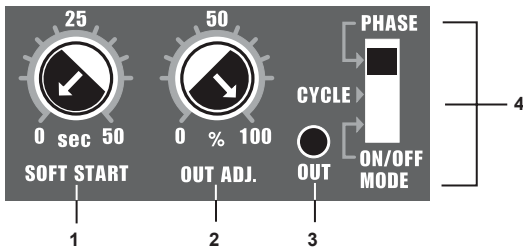

1. SOFT START setting adjuster (0 to 50 sec)
2. Output limit setting adjuster (0 to 100%)
3. Output indicator
4. Control method selection switch
  - PHASE: Phase control method
  - CYCLE: Cycle control method
  - ON/OFF: ON/OFF control method

### Control method selection

Control method	Phase control	Cycle control (zero cross turn-on)	ON/OFF control (zero cross turn-on)
Switch			

※When selecting cycle control method, the cycle has been set as 0.5 sec. It can be changed to 2 sec, 10 sec by selection.  
 ※The control method setting cannot be changed while it is operating. **Turn OFF the power at first** then change the setting and supply the power again.

#### 1) Phase control

It is output type to control phase of an alternating signal according to control input signal.

##### ● Equal division type of phase according as control input

This is analog type to output control angle with dividing equally according as control input signal. It shows power characteristic as (Fig. 1) and it might occur over power and lack power at point middle of control input.

##### ● Equal division type of power according as control input

It divides control angle non-equally according as control input signal then make power curve linearization, so it becomes possible to output the power, which is proportioned control input as outputting (Fig. 1).

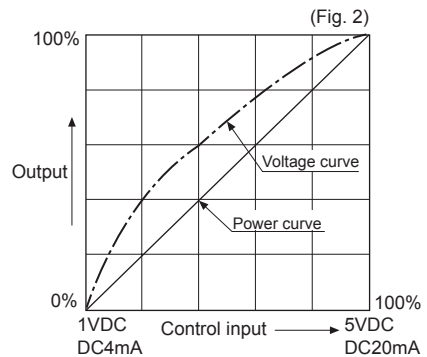
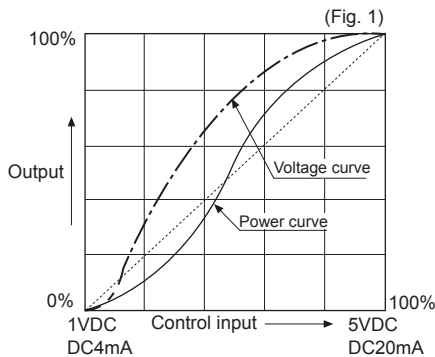

※To change the control mode, change TP3 of PCB as below.

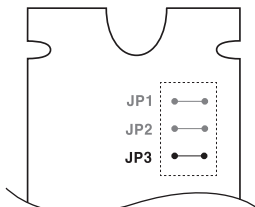

JP3	Division method (control mode)
SHORT	Equal division of phase according as control input
OPEN	Equal division of power according as control input

※ SHORT      OPEN

#### 2) Cycle control (fixed cycle) - Zero cross turn-on

It controls the power, which is applied into the load to repeat ON/OFF cycle like below picture with constant proportion according to control input signal. It is easy to control the load and there is no ON/OFF noise because it turns ON and OFF at the zero point of AC.

Usually it is used in a place or electric furnace which is not easily effected by external noise.

# Single-Phase, Power Controller

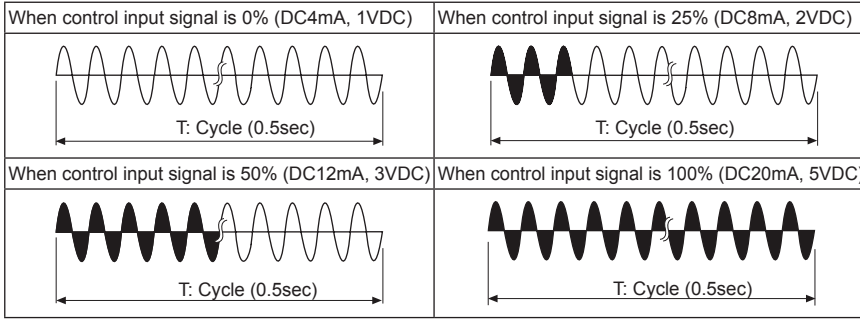

※To change control cycle, please change JP1 and JP2 of PCB as below.

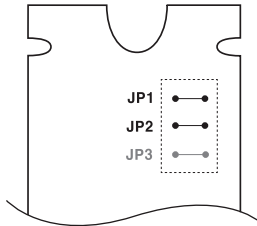

JP1	JP2	Cycle (sec)
SHORT	SHORT	0.5sec
SHORT	OPEN	2.0sec
OPEN	SHORT	10sec
OPEN	OPEN	× (not used)



### 3) ON/OFF control-Zero cross

This function is when control input is ON, output is 100%. When it is OFF, output is 0%.

It is the same function as SSR (Solid State Relay). (It always turns ON/OFF at zero point of AC.)

※OUT ADJ. and SOFT START function are not available in ON/OFF control method.

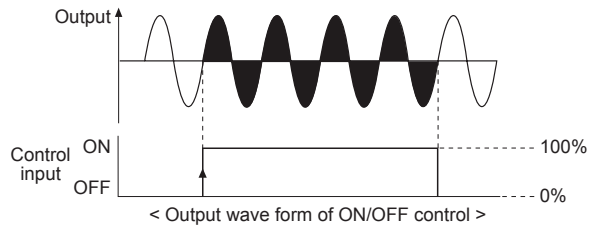

### ◎ OUT ADJ. (output limit) (0 to 100%)

This function will be [Control input (%) × OUT ADJ. (%) = Output] and it controls the power supplied into the load. Although control input is 100% (5V or 20mA), the output is the 50% which is proportioned with OUT ADJ. When not using OUT ADJ. function, please make set value 100%.

※This function must not be used in ON/OFF control method.

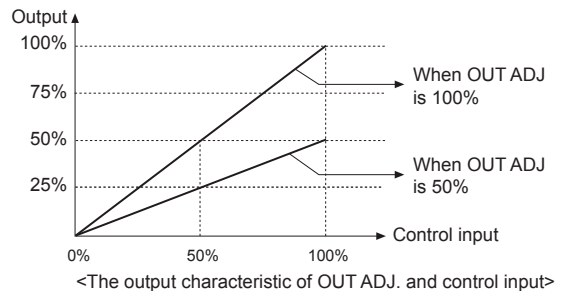

### ◎ SOFT START (0 to 50 sec)

This function protects the load in cases that the set temperature is high, such as controlling the load (platinum, molybdenum, tungsten, infrared lamp, etc.) in which inrush current flows when power is supplied, or showing large width of temperature rise during initial operation. SOFT START set time (T) is the required time that output reaches to 100%, and it is differentiated by OUT ADJ. set value. For example, SOFT START is set as 10sec and OUT ADJ. is set as 70%, it takes 7 sec to reach goal output.

[Set time (T) × OUT ADJ. set value (%) = 10 sec × 0.7 = 7 sec]  
If increasing the OUT ADJ. before output reaches to goal output, it delays as much as the value, multiply of increased value (%) and SOFT START set time. When not using SOFT START function, please make set value 0.

※This function must not be used in ON/OFF control method.

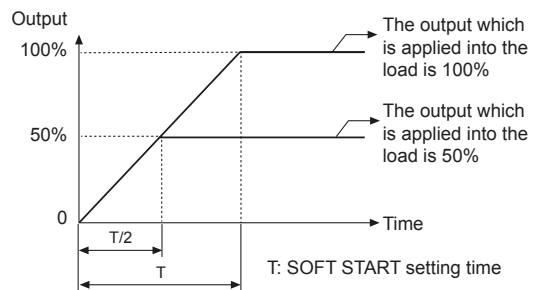

※T: Time to get the output which is applied into the load is 100%.

T/2: Time to get the output which is applied into the load is 50%.

### ◎ OUT display

This is LED lamp to display the status of output and will be getting brighter according as output.

(0%: min. LED light, 100%: max. LED light)

- (A) Photoelectric Sensors
- (B) Fiber Optic Sensors
- (C) Door/Area Sensors
- (D) Proximity Sensors
- (E) Pressure Sensors
- (F) Rotary Encoders
- (G) Connectors/ Connector Cables/ Sensor Distribution Boxes/Sockets
- (H) Temperature Controllers
- (I) SSRs / Power Controllers
- (J) Counters
- (K) Timers
- (L) Panel Meters
- (M) Tacho / Speed / Pulse Meters
- (N) Display Units
- (O) Sensor Controllers
- (P) Switching Mode Power Supplies
- (Q) Stepper Motors & Drivers & Controllers
- (R) Graphic/ Logic Panels
- (S) Field Network Devices
- (T) Software

# SPC1 Series

## ■ Applications

E.g. 1) When controlling by limiting the power at ON/OFF in phase control and cycle control method.  
For example, if it needs to control 80% output when it is ON, 24% output when it is OFF, please keep below.

Firstly set OUT ADJ. as 80% and connect external adjuster and external relay contact switch as the figure then set external adjuster as 30%.

- When the External contact signal is ON : 100% (contact input) × 80% (OUT ADJ.) = 80%
- When the External contact signal is OFF : 30% (adjuster input) × 80% (OUT ADJ.) = 24%

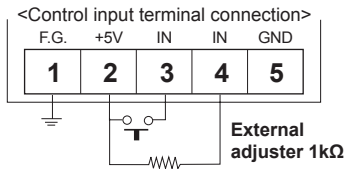

E.g. 2) This is how to control 0 to 100% without external adjuster in phase control and cycle control method.

It is possible to control 0 to 100% by turning OUT ADJ. in state of connecting terminal 2 and terminal 3.

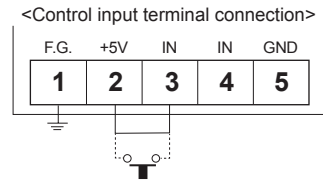

## ■ Temperature Derating Curve

### ◎ SPC1-35-E

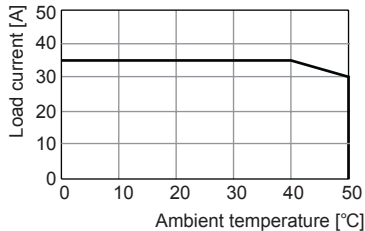

### ◎ SPC1-50-E

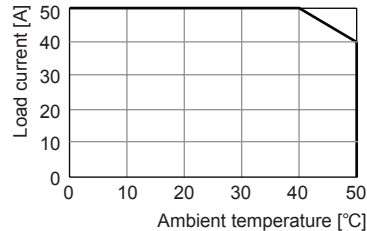

## ■ Remove of Case

After disconnecting all power sources supplied to the product, remove the case.

Push the Joint part (4 points) on the right and left side of the case with the flat head screwdriver, and disassemble the case.

**⚠ When using the tool, be careful not to injure yourself.**

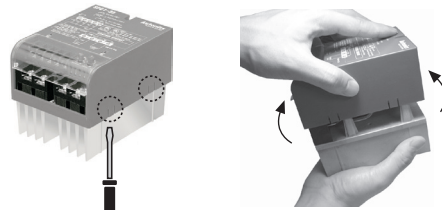

## ■ Proper Usage

### ⚠ Cautions during use

1. Follow instructions in 'Cautions during Use'. Otherwise, it may cause unexpected accidents.
2. Use the product, after 3 sec of supplying power.
3. Before use, set the mode and function according to the specification.  
Especially, be cautious that the product does not operate when OUT ADJ. is set to 0%.  
Since mode/parameter can not be changed during operation, set the mode and function after turning off the power.
4. To ensure the reliability of the product, install the product on the panel or metal surface vertically to the ground.
5. Install the unit in the well ventilated place.
6. While supplying power to the load or right after turning off the power of the load, do not touch the body and heat sink.  
Failure to follow this instruction may result in a burn due to the high temperature.
7. Install a power switch or circuit breaker in the easily accessible place for supplying or disconnecting the power.
8. Do not wire to terminals which are not used.
9. The rapid fuse must be connected between R terminal and the power source.
10. Do not use near the equipment which generates strong magnetic force or high frequency noise.
11. This unit may be used in the following environments.
  - ① Indoors (in the environment condition rated in 'Specifications')
  - ② Altitude max. 2,000m
  - ③ Pollution degree 2
  - ④ Installation category III