

SRPH1 Series

Single-Phase, Analog Input Type SSR

■ Features

- Phase control and cycle control possible with 4-20 mA analog input
 - Phase control (output power control / phase angle control)
 - Cycle control (fixed cycle / variable cycle)
- DIN rail mount or panel mount installation
- Dielectric strength: 4000 VAC
- High heat dissipation efficiency with ceramic PCB and integrated heatsink
- Zero cross turn-on, random turn-on models available
- Input indicator (green LED)



⚠ Please read "Safety considerations" in operation manual before using.



■ Ordering Information

SRP H 1 - A 2 30

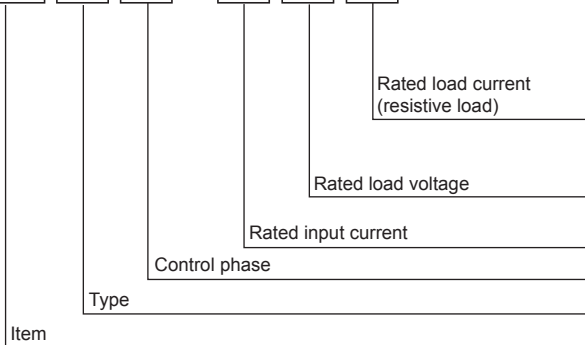

Rated load current (resistive load)	20	20A
	30	30A
	60	60A
Rated load voltage	2	100-240VAC
	4	200-480VAC
Rated input current	A	4-20mA analog input
Control phase	1	Single-phase
Type	H	Integrated heatsink type
Item	SRP	Solid State Relay (analog input type)

Model	Rated load current	Rated load voltage
SRPH1-A220	20A	100-240VAC
SRPH1-A230	30A	
SRPH1-A260	60A	

Model	Rated load current	Rated load voltage
SRPH1-A420	20A	200-480VAC
SRPH1-A430	30A	
SRPH1-A460	60A	

Single-Phase, Analog Input Type SSR

■ Specifications

○ Input

Rated input current	4-20mA
Max. allowable input current	50mA
Pick-up current	Min. 4.2mA
Static off current	Max. 0.2mA
Power factor	Min. 0.9 (max. 25° of difference between voltage phase and current phase)
Start-up time	60Hz: 200ms, 50Hz: 250ms
Operation time	60Hz: 16.6ms, 50Hz:20ms
Operation mode ^{*1}	Phase control (phase equality division type, power equality division type) Cycle control (fixed cycle, variable cycle)

※1: You can change operation mode by jumper pin. Default is Phase control (Power equality division type).

○ Output

Rated load voltage range	100-240VACrms~ (50/60Hz)			200-480VACrms~ (50/60Hz)		
Allowable load voltage range	90-264VACrms~ (50/60Hz)			200-528VACrms~ (50/60Hz)		
Rated load current	Resistive load (AC-51) ^{*1}					
	20Arms	30Arms	60Arms	20Arms	30Arms	60Arms
Min. load current	0.5Arms			0.5Arms		
Max. 1 cycle surge current (60Hz)	300A	500A	1000A	300A	500A	1000A
Max. non-repetitive surge current (I ² t, t=8.3ms)	350A ² s	1000A ² s	4000A ² s	350A ² s	1000A ² s	4000A ² s
Peak voltage (non-repetitive)	600V			1000V		
Leakage current (Ta=25°C)	Max. 10mArms (240VAC~/60Hz)			Max. 10mArms (480VAC~/60Hz)		
Output on voltage drop[Vpk] (Max. load current)	Max. 1.6V					
Static off-state dv/dt	500V/μs					

※1: AC-51 are utilization category at IEC 60947-4-3.

○ General Specifications

Phase control (phase equality division type)	5 to 99%	
Phase control (power equality division type)	10 to 99%	
Frequency reading function	Yes	
Dielectric strength (Vrms)	4000VAC~ 50/60Hz for 1min. (Input-Output, Input/Output-Case)	
Insulation resistance	Over 100MΩ (at 500VDC megger)	
Vibration	10 to 55Hz double amplitude 0.75mm in each X, Y, Z direction for 1 hour	
Indicator	Input indicator: Green LED	
Environment	Ambient temp.	-20 to 70°C, storage: -20 to 100°C (The rated load current capacity is different depending on ambient temperature. Refer to '■ SSR Derating Curve'.)
	Ambient humi.	45 to 85%RH, storage: 45 to 85%RH
Input terminal connection	Min. 1×0.5mm ² (1×AWG20) Max. 1×1.5mm ² (1×AWG6) or Max. 2×1.5mm ² (2×AWG16)	
Output terminal connection	Min. 1×1.5mm ² (1×AWG16) Max. 1×16mm ² (1×AWG6) or Max. 2×6mm ² (2×AWG10) ※Connect appropriate cable for the load current capacity to output terminal.	
Input terminal fixed torque	0.75 to 0.95N·m	
Output terminal fixed torque	1.6 to 2.2N·m	
Approval		
Unit weight	• SRPH1-A220, SRPH1-A230, SRPH1-A420, SRPH1-A430 : Approx. 410g • SRPH1-A260, SRPH1-A460 : Approx. 680g	

※Environment resistance is rated at no freezing or condensation.

※For wiring the terminal, an O-ring terminal must be used.

(A) Photoelectric Sensors

(B) Fiber Optic Sensors

(C) Door/Area Sensors

(D) Proximity Sensors

(E) Pressure Sensors

(F) Rotary Encoders

(G) Connectors/ Connector Cables/ Sensor Distribution Boxes/Sockets

(H) Temperature Controllers

(I) SSRs / Power Controllers

(J) Counters

(K) Timers

(L) Panel Meters

(M) Tacho / Speed / Pulse Meters

(N) Display Units

(O) Sensor Controllers

(P) Switching Mode Power Supplies

(Q) Stepper Motors & Drivers & Controllers

(R) Graphic/ Logic Panels

(S) Field Network Devices

(T) Software

SRPH1 Series

■ Dimensions & Mounting

(unit: mm)

○ Dimensions

- Rated load current 20A/30A

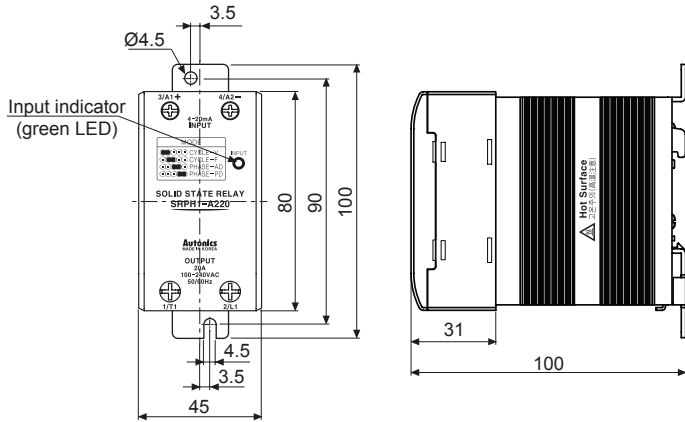

- Rated load current 60A

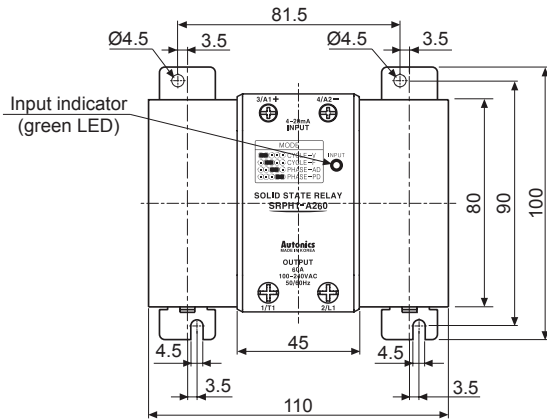

○ Hole cut-out for panel front mounting

- Rated load current 20A/30A
- Rated load current 60A

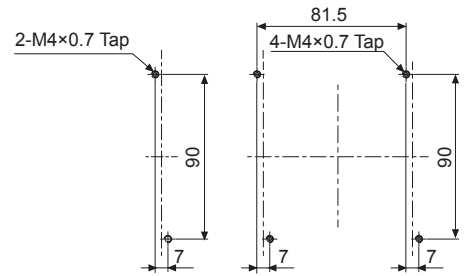

※Screw tightening torque for mounting: 1.8 to 2.5N·m

○ DIN rail mounting

- DIN rail attachment

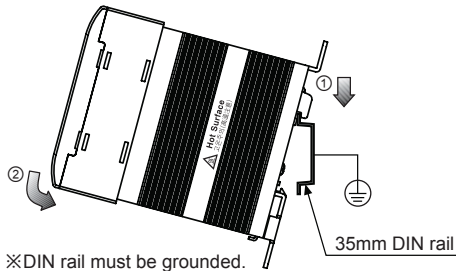

- DIN rail detachment

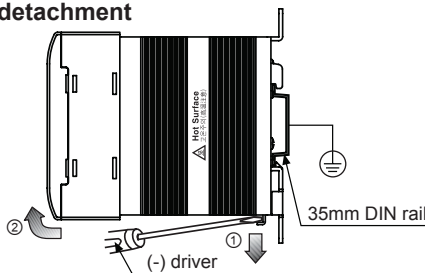

○ Installation interval

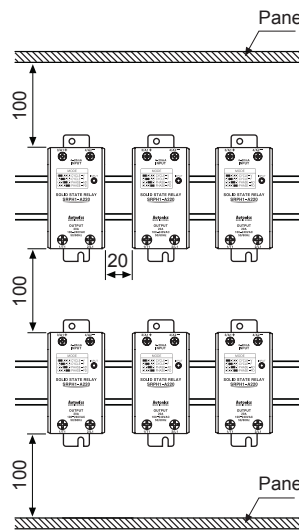

※For mounting multiple SSR, please keep certain installation intervals for heat prevention. For horizontal installation (when the heights of input part and output part are equal), it is recommended to apply 50% of rated load current.

High temperature caution
 Make sure do not touch the heat sink or the unit body while power is supplied or right after load power is turned off. If not, it may cause a burn.

Single-Phase, Analog Input Type SSR

■ Connections

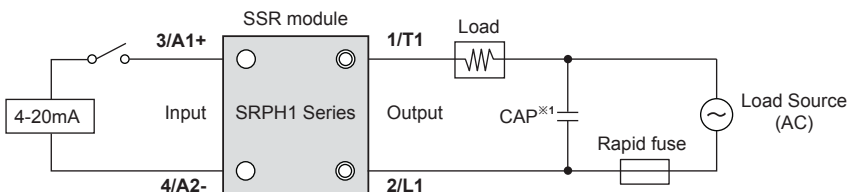

※1: As above connection, connect a capacitor. It is proper to EMC.

CAP: Load voltage 100-240VAC → 1μF/250VAC, Load voltage 200-480VAC → 0.47μF/500VAC

■ SSR Derating Curve

○ SRPH1-A220/A420

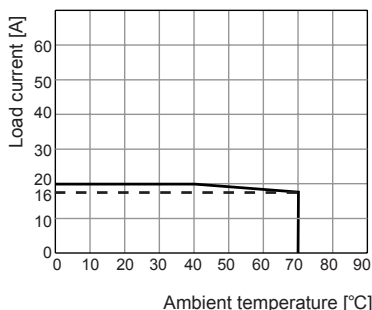

○ SRPH1-A230/A430

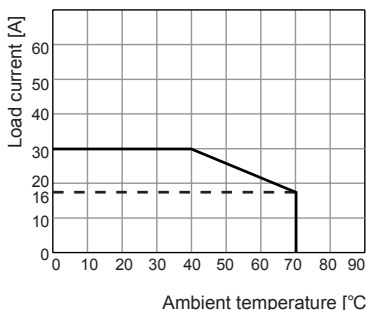

○ SRPH1-A260/A460

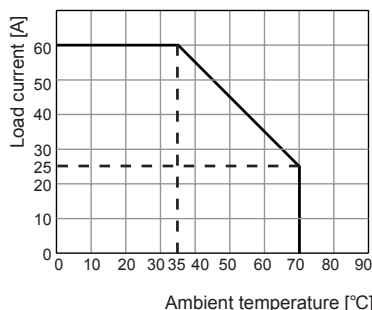

△ Please supply less than 50% of the rated load current when installing several SSRs closely due to decreasing effectiveness of protection against heat.

■ Operation Setting

● Detach front cover

Press front cover connection 4 parts at right and left side with (-) driver, and front cover is detached.

※Before detaching front cover, you must cut off load current and input.

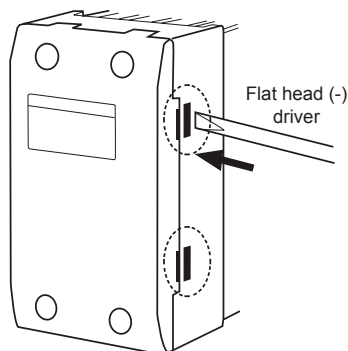

● Jumper pin setting

Operation mode is decided by jumper position. After changing operation mode, re-supply input signal.

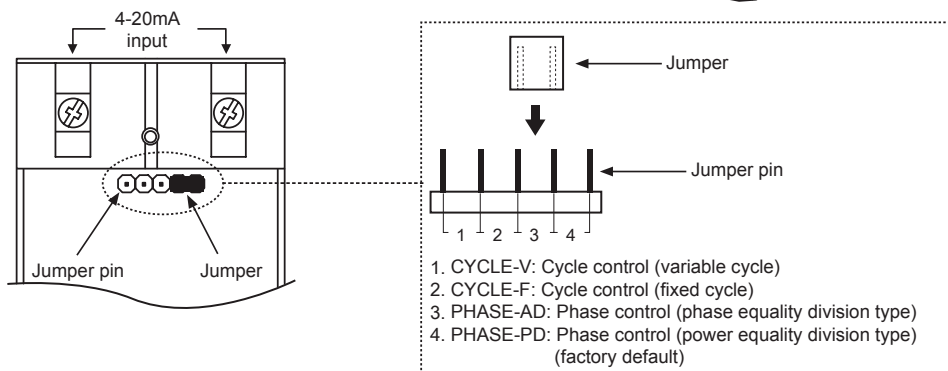

(A)	Photoelectric Sensors
(B)	Fiber Optic Sensors
(C)	Door/Area Sensors
(D)	Proximity Sensors
(E)	Pressure Sensors
(F)	Rotary Encoders
(G)	Connectors/ Connector Cables/ Sensor Distribution Boxes/Sockets
(H)	Temperature Controllers
(I)	SSRs / Power Controllers
(J)	Counters
(K)	Timers
(L)	Panel Meters
(M)	Tacho / Speed / Pulse Meters
(N)	Display Units
(O)	Sensor Controllers
(P)	Switching Mode Power Supplies
(Q)	Stepper Motors & Drivers & Controllers
(R)	Graphic/ Logic Panels
(S)	Field Network Devices
(T)	Software

SRPH1 Series

■ Operation Mode

○ Phase control

● Output waveform of phase control

- When control input signal is 25%
- When control input signal is 50%
- When control input signal is 75%

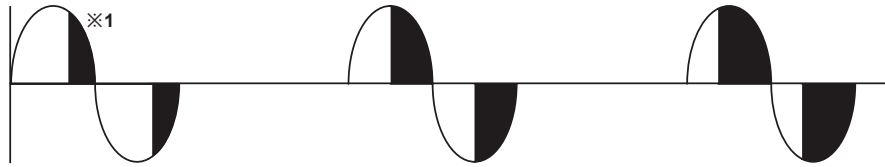

※1: The black parts of output waveform are output on the load.

● Power equality division type

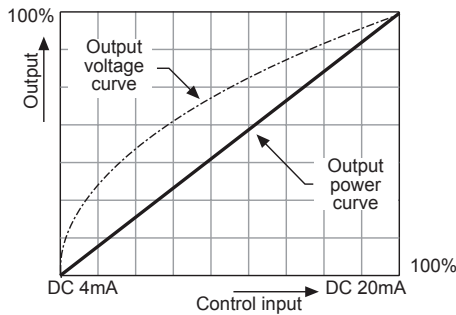

Controls output power which is proportional to control input (4-20mA) level.

● Phase equality division type

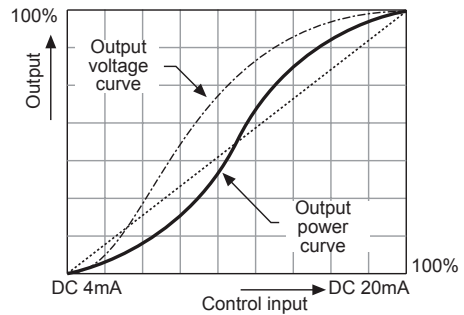

Controls phase angle which is proportional control input (4-20mA) level.

○ Cycle control

● Fixed cycle

Controls continuously the number of full cycle which is supplied to load every 1 sec by being proportional to control input (4-20mA).

- When control input signal is 0%

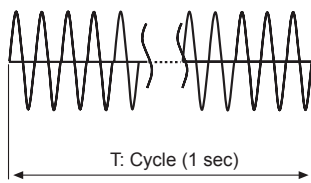

- When control input signal is 50%

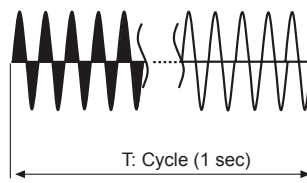

- When control input signal is 100%

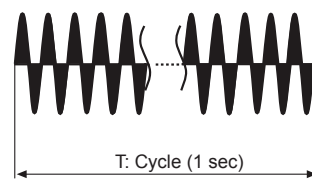

● Variable cycle

Controls fast and accurately the subject with optimized the number of AC voltage cycle which is supplied to load by being proportional to control input (4-20mA).

- When control input signal is 10%

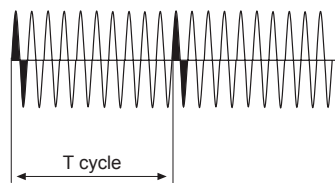

- When control input signal is 50%

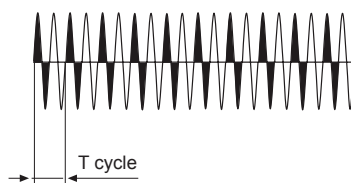

- When control input signal is 90%

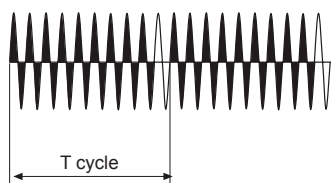

Single-Phase, Analog Input Type SSR

■ Proper Usage



High temperature caution

Make sure do not touch the heat sink or the unit body while power is supplied or right after load power is turned off. If not, it may cause a burn.



Cautions during use

1. Ventilate for smooth convection current. If not, congested heat transfer may cause product failure or malfunction.
2. Must ground heatsink or mounted DIN rail. Failure to follow this instruction may cause electric shock.
3. For mounting multiple SSR, please keep certain installation intervals for heat prevention. For horizontal installation (when the heights of input part and output part are equal), it is recommended to apply less than 50% of the rated load current.
4. Make sure do not touch the heatsink or the unit body while power is supplied or right after load power is turned OFF. If not, it may cause a burn.
5. Connect the proper cable for the rated load current with output terminal.
6. Use rapid fuse of which I^2t is under 1/2 of SSR I^2t in order to protect the unit from load's short-circuit current. In case of a short-circuit please replace the fuse which has same specification.
7. In case that load's current is lower than SSR min. load current, connect dummy resistance to the load in parallel so as to make load's current higher than SSR min. load current.
8. Make sure that the screw on output terminal is tightly fastened. Using the unit with loose bolt may cause product failure or malfunction.
9. Do not touch the load's terminal even if output is OFF. It may cause electric shock.
10. The input of the 4-20mA should be supplied by the insulated and limited voltage/current or by class 2 power supply.
11. Avoid following environments to install this unit.
 - ① Where temperature/humidity is beyond the specification
 - ② Where dew condensation occurs due to temperature change
 - ③ Where inflammable or corrosive gas exists
 - ④ Where direct rays of light exist
 - ⑤ Where severe shock, vibration or dust exists
 - ⑥ Where near facilities generating strong magnetic forces or electric noise
12. This product may be used in the following environments.
 - ① Indoors
 - ② Max. altitude: 2,000m
 - ③ Pollution degree 2
 - ④ Installation category III

(A)
Photoelectric
Sensors

(B)
Fiber
Optic
Sensors

(C)
Door/Area
Sensors

(D)
Proximity
Sensors

(E)
Pressure
Sensors

(F)
Rotary
Encoders

(G)
Connectors/
Connector Cables/
Sensor Distribution
Boxes/Sockets

(H)
Temperature
Controllers

(I)
SSRs / Power
Controllers

(J)
Counters

(K)
Timers

(L)
Panel
Meters

(M)
Tacho /
Speed / Pulse
Meters

(N)
Display
Units

(O)
Sensor
Controllers

(P)
Switching
Mode Power
Supplies

(Q)
Stepper Motors
& Drivers
& Controllers

(R)
Graphic/
Logic
Panels

(S)
Field
Network
Devices

(T)
Software