

Refrigeration Temperature Controller

■ Features

- ON/OFF Control
- Input specification - Basic specification: NTC (Thermistor), Option: RTD (DPt100Ω)
- Temperature display range
 NTC sensor type: -40.0 to 99.9°C (-40 to 212°F)
 RTD sensor type: -99.9 to 99.9°C (-148 to 212°F)
- Supports various delay functions for utilize freezing
 Auto/Manual Defrost selection function, Start-up delay of compressor, Restart delay time, Minimum ON time, Defrost end delay, Operation delay of evaporation-fan
- Input correction function
- Enable to set operation period for protecting compressor in error.



⚠ Please read "Safety considerations" in operation manual before using.



■ Ordering Information

TC 3 Y F - 1 4 R

Item	TC	3	Y	F	-	1	4	R	
Digit		3	Y	F					
Size				F					
Control mode					-				
Control output for refrigeration						1			1 Compressor output
Power supply							4		4 100-240VAC 50/60Hz
Control output								R	R Relay output
Item									
									1 12-24VDC
									2 Compressor+Defrost output
									3 Compressor+Defrost+Evaporation-fan output
									F Freezing
									Y DIN W72×H36mm
									3 999 (3-digit)
									TC Temperature Controller

■ Specifications

Model		TC3YF-1□R	TC3YF-2□R	TC3YF-3□R
Power supply	AC power	100-240VAC~ 50/60Hz		
	DC power	12-24VDC=		
Allowable voltage range		90 to 110% of rated voltage		
Power consumption	AC power	Max. 4VA (100-240VAC 50/60Hz)		
	DC power	Max. 8W (12-24VDC)		
Display method		7 Segment LED method (red)		
Character size (W×H)		7.4×15.0mm		
Input type		NTC: 5kΩ, RTD*: DPt 100Ω		
Input line resistance		Allowable line resistance is max. 5Ω per a wire		
Sampling period		500ms		
Display accuracy		• At room temp. (23 ±5°C): (PV ±0.5% or 1°C, select the higher one) rdg ±1digit • Out of room temp. range: (PV ±0.5% or 1°C, select the higher one) rdg ±1°C		
Control output	Compressor (COMP)	250VAC~ 5A 1a		
	Defrost (DEF)	—	250VAC~ 10A 1a	
	Evaporator-fan (FAN)	—	—	250VAC~ 5A 1a
Control method		ON/OFF control		
Hysteresis		0.5 to 5.0°C, 2 to 50°F variable		
Relay life cycle	Compressor (COMP)	Mechanical: Min. 20,000,000 operations, Electrical: Min. 50,000 operations (250VAC 5A resistive load)		
	Defrost (DEF)	Mechanical: Min. 20,000,000 operations, Electrical: Min. 100,000 operations (250VAC 10A resistive load)		
	Evaporator-fan (FAN)	Mechanical: Min. 20,000,000 operations, Electrical: Min. 50,000 operations (250VAC 5A resistive load)		
Memory retention		Approx. 10 years (non-volatile memory method)		
Insulation resistance		100MΩ (at 500VDC megger)		
Dielectric strength		2000VAC 60Hz for 1 min (between all external terminals and case)		
Vibration	Mechanical	0.75mm amplitude at frequency of 10 to 55Hz (for 1 min) in each X, Y, Z direction for 2 hours		
	Malfunction	0.5mm amplitude at frequency of 10 to 55Hz (for 1 min) in each X, Y, Z direction for 10 min		
Noise immunity	AC power	Square-wave noise by the noise simulator (pulse width: 1μs) ±2kV R-phase and S-phase		
	DC power	Square-wave noise by the noise simulator (pulse width: 1μs) ±500V R-phase and S-phase		
Environment	Ambient temperature	-10 to 50°C, storage: -20 to 60°C		
	Ambient humidity	35 to 85%RH, storage: 35 to 85%RH		
Protection structure		IP65 (front part, IEC Standards)		
Approval	AC power	cULus (except RTD option models)		
	DC power	—		
Weight*2		Approx. 229g (approx. 143g)		

※1: RTD input type is option.

※2: The weight includes packaging. The weight in parenthesis is for unit only. The weight may be varied by model specification and option.

※Environment resistance is rated at no freezing or condensation.

Connections

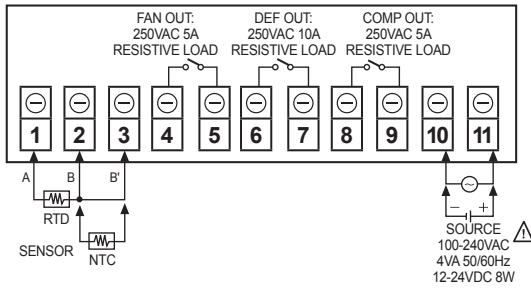

※ Use crimp terminals of size specified below. (unit: mm)

 <Crimp terminal>	Terminal number	a	b	c
	1 to Nmm	6mm	Max. 1.9	Max. 4.0

Installation

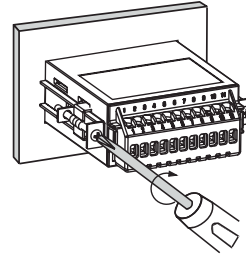

※ Insert this unit into a panel, fasten bracket by pushing with tools as shown.

Dimensions

(unit: mm)

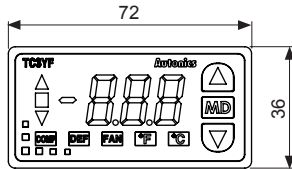

Panel cut-out

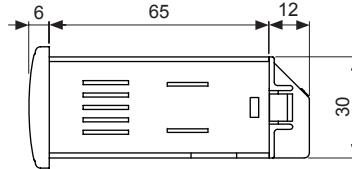
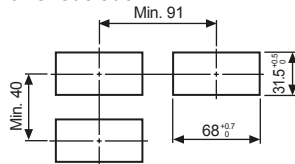

Bracket

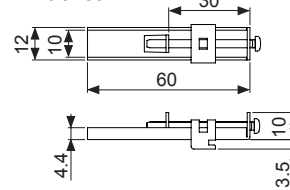

Unit Description

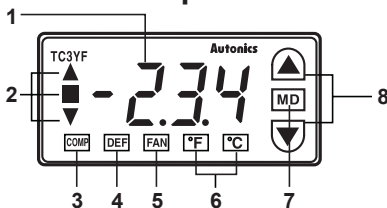

- Measured value (PV) display component (red):**
RUN mode: Displays currently measured value (PV).
Setting mode: Displays parameter and setting value.
- Deviation indicator [▲, ▼] (red) / (green):**
Displays deviation of present value (PV) based on setting value (SV).
- Compressor (COMP) output indicator:**
Turns ON for compressor output. Flashes for protection operation, not compressor output.

- Defrost (DEF) output indicator:** Turns ON for defrost output. Flashes for defrost delay operation.
- Evaporator-fan (FAN) output indicator:** Turns ON for Evaporator-fan output. Flashes for delay operation of Evaporator-fan output.
- Unit indicator (°C, °F):** Displays temperature unit
- [MD] key:** Used for entering parameter setting group, returning RUN mode, moving parameter or saving SV.
- [▲, ▼] key:** Used for changing SV of parameter setting.

Hold the [▲] key for 3 sec in RUN mode to execute/stop manual defrost.

Input Type and Range

※ 1: RTD input type is option.

Input sensor	Temperature range (°C)	Temperature range (°F)
Thermistor (5kΩ)	-40.0 to 99.9	-40 to 212
RTD (DPT100Ω)	-99.9 to 99.9	-148 to 212

SV Setting

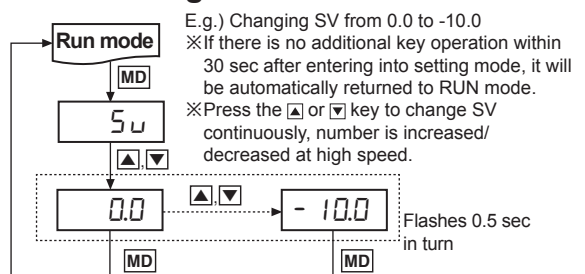

(A) Photoelectric Sensors

(B) Fiber Optic Sensors

(C) Door/Area Sensors

(D) Proximity Sensors

(E) Pressure Sensors

(F) Rotary Encoders

(G) Connectors/ Connector Cables/ Sensor Distribution Boxes/Sockets

(H) Temperature Controllers

(I) SSRs / Power Controllers

(J) Counters

(K) Timers

(L) Panel Meters

(M) Tacho / Speed / Pulse Meters

(N) Display Units

(O) Sensor Controllers

(P) Switching Mode Power Supplies

(Q) Stepper Motors & Drivers & Controllers

(R) Graphic/ Logic Panels

(S) Field Network Devices

(T) Software

Parameter 1 Group

※Press the **[MD]** key after checking/changing each parameter to save the SV and it moves to the next parameter.
 ※Hold the **[MD]** key for 3 sec while in setting mode to return RUN mode.

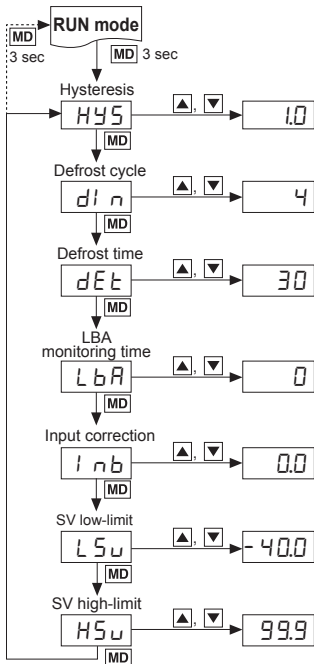

Setting range: 0.5 to 5.0°C, 2 to 50°F

Setting range: 0 to 24 hour
 ※Setting as [0], only manual defrost is available.

Setting range: 0 to 59 min
 ※Setting as [0], defrost output does not operate.

Setting range: 0 to 999 sec
 ※Setting as [0], LBA function does not operate.

Setting range: -10.0 to 10.0°C, -18 to 18°F

Setting range: Refer to 'Input Type and Temperature Range'.

Parameter 2 Group

※Press the **[MD]** key after checking/changing each parameter to save the SV and it moves to the next parameter.
 ※Hold the **[MD]** key for 3 sec while in setting mode to return RUN mode.
 ※.....: The dot line parameter may not be displayed by other parameter setting.

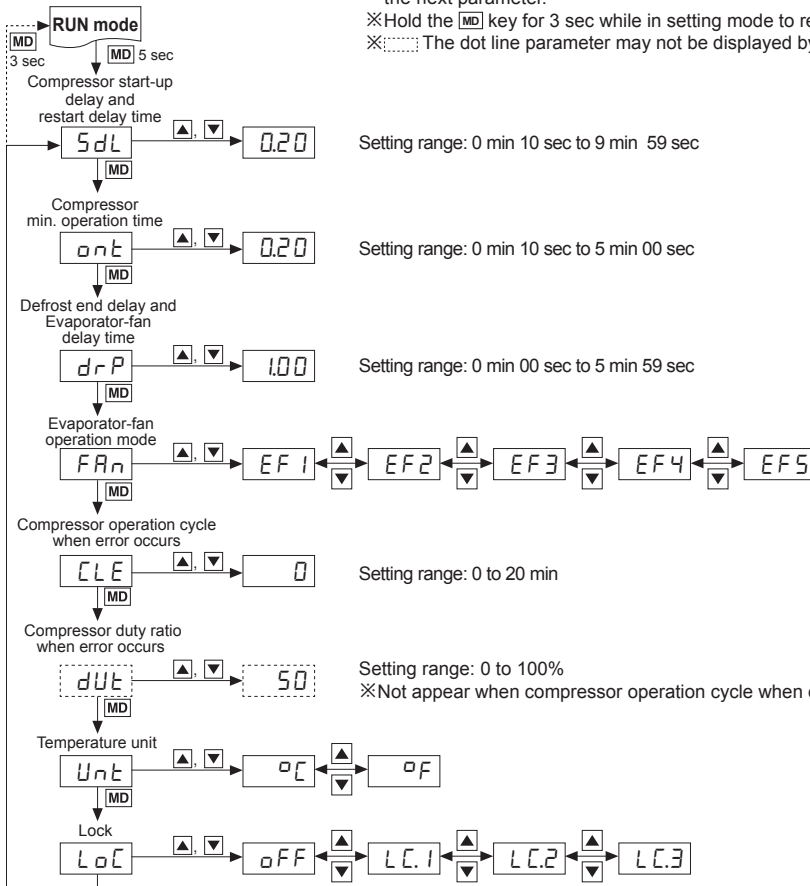

Setting range: 0 min 10 sec to 9 min 59 sec

Setting range: 0 min 10 sec to 5 min 00 sec

Setting range: 0 min 00 sec to 5 min 59 sec

Setting range: 0 to 20 min

Setting range: 0 to 100%
 ※Not appear when compressor operation cycle when error occurs [CLE] is set as [0].

■ Factory Default

● SV Setting

Parameter	Default
<i>Sv</i>	0.0

● Parameter 1 group

Parameter	Default	Parameter	Default
<i>HYS</i>	1.0	<i>lnb</i>	0.0
<i>dln</i>	4	<i>LSu</i>	40.0
<i>dEt</i>	30	<i>HSu</i>	9 9.9
<i>LbR</i>	0		

● Parameter 2 group

Parameter	Default	Parameter	Default
<i>SdL</i>	0.20	<i>CLL</i>	0
<i>oNt</i>	0.20	<i>dUt</i>	50
<i>drP</i>	1.00	<i>UnL</i>	°C
<i>FRn</i>	EFF	<i>LoC</i>	oFF

■ Function

◎ Compressor Protection

This function is for preventing compressor from life cycle shortening or malfunction by overload and frequent ON/OFF of compressor. As compressor protection settings, when compressor output does not ON, the front compressor (COMP) output indicator is flashing.

● Compressor start-up delay and restart delay time [*SdL*]

If power turns ON instantly from break-down or power OFF, it delays start-up during the set time of compressor. To prevent frequent compressor ON/OFF, set compressor ON time after compressor turns OFF.

Setting range: 0 min 10 sec to 9 min 59 sec

● Compressor min. operation time [*oNt*]

To prevent frequent compressor ON/OFF, set min. operation time. Setting range: 0 min 10 sec to 5 min 00 sec

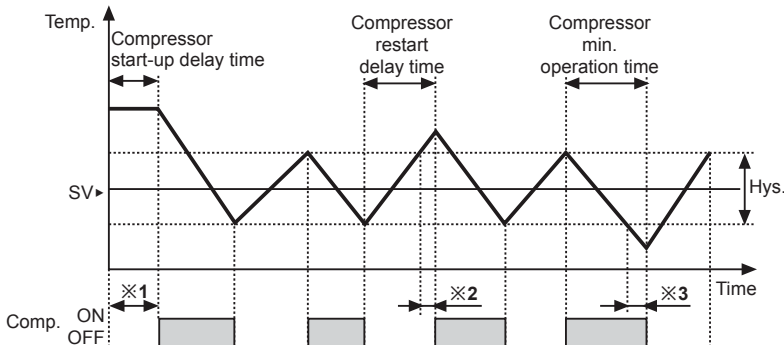

※1. When starting compressor, if present value (PV) is out of hysteresis range, compressor output does not turn ON and the compressor (COMP) output indicator is flashing during compressor start-up delay time.

※2. When present value (PV) is out of hysteresis, compressor output does not turn ON and the compressor (COMP) output indicator is flashing during compressor restart delay time.

※3. If present value (PV) is below the SV, compressor output maintains ON status during compressor min. operation time. After compressor min. operation time, it turns OFF.

◎ Compressor Control When Error Occur

If normal temperature control is impossible due to error, it controls compressor output by the set operation cycle and duty ratio to protect control object. Until error is cleared, operation cycle and duty ratio are applied repeatedly.

● Compressor operation cycle [*CLL*], duty ratio [*dUt*] when error occur

Set Compressor operation cycle and ON duty ration when error occur.

Set operation cycle as [0], and compressor output turns OFF.

Set duty ratio as [100], and compressor output turns ON continuously.

Setting range of compressor operation cycle when error occur: 0 to 20 min

Setting range of compressor duty ratio when error occur: 0 to 100%

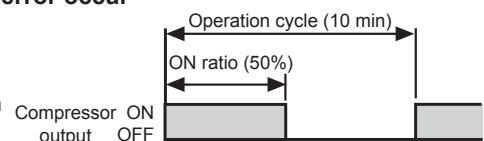

E.g.) When compressor operation cycle when error occur [*CLL*] is set as 10 min and compressor duty ratio when error occur [*dUt*] is set as 50%, compressor output has 10 min cycle and turns ON for 5 min and turns OFF for 5 min.

(A) Photoelectric Sensors

(B) Fiber Optic Sensors

(C) Door/Area Sensors

(D) Proximity Sensors

(E) Pressure Sensors

(F) Rotary Encoders

(G) Connectors/ Connector Cables/ Sensor Distribution Boxes/Sockets

(H) Temperature Controllers

(I) SSRs / Power Controllers

(J) Counters

(K) Timers

(L) Panel Meters

(M) Tacho / Speed / Pulse Meters

(N) Display Units

(O) Sensor Controllers

(P) Switching Mode Power Supplies

(Q) Stepper Motors & Drivers & Controllers

(R) Graphic/ Logic Panels

(S) Field Network Devices

(T) Software

◎ Defrost Control

When operating a compressor for a long time, an evaporator and a freezer are freezing and thermal efficiency of compressor is decreased. For increasing thermal efficiency, defrost operation helps to remove frost or ice around of evaporator.

Set defrost cycle, time, etc. to operate defrost (heater defrost).

The front defrost (DEF) output indicator turns ON during defrost output and it flashes during defrost delay operation.

● Defrost cycle [dFn], Defrost time [dEt]

Set defrost cycle and time to operate defrost at every set cycle and during the set time.

Set defrost cycle as [D], only manual defrost is available.

Setting range of defrost cycle: 0 to 24 hour Defrost time Setting range: 0 to 59 min

● Manual defrost

Execute defrost manually regardless of the set defrost cycle. Hold the \square key for 3 sec to operate defrost during the set defrost time. When defrost output turns ON, operating compressor output, Evaporator-fan output turn OFF. Hold the \square key for 3 sec during manual defrost, applied manual defrost is complete and pre-set defrost cycle restarts.

● Defrost end delay and Evaporator-fan start-up delay time [drP]

Defrost end delay time and Evaporator-fan start-up delay time operate individually by one setting.

Setting range: 0 min 00 sec to 5 min 59 sec

- Defrost end delay time: During defrost operation, drops may exist at evaporator. Set the time to drain remained drops after completing defrost.
- Evaporator-fan start-up delay time: If evaporator temperature is increased by defrost operation, warm air may flow into cooling system by Evaporator-fan operation. Set Evaporator-fan start-up delay time to prevent warm air inflow, and it may increase cooling efficiency.

◎ Evaporator-fan operation mode

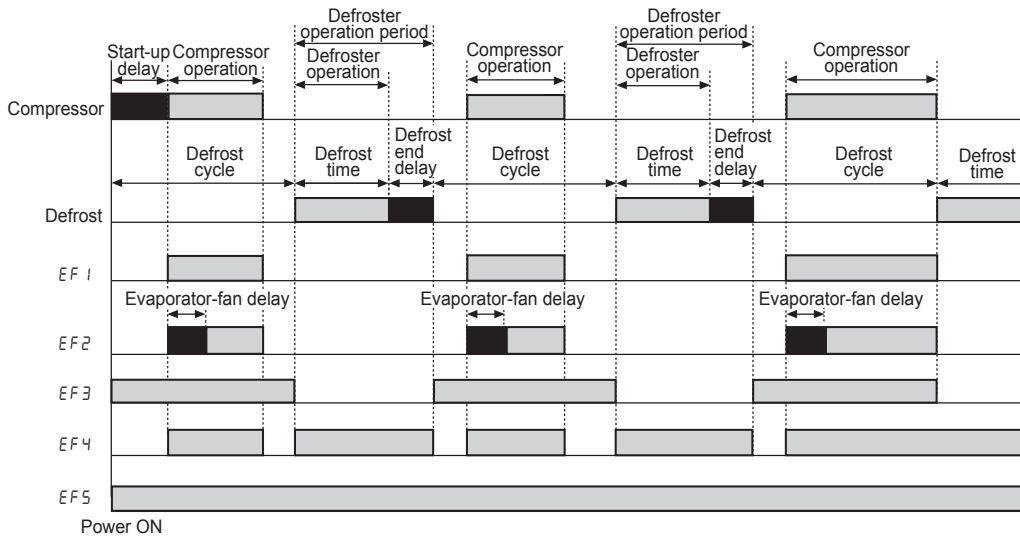

- : Output does not turn ON but the dedicated indicator flashes at the delay period (compressor, defrost, evaporator-fan).

Parameter	Operation method
EF1	When compressor operates, evaporator-fan also operates. When compressor operation is finished, evaporator-fan also operation turns OFF.
EF2	When compressor operates, evaporator-fan operates after the set evaporator-fan start-up delay time. When compressor operation is finished, evaporator-fan operation turns OFF. (regardless of defroster operation)
EF3	When power turns ON, evaporator-fan operates. When defroster operates, evaporator-fan stops. (regardless of compressor operation)
EF4	Evaporator-fan operates only when operating compressor or defrost. Evaporator-fan stops when compressor and defroster stops. (for above zero temperature control)
EF5	Evaporator-fan operates from power ON to power OFF. (regardless of compressor, defroster operation)

◎ Loop Break Alarm (LBA) [L bA]

When freezer temperature is not changed over 1.0 (2°F) during set LBA monitoring time [L bA] of parameter 1 group, it regards as abnormal compressor and it displays error. (Err ↔ L bA, flashings in turn) When error occur, compressor is controlled according to the set compressor operation cycle [LE] and duty ratio [DUE] when error occur. Check the compressor and hold the [▲+▼] keys for 3 sec and error clears and it operates normally. Setting range: 0 to 999 sec (Setting as [0], LBA function does not operate)

◎ Lock

For preventing changing SV and parameters of each parameter group.

Display	Description
oFF	Unlock
LC.1	Parameter 2 group
LC.2	Locks parameter 1, 2 groups
LC.3	Locks parameter 1, 2 groups, SV setting

◎ Error Display

Flashing in turn	Description	Troubleshooting
Err ↔ oPn	When input sensor is break or sensor is disconnected.	Check input sensor status.
Err ↔ HHH	If the measured temperature is higher than high-limit temperature among temperature setting range.	It clears when input is within the display range.
Err ↔ LLL	If the measured temperature is lower than low-limit temperature among temperature setting range.	
Err ↔ L bA	Even though input sensor is normal, freezer temperature does not change over 1.0°C (2°F) during LBA monitoring time [L bA].	Check the compressor and hold the [▲+▼] key at the same time for 3 sec. It clears when input is within the adequate range.

■ Proper Usage

◎ Cautions during use

- Follow instructions in 'Cautions during use'. Otherwise, It may cause unexpected accidents.
- Check the polarity of the terminals before wiring the temperature sensor.
For RTD temperature sensor, wire it as 3-wire type, using cables in same thickness and length.
For thermocouple (CT) temperature sensor, use the designated compensation wire for extending wire.
- Keep away from high voltage lines or power lines to prevent inductive noise.
In case installing power line and input signal line closely, use line filter or varistor at power line and shielded wire at input signal line.
Do not use near the equipment which generates strong magnetic force or high frequency noise.
- Install a power switch or circuit breaker in the easily accessible place for supplying or disconnecting the power.
- Do not use the unit for other purpose (e.g. voltmeter, ammeter), but temperature controller.
- 12-24VDC power supply should be insulated and limited voltage/current or Class 2, SELV power supply device.
- Make a required space around the unit for radiation of heat.
For accurate temperature measurement, warm up the unit over 20 min after turning on the power.
- Install a surge absorber at each end of inductive load coil when controlling high-capacity power relay or inductive load (e.g. magnet).
- Make sure that power supply voltage reaches to the rated voltage within 2 sec after supplying power.
- Do not wire to terminals which are not used.
- This unit may be used in the following environments.
 - Indoors
(in the environment condition rated in 'Specifications')
 - Altitude max. 2,000m
 - Pollution degree 2
 - Installation category II

(A) Photoelectric Sensors

(B) Fiber Optic Sensors

(C) Door/Area Sensors

(D) Proximity Sensors

(E) Pressure Sensors

(F) Rotary Encoders

(G) Connectors/ Connector Cables/ Sensor Distribution Boxes/Sockets

(H) Temperature Controllers

(I) SSRs / Power Controllers

(J) Counters

(K) Timers

(L) Panel Meters

(M) Tacho / Speed / Pulse Meters

(N) Display Units

(O) Sensor Controllers

(P) Switching Mode Power Supplies

(Q) Stepper Motors & Drivers & Controllers

(R) Graphic/ Logic Panels

(S) Field Network Devices

(T) Software