

Autonics

LCD Display PID Temperature Controller TX4S SERIES

INSTRUCTION MANUAL



Thank you for choosing our Autonics product.
Please read the following safety considerations before use.

■ Safety Considerations

- ※ Please observe all safety considerations for safe and proper product operation to avoid hazards.
- ※ Safety considerations are categorized as follows.
 - Warning** Failure to follow these instructions may result in serious injury or death.
 - Caution** Failure to follow these instructions may result in personal injury or product damage.
- ※ The symbols used on the product and instruction manual represent the following
 - ▲ symbol represents caution due to special circumstances in which hazards may occur.

▲ Warning

- Fail-safe device must be installed when using the unit with machinery that may cause serious injury or substantial economic loss.** (e.g. nuclear power control, medical equipment, ships, vehicles, railways, aircraft, combustion apparatus, safety equipment, crime/disaster prevention devices, etc.) Failure to follow this instruction may result in fire, personal injury, or economic loss.
- Install on a device panel to use.** Failure to follow this instruction may result in electric shock or fire.
- Do not connect, repair, or inspect the unit while connected to a power source.** Failure to follow this instruction may result in electric shock or fire.
- Check 'Connections' before wiring.** Failure to follow this instruction may result in fire.
- Do not disassemble or modify the unit.** Failure to follow this instruction may result in electric shock or fire.

▲ Caution

- When connecting the power input and relay output, use AWG 20(0.50mm²) cable or over and tighten the terminal screw with a tightening torque of 0.74-0.90N·m.** When connecting the sensor input and communication cable without dedicated cable, use AWG 28-16 cable and tighten the terminal screw with a tightening torque of 0.74-0.90N·m. Failure to follow this instruction may result in fire or malfunction due to contact failure.
- Use the unit within the rated specifications.** Failure to follow this instruction may result in fire or product damage.
- Use dry cloth to clean the unit, and do not use water or organic solvent.** Failure to follow this instruction may result in electric shock or fire.
- Do not use the unit in the place where flammable/explosive/corrosive gas, humidity, direct sunlight, radiant heat, vibration, impact, or salinity may be present.** Failure to follow this instruction may result in fire or explosion.
- Keep metal chip, dust, and wire residue from flowing into the unit.** Failure to follow this instruction may result in fire or product damage.

■ Ordering Information

TX	4	S	-	1	4	R								
Control output	R	Relay output	Power supply	4	100-240VAC 50/60Hz	Option output	1	Alarm output 1	2	Alarm output 1+Alarm output 2	A	Alarm output 1+Alarm output 2+Trans. output	B	Alarm output 1+Alarm output 2+RS485 com. output
Size	S	DIN W48×H48mm	Digit	4	9999(4 digit)	Item	TX	LCD display standard PID temperature controller						

■ Installation

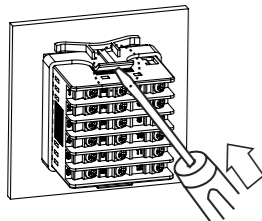

Mount the unit on the panel. Push the bracket with tools to fix the unit as the figure.

- ※ The above specifications are subject to change and some models may be discontinued without notice.
- ※ Be sure to follow cautions written in the instruction manual and the technical descriptions (catalog, homepage).

■ Specifications

Series	TX4S
Power supply	100-240VAC ~ 50/60Hz
Allowable voltage range	90 to 110% of rated voltage
Power consumption	Max. 8VA
Display method	11 segments (PV: white, SV: green), other display (yellow) with LCD method ^{※1}
Character size	PV(W×H) 6.9×15.3mm SV(W×H) 4.1×9.2mm
Input type	RTD DP1100Ω, Cu50Ω (permissible line resistance max. 5Ω) TC K(CA), J(IC), L(IC), T(CC), R(PR), S(PR)
Display accuracy ^{※2}	RTD ● At room temperature (23°C±5°C): (PV ±0.3% or ±1°C, select the higher one) ±1digit TC ● Out of room temperature: (PV ±0.5% or ±2°C, select the higher one) ±1digit
Control output	Relay 250VAC ~ 3A 1a SSR Max. 12VDC ~ 2V 20mA Current DC4-20mA or DC0-20mA (load resistance max. 500Ω)
Option output	Alarm output AL1, AL2 Relay: 250VAC ~ 3A 1a Trans. output DC4-20mA (load resistance max. 500Ω, output accuracy: ±0.3%F.S.) Com. output RS485 Communication output (Modbus RTU method)
Control method	ON/OFF control, P, PI, PD, PID control
Hysteresis	1 to 100°C/°F (0.1 to 50.0°C/°F) variable
Proportional band(P)	0.1 to 999.9°C/°F
Integral time(I)	0 to 9999 sec
Derivative time(D)	0 to 9999 sec
Control period(T)	0.5 to 120.0 sec
Manual reset	0.0 to 100.0%
Sampling period	50ms
Dielectric strength	3,000VAC 50/60Hz for 1 min (between all terminals and case)
Vibration	0.75mm amplitude at frequency 5 to 55Hz (for 1 min) in each X, Y, Z direction for 2 hours
Relay life cycle	Mechanical OUT, AL1/2: Min. 5,000,000 operations Electrical OUT, AL1/2: Min. 200,000 (250VAC 3A resistance load)
Insulation resistance	Min. 100MΩ (at 500VDC megger)
Noise resistance	Square shaped noise by noise simulator (pulse width 1μs) ±2kV R-phase, S-phase
Memory retention	Approx. 10 years (non-volatile semiconductor memory type)
Environment	Ambient temp. -10 to 50°C, storage: -20 to 60°C Ambient humi. 35 to 85%RH, storage: 35 to 85%RH
Protection structure	IP50 (front panel, IEC standards)
Insulation type	Double insulation (mark: □ dielectric strength between all terminals and case: 3kV)
Approval	CE, RoHS, US
Weight ^{※3}	Approx. 135.2g (approx. 85.2g)

- ※1: When using the unit at low temperature (below 0°C), display cycle is slow. Control output operates normally.
- ※2: ● At room temperature (23°C±5°C)
 - TC R(PR), S(PR), below 200°C: (PV ±0.5% or ±3°C, select the higher one) ±1 digit
 - TC L(IC), RTD Cu50Ω: (PV ±0.5% or ±3°C, select the higher one) ±1 digit
 - Out of room temperature range
 - TC R(PR), S(PR): (PV ±1.0% or ±5°C, select the higher one) ±1 digit
 - TC L(IC), RTD Cu50Ω: (PV ±0.5% or ±3°C, select the higher one) ±1 digit
- ※3: The weight includes packaging. The weight in parentheses is for unit only.
- ※ Environment resistance is rated at no freezing or condensation.

■ Unit Description

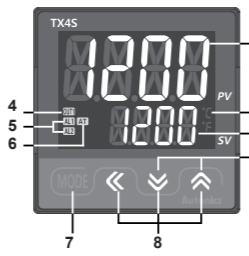

- Measured value (PV) component:** RUN mode: Displays current measured value (PV). SETTING mode: Displays parameters.
- Setting value (SV) display component:** RUN mode: Displays setting value (SV). SETTING mode: Displays setting value of parameter.
- Temperature unit(°C/°F) indicator:** Displays the set temperature unit as temperature unit [UNI L] of parameter 2 group.
- Control output (OUT1) indicator:** Turns ON while control output is ON. ※ Turns ON when MV is over 3.0% at cycle/phase control of SSR drive output method.
- Alarm output (AL1, AL2) indicator:** Turns ON when the corresponding alarm output turns ON.
- Auto-tuning indicator:** Flashes during auto-tuning every 1 sec.
- MODE key:** Enters parameter group, returns to RUN mode, moves parameters, and saves the setting value.
- Setting value adjustment key:** Enters SV setting mode and move digits.
- Digital input key:** Press the [MODE] key for 3 sec to execute the digital input key functions which is set at digital input key [dI - I] of parameter 2 group (RUN/STOP, clear alarm output, auto-tuning).
- PC loader port:** It is for serial communication to set parameter and monitoring by DAQMaster installed in PC. Use this for connection EXT-US (converter cable, sold separately) + SCM-US (USB to Serial converter, sold separately).

■ Connection

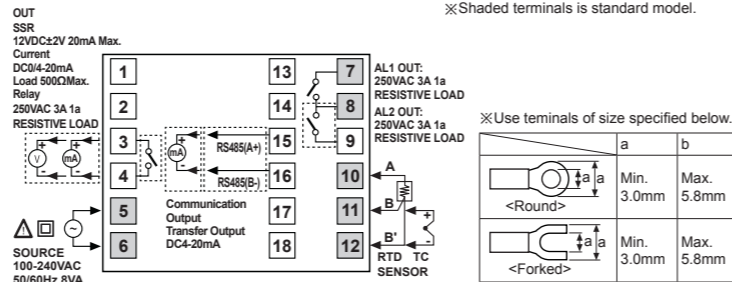

■ Input Type And Range

Input type	Decimal point	Display	Input range(°C)	Input range(°F)
Thermocouple	K(CA)	J:CRH	-50 to 1200	-58 to 2192
	J(IC)	J:JLH	-30 to 800	-22 to 1472
	L(IC)	J:JLL	-30.0 to 800.0	-22.0 to 999.9
	T(CC)	E:CCH	-40 to 800	-40 to 1472
	R(PR)	E:RPH	-50 to 400	-58 to 752
	S(PR)	E:SPH	-50.0 to 400.0	-58.0 to 752.0
RTD	DP1 100Ω	d:PEH	-100 to 400	-148 to 752
		d:PEL	-100.0 to 400.0	-148.0 to 752.0
	Cu50Ω	c:USH	-50 to 200	-58 to 392
	c:USL	-50.0 to 200.0	-58.0 to 392.0	

■ Parameter Groups

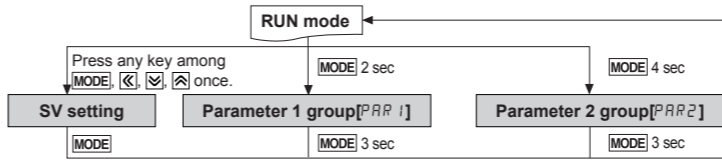

- ※ Order of parameter setup: Parameter 2 group → Parameter 1 group → SV setting
- All parameters are related one another. Set the parameters as above order.
- ※ If there is no key input for 30 sec. while setting SV or the parameters, the new settings are ignored, and the unit will return to RUN mode with previous settings.
- ※ When returning to RUN mode by holding the [MODE] key for over 3 sec, press the [MODE] key within 1 sec to re-enter the first parameter of previous parameter group.
- ※ Hold the [MODE] keys for 5 sec in RUN mode, to enter re-set parameter menu. Select 'E5' and all parameters are reset as factory default.

● SV setting

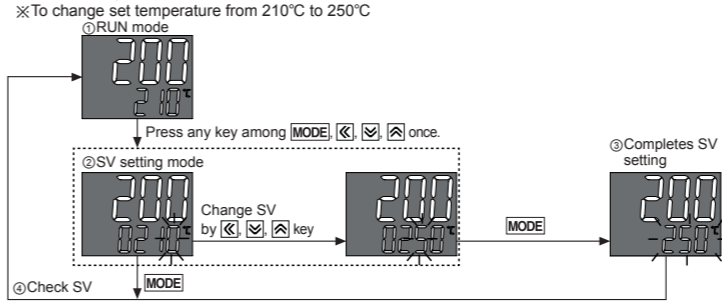

● Parameter 1 group

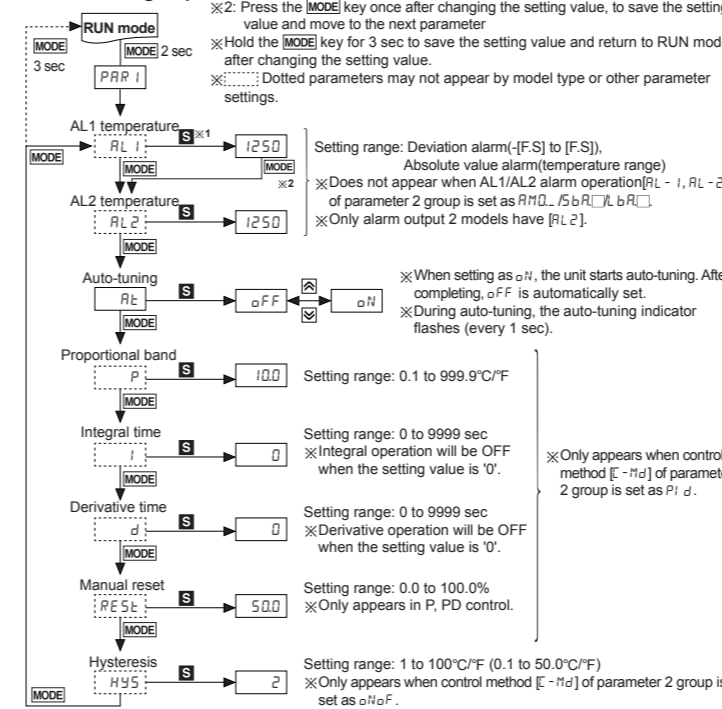

■ Dimensions

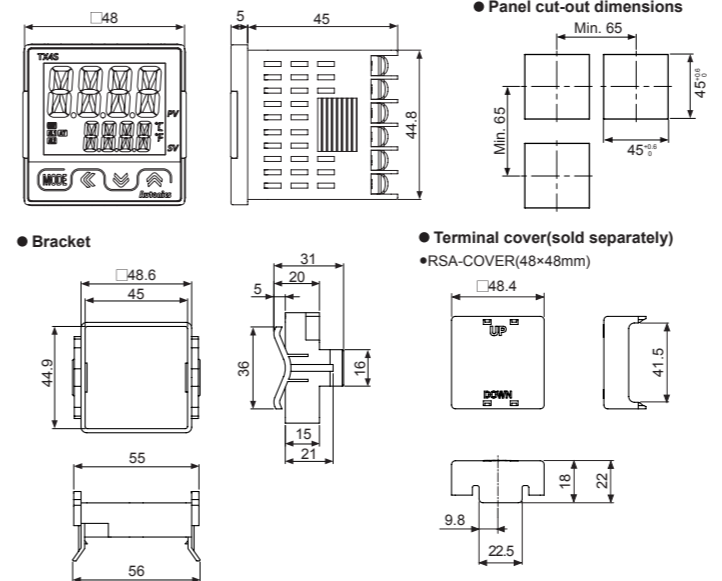

● Parameter 2 group

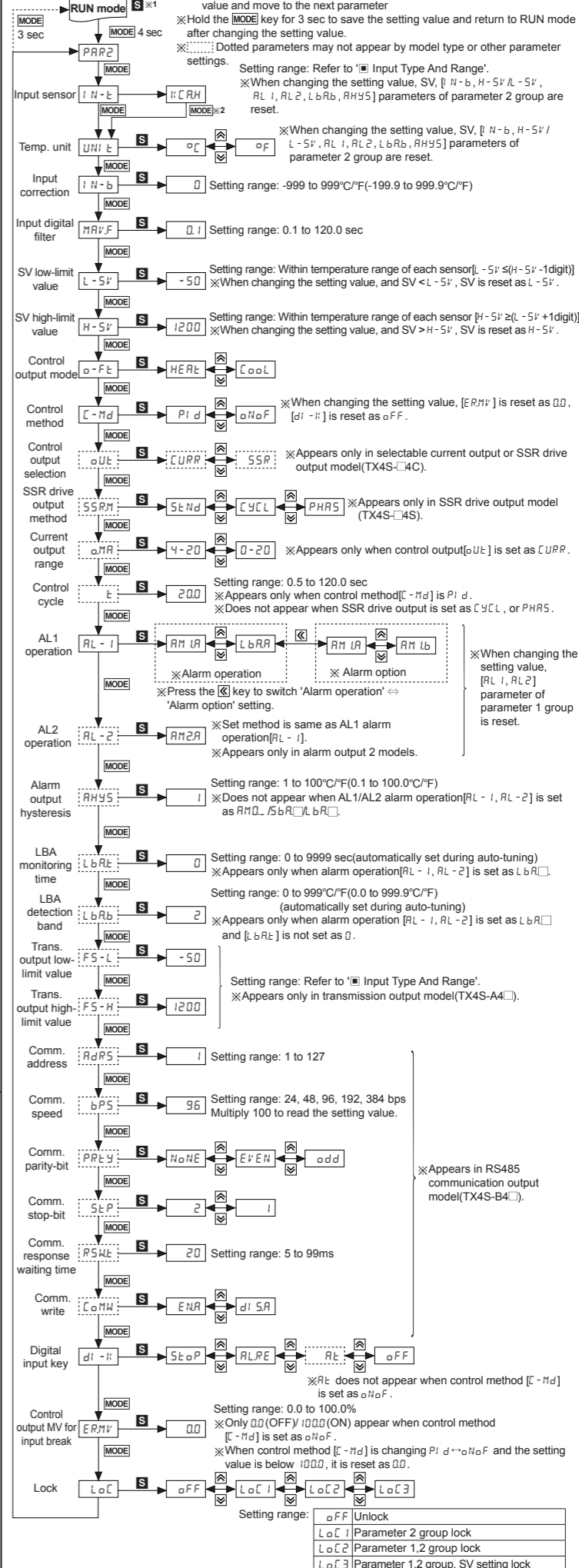

Alarm [AL-1/AL-2]

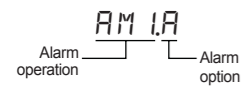

Set both alarm operation and alarm option by combining. Each alarm operates individually in two alarm output models. When the current temperature is out of alarm range, alarm clears automatically. If alarm option is alarm latch or alarm latch and standby sequence 1/2, press digital input key [3] 3 sec, digital input key [d1 - i:] of parameter 2 group set as $RLRE$, or turn OFF the power and turn ON to clear alarm.

Alarm operation

Mode	Name	Alarm operation	Description
RM0	-	-	No alarm output
RM1	Deviation high-limit alarm		If deviation between PV and SV as high-limit is higher than set value of deviation temperature, the alarm output will be ON.
RM2	Deviation low-limit alarm		If deviation between PV and SV as low-limit is higher than set value of deviation temperature, the alarm output will be ON.
RM3	Deviation high/low-limit alarm		If deviation between PV and SV as high/low-limit is higher than set value of deviation temperature, the alarm output will be ON.
RM4	Deviation high/low-limit reserve alarm		If deviation between PV and SV as high/low-limit is higher than set value of deviation temperature, the alarm output will be OFF.
RM5	Absolute value high limit alarm		If PV is higher than the absolute value, the output will be ON.
RM6	Absolute value low limit alarm		If PV is lower than the absolute value, the output will be ON.
5bRA	Sensor break alarm	-	It will be ON when it detects sensor disconnection.
6bRA	Loop break alarm	-	It will be ON when it detects loop break.

※ H: Alarm output hysteresis [RHYS]

Alarm option

Option	Name	Description
RM1A	Standard alarm	If it is an alarm condition, alarm output is ON. If it is a clear alarm condition, alarm output is OFF.
RM1b	Alarm latch	If it is an alarm condition, alarm output is ON and maintains ON status. (Alarm output HOLD)
RM1C	Standby sequence 1	First alarm condition is ignored and from second alarm condition, standard alarm operates. When power is supplied and it is an alarm condition, this first alarm condition is ignored and from the second alarm condition, standard alarm operates.
RM1d	Alarm latch and standby sequence 1	If it is an alarm condition, it operates both alarm latch and standby sequence. When power is supplied and it is an alarm condition, this first alarm condition is ignored and from the second alarm condition, alarm latch operates.
RM1E	Standby sequence 2	First alarm condition is ignored and from second alarm condition, standard alarm operates. When re-applied standby sequence and if it is alarm condition, alarm output does not turn ON. After clearing alarm condition, standard alarm operates.
RM1F	Alarm latch and standby sequence 2	Basic operation is same as alarm latch and standby sequence 1. It operates not only by power ON/OFF, but also alarm setting value, or alarm option changing. When re-applied standby sequence and if it is alarm condition, alarm output does not turn ON. After clearing alarm condition, alarm latch operates.

※Condition of re-applied standby sequence for standby sequence 1, alarm latch and standby sequence 1: Power ON
Condition of re-applied standby sequence for standby sequence 2, alarm latch and standby sequence 2: Power ON, changing set temperature, alarm temperature [RL1, RL2] or alarm operation [RL-1, RL-2], switching STOP mode to RUN mode.

Sensor break alarm

The function that alarm output will be ON when sensor is not connected or when sensor's disconnection is detected during temperature controlling. You can check whether the sensor is connected with buzzer or other units using alarm output contact. It is selectable between standard alarm [5bRA] or alarm latch [5bRB].

Loop break alarm(LBA)

It checks control loop and outputs alarm by temperature change of the subject. For heating control(cooling control), when control output MV is 100%(0% for cooling control) and PV is not increased over than LBA detection band [LbRb] during LBA monitoring time [LbRt], or when control output MV is 0%(100% for cooling control) and PV is not decreased below than LBA detection band [LbRb] during LBA monitoring time [LbRt], alarm output turns ON.

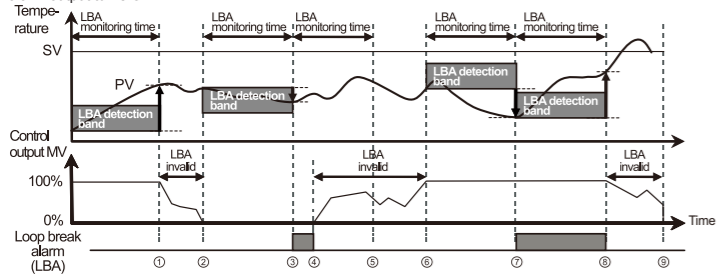

Start control to ①	When control output MV is 100%, PV is increased over than LBA detection band [LbRb] during LBA monitoring time [LbRt].
① to ②	The status of changing control output MV (LBA monitoring time is reset.)
② to ③	When control output MV is 0% and PV is not decreased below than LBA detection band [LbRb] during LBA monitoring time [LbRt], loop break alarm (LBA) turns ON after LBA monitoring time.
③ to ④	Control output MV is 0% and loop break alarm (LBA) turns and maintains ON.
④ to ⑥	The status of changing control output MV (LBA monitoring time is reset.)
⑥ to ⑦	When control output MV is 100% and PV is not increased over than LBA detection band [LbRb] during LBA monitoring time [LbRt], loop break alarm (LBA) turns ON after LBA monitoring time.
⑦ to ⑧	When control output MV is 100% and PV is increased over than LBA detection band [LbRb] during LBA monitoring time [LbRt], loop break alarm (LBA) turns OFF after LBA monitoring time.
⑧ to ⑨	The status of changing control output MV (LBA monitoring time is reset.)

※When executing auto-tuning, LBA detection band [LbRb] and LBA monitoring time are automatically set based on auto tuning value. When alarm operation mode [RL-1, RL-2] is set as loop break alarm(LBA) [6bRA], LBA detection band [LbRb] and LBA monitoring time [LbRt] parameter is displayed.

Functions

1. Input correction [N-b]

Controller itself does not have errors but there may be error by external input temperature sensor. This function is for correcting this error.

Ex) If actual temperature is 80°C but controller displays 78°C, set input correction value [N-b] as '2' and controller displays 80°C.
※As the result of input correction, if current temperature value (PV) is over each temperature range of input sensor, it displays HHHH or LLLL.

2. Input digital filter [HVF]

If current temperature (PV) is fluctuating repeatedly by rapid change of input signal, it reflects to MV and stable control is impossible. Therefore, digital filter function stabilizes current temperature value.

For example, set input digital filter value as 0.4 sec, and it applies digital filter to input values during 0.4 sec and displays these values. Current temperature may be different by actual input value.

3. SSR drive output method (SSRP function) [5SRM]

SSRP function is selectable one of standard ON/OFF control, cycle control, phase control by utilizing standard SSR drive output.

• This function parameter appears only in SSR drive output model (TX4S-□4S).

• Realizing high accuracy and cost effective temperature control with both current output (4-20mA) and linear output (cycle control and phase control)

• Select one of standard ON/OFF control [5Nd], cycle control [YCL], phase control [PHAS] at 5SRM parameter of parameter 2 group. For cycle control, connect a zero cross turn-on SSR or random turn-on SSR. For phase control, connect random turn-on SSR.

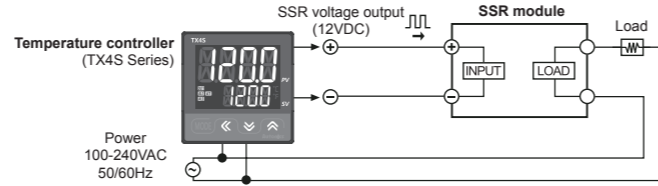

※When selecting cycle or phase control mode, the power supply for a load and a temperature controller must be the same.

※Control cycle [YCL] is able to set only when control method [Nd] of parameter group 2 is set as $Pi d$ and SSR drive output method [5SRM] is set as 5Nd.

※In case of selectable current output or SSR drive output model (TX4S-□4C), this parameter does not appear. Standard ON/OFF control by SSR is only available.

1) Standard ON/OFF control [5Nd]

Controls ON (100% output)/OFF (0% output) as same as standard relay output.



2) Cycle control [YCL]

Controls the load by repeating output ON / OFF according to the rate of output within setting cycle based on certain period (50-cycle).

Control accuracy is almost the same with phase control's.

This control has improved ON/OFF noise than phase control's due to zero cross type which turns ON/OFF at zero point of AC.



3) Phase control [PHAS]

Controls the load by controlling the phase within AC half cycle. Serial control is available.

Must use random turn-on SSR for this mode.



4. Current output range [oMRA]

In case of selectable current output or SSR drive output model (TX4S-□4C), when control output [oUe] parameter 2 group is set as [URR], you can select high/low-limit range, 4-20mA [4-2D] or 0-20mA [0-2D] of current output.

5. Hysteresis [HY5]

Set interval between ON and OFF of control output for ON/OFF control.

• If hysteresis is too narrow, hunting (oscillation, chattering) could occur due to external noise.

• In case of ON / OFF control mode, even if PV reaches stable status, there still occurs hunting. It could be due to hysteresis [HY5] setting value, load's response characteristics or sensor's location. In order to reduce hunting to a minimum, it is required to take into following factors consideration when designing temp. controlling: proper Hysteresis [HY5], heater's capacity, thermal characteristics, sensor's response and location.

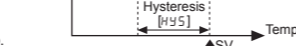

6. Manual reset [RE5t]

When selecting P/PD control mode, certain temperature difference exists even after PV reaches stable status because heater's rising and falling time is inconsistent due to thermal characteristics of controlled objects, such as heat capacity, heater capacity. This temperature difference is called offset and manual reset [RE5t] function is to set/correct offset.

When PV and SV are equal, reset value is 50.0%. After control is stable, PV is lower than SV, reset value is over 50.0% or PV is higher than SV, reset value is below 50.0%.

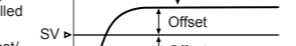

• Manual reset [RE5t] by control result

Set below 50.0 as reset value

Set over 50.0 as reset value

7. Digital input key [3 sec] [d1 - i:]

Parameter	Operation	Description
OFF	oFF	It does not use digital input key function.
RUN/STOP	5t oP	Pauses control output. Auxiliary output (except loop break alarm, sensor break alarm) except control output operates as setting. Hold the digital input keys for 3 sec to restart. Digital input key (t: over 3 sec)
Clear alarm	RLRE	Clears alarm output by force. (only when alarm option is alarm latch, or alarm latch and standby sequence 1/2.) This function is applied when present value is out of alarm operation range but alarm output is ON. Alarm operates normally right after clearing alarm.
Auto-tuning	RL	Starts/Stops auto-tuning. This function is same as auto-tuning [RLt] of parameter 1 group. (You can start auto-tuning [RLt] of parameter 1 group and stop it by digital input key.) ※ This parameter RL appears only when control method [Nd] parameter 2 group is set as $Pi d$. When control method [Nd] parameter 2 group is set as $oH oF$, this parameter is changed as oFF.

8. Control output MV for input break [ERMV]

When input sensor is break, set control output MV.

When control method [Nd] of parameter 2 group is set as $oH oF$, set control output MV as 0D (OFF) or 100D (ON). When control method [Nd] is set as $Pi d$, setting range for control output MV is 0D to 100D.

Comprehensive Device Management Program [DAQMaster]

DAQMaster is a comprehensive device management software for setting parameters and monitoring processes. DAQMaster can be downloaded from our web site at www.autonics.com.

Item	Minimum specifications
System	IBM PC compatible computer with Pentium III or above
Operations	Windows 98/NT/XP/Vista/7/8/10
Memory	256MB+
Hard disk	1GB+ of available hard disk space
VGA	Resolution: 1024x768 or higher
Others	RS232C serial port (9-pin), USB port

RS485 Communication Output

Applicable for models with RS485 communication output through option output (TX4S-B4□). Please refer to 'Ordering Information'.

1. Communication Specifications

Com. protocol	Modbus RTU	Com. speed	2400, 4800, 9600, 19200, 38400 bps
Applied standard	EIA RS485	Start-bit	1-bit fixed
Max. connections	31 units (address: 1 to 99)	Data-bit	8-bit fixed
Com. method	2-wire half duplex	Parity-bit	None, Even, Odd
Synchronization method	Asynchronous	Stop-bit	1, 2Bit
Com. distance	Within 800m	Com. response time	5 to 99ms

2. Modbus Mapping Table

2-1. Read Coil Status (Func 01) / Force Single Coil (Func 05) [Func: 01/05, R/W: R/W]

No.(Address)	Type	Description	Setting/Display range	Unit	Default
000001(0000)	RUN/STOP	Control output run/stop	0: RUN 1: 5t oP	-	5t oP
000002(0001)	AT	Auto-tuning run/stop	0: oFF 1: oN	-	oFF
000003(0003)	Alarm Reset	Alarm output clear	0: oFF 1: oN	-	oFF
000004 to 000050	Reserved				

2-2. Read Discrete Inputs (Func 02) [Func: 02, R/W: R]

No.(Address)	Type	Description	Setting/Display range	Unit	Default
100001(0000)	°C indicator	°C indicator	0: OFF 1: ON	-	-
100002(0001)	°F indicator	°F indicator	0: OFF 1: ON	-	-
100003(0002)	OUT indicator	Control output indicator	0: OFF 1: ON	-	-
100004(0003)	AT indicator	Auto-tuning indicator	0: OFF 1: ON	-	-
100005(0004)	AL1 indicator	Alarm output 1 indicator	0: OFF 1: ON	-	-
100006(0005)	AL2 indicator	Alarm output 2 indicator	0: OFF 1: ON	-	-
100006 to 100050	Reserved				

2-3. Read Input Registers (Func 04) [Func: 04, R/W: R]

No.(Address)	Type	Description	Setting/Display range	Unit	Default
300001 to 300100	Reserved				
300101(0064)	-	Product number H	-	-	Dedicated model number
300102(0065)	-	Product number L	-	-	Dedicated model number
300103(0066)	-	Hardware version	-	-	□
300104(0067)	-	Software version	-	-	□
300105(0068)	-	Model 1	-	-	"TX"
300106(0069)	-	Model 2	-	-	"4"
300107(006A)	-	Model 3	-	-	"S"
300108(006B)	-	Model 4	-	-	"14"
300109(006C)	-	Model 5	-	-	"R"
300110(006D)	-	Model 6	-	-	" "
300111(006E)	-	Model 7	-	-	" "
300112(006F)	-	Model 8	-	-	" "
300113(0070)	-	Model 9	-	-	" "
300114(0071)	-	Model 10	-	-	" "
300115(0072)	-	Reserved	-	-	-
300116(0073)	-	Reserved	-	-	-
300117(0074)	-	Reserved	-	-	-
300118(0075)	-	Coil status start address	-	0000	-
300119(0076)	-	Coil status quantity	-	0	-
300120(0077)	-	Input status start address	-	0000	-
300121(0078)	-	Input status quantity	-	0	-
300122(0079)	-	Holding register start address	-	0000	-
300123(007A)	-	Holding register quantity	-	0	-
300124(007B)	-	Input register start address	-	0000	-
300125(007C)	-	Input register quantity	-	0	-
300127 to 300200	Reserved				
301001(03E8)	PV	Present value	-1999 to 9999	°C/°F	-
301002(03E9)	DOT	Decimal point location	0.0, 1.00, 2.000, 3.0000	-	-
301003(03EA)	UNIT	Display unit	0: °C, 1: °F	-	-
301004(03EB)	SV	Setting value	Within L - Sv to H - Sv	°C/°F	0
301005(03EC)	°C indicator	Unit indicator	0: OFF 1: ON	-	-
	°F indicator	Unit indicator	0: OFF 1: ON	-	-
	OUT indicator	Control output indicator	0: OFF 1: ON	-	-
	AT indicator	Auto-tuning indicator	0: OFF 1: ON	-	-
	AL1 indicator	Alarm output 1 indicator	0: OFF 1: ON	-	-
	AL2 indicator	Alarm output 2 indicator	0: OFF 1: ON	-	-
310006 to 310050	Reserved				

2-4. Read Holding Register (Func 03)/Preset Single Register (Func 06)/Preset Multiple Registers (Func 16) [Func: 03/06/16, R/W: R/W]

2-4-1. SV setting

No.(Address)	Parameter	Description	Setting/Display range	Unit	Default
400001(0000)	Set value	SV setting value	Within L - Sv to H - Sv	°C/°F	0
400002 to 400050	Reserved				

2-4-2. Parameter 1 group [PAR1]

No.(Address)	Parameter	Description	Setting/Display range	Unit	Default
400051(0032)	RL1	AL1 temperature	Deviation temperature: -F.S. to F.S.	°C/°F	1250
400052(0033)	RL2	AL2 temperature	Absolute value alarm: Temperature range	-	-
400053(0034)	RE	Auto-tuning	0: oFF 1: oN	-	oFF
400054(0035)	P	Proportional band	1 to 9999: 0.1 to 999.9	°C/°F	100
400055(0036)	I	Integral time	0 to 9999: 0 to 999.9	Sec	0
400056(0037)	d	Derivative time	0 to 9999: 0 to 999.9	Sec	0
400057(0038)	RE5t	Manual reset	0 to 1000: 0D to 100D	%	50.0
400058(0039)	HY5	Hysteresis	1 to 100(1 to 500): 1 to 100(0.1 to 50.0)	-	2
400059 to 400100	Reserved				

2-4-3. Parameter 2 group [PAR2]

No.(Address)	Parameter	Description	Setting/Display range	Unit	Default
400101(0064)	INt-E	Input sensor	Refer to 'Input Type And Range'	-	ICRH
400102(0065)	UNI-E	Temperature unit	0: °C, 1: °F	-	°C
400103(0066)	INt-b	Input correction	-999 to 999(-1999 to 9999): -999 to 999(+999 to 9999)	-	0
400104(0067)	HVF-F	Input digital filter	1 to 1200: 0.1 to 120.0	Sec	0.1
400105(0068)	L-SV	SV low-limit value	Refer to 'Input Type And Range'	°C/°F	-50
400106(0069)	H-SV				