

# A Accessories

## Common Accessories

### Contact Blocks and LED Blocks for Ø16 Control Switches

#### Ordering Information



SA	16	CB	W		
Item		Applied switches		LED color <sup>※1</sup>	
		Type		LED block	
		CB <sup>※2</sup>		R Red	
		CC		B Blue	
		L5		G Green	
		L12		Y Yellow	
		L24		W White	
		Contact block		B contact (normally closed)	
		LED block		C contact (normally open, normally closed)	
				5VDC	
				12VDC	
				24VDC	
		16		For Ø16 control switches	
		SA		Switch Accessories	

※1. Only for LED blocks.

※2. Only for Ø16 emergency switches.

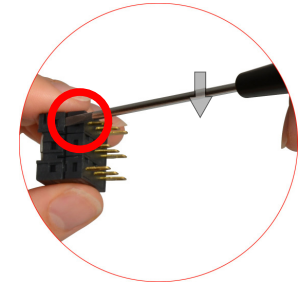
- **Contact block and LED block removal**  
Separate the unit using a flat-head (-) screwdriver.



Item	Appearance	Model	Type	Features
Contact block		SA16-CB	B contact (normally closed)	For Ø16 emergency switches
		SA16-CC	C contact (normally open, normally closed)	—
LED block		SA16-L5□ (5VDC) SA16-L12□ (12VDC) SA16-L24□ (24VDC)	DC voltage type	Diverse, vibrant, high luminance LEDs (red, blue, green, yellow, white)

## ■ Contact Blocks and LED Blocks for Ø22/25, Ø30, □30 Control Switches

### ○ Ordering Information





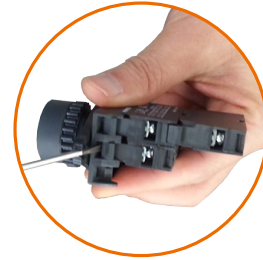



SA	—	CA	M															
				<table border="1" style="width: 100%; border-collapse: collapse;"> <tr> <td rowspan="2" style="width: 15%;">Contact block type</td> <td style="width: 15%;">No-mark</td> <td style="width: 15%;">Singular type</td> </tr> <tr> <td>M</td> <td>Modular type</td> </tr> </table>	Contact block type	No-mark	Singular type	M	Modular type									
Contact block type	No-mark	Singular type																
	M	Modular type																
				<table border="1" style="width: 100%; border-collapse: collapse;"> <tr> <td rowspan="5" style="width: 15%;">LED color<sup>※1</sup></td> <td style="width: 15%;">No-mark</td> <td style="width: 15%;">White</td> </tr> <tr> <td>R</td> <td>Red</td> </tr> <tr> <td>B</td> <td>Blue</td> </tr> <tr> <td>G</td> <td>Green</td> </tr> <tr> <td>Y</td> <td>Yellow</td> </tr> </table>	LED color <sup>※1</sup>	No-mark	White	R	Red	B	Blue	G	Green	Y	Yellow			
LED color <sup>※1</sup>	No-mark	White																
	R	Red																
	B	Blue																
	G	Green																
	Y	Yellow																
				<table border="1" style="width: 100%; border-collapse: collapse;"> <tr> <td rowspan="2" style="width: 15%;">Type</td> <td style="width: 15%;">CA</td> <td style="width: 15%;">Contact block</td> <td style="width: 15%;">A contact (normally open)</td> </tr> <tr> <td>CB</td> <td>B contact (normally closed)</td> <td></td> </tr> <tr> <td rowspan="2"></td> <td>LD</td> <td>LED block</td> <td>AC/DC voltage: 12-24VAC 50/60Hz 12-24VDC</td> </tr> <tr> <td>LA</td> <td></td> <td>AC voltage: 110-240VAC 50/60Hz</td> </tr> </table>	Type	CA	Contact block	A contact (normally open)	CB	B contact (normally closed)			LD	LED block	AC/DC voltage: 12-24VAC 50/60Hz 12-24VDC	LA		AC voltage: 110-240VAC 50/60Hz
Type	CA	Contact block	A contact (normally open)															
	CB	B contact (normally closed)																
	LD	LED block	AC/DC voltage: 12-24VAC 50/60Hz 12-24VDC															
	LA		AC voltage: 110-240VAC 50/60Hz															
				<table border="1" style="width: 100%; border-collapse: collapse;"> <tr> <td style="width: 15%;">No-mark</td> <td style="width: 15%;">For Ø22/25, Ø30, □30 control switches</td> </tr> <tr> <td>SA</td> <td>Switch Accessories</td> </tr> </table>	No-mark	For Ø22/25, Ø30, □30 control switches	SA	Switch Accessories										
No-mark	For Ø22/25, Ø30, □30 control switches																	
SA	Switch Accessories																	

• **Contact block and LED block removal**  
Separate the unit using a flat-head (-) screwdriver.



※1. Only for LED blocks.

※Multi-unit connection is only available for modular type (SA-□M).

Item	Appearance	Model	Type	Features
Modular type contact block		SA-CAM	A contact (normally open)	Ring or spade terminals / Multi-connection (up to 3 units)
		SA-CBM	B contact (normally closed)	
Singular type contact block		SA-CA	A contact (normally open)	Spade terminals only / Loose screw prevention
		SA-CB	B contact (normally closed)	
Modular type LED block		SA-LD□M	AC/DC voltage type 12-24VAC 50/60Hz 12-24VDC	Diverse, vibrant, high luminance LEDs (Red, Blue, Green, Yellow, White)
		SA-LA□M	AC voltage type 110-220VAC 50/60Hz	
Singular type LED block		SA-LD□	AC/DC voltage type 12-24VAC 50/60Hz 12-24VDC	
		SA-LA□	AC voltage type 110-220VAC 50/60Hz	

- Control Switches
- Ø16
- Ø22/25
- Ø30
- 30
- Push Button Switches
  - Round
  - Square
  - Rectangular
- Selector Switches
  - Round
  - Square
  - Rectangular
- Key Selector Switches
  - Round
  - Square
  - Rectangular
- Double Push Button Switches
- Mushroom-head Push Button Switches
- Emergency Switches
- Pilot Lights
- Accessories
- Buzzers

# A Accessories

## Switch Enclosures for Ø22/25 Control Switches

### Ordering Information

SA	SB	3		
Item	Applied switch	Appearance	Holes	
			1	1 hole
			2	2 holes
			3	3 holes
			4	4 holes
Item	Applied switch	Appearance	SB	Square type
			TB	Triangle type
Item	Applied switch	Appearance	No-mark	For Ø22/25 control switches
			SA	Switch accessories

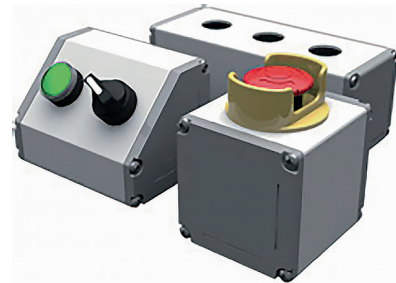

※You can order the other size and the number of holes.

• Hole size: Ø22.5/25.5mm

(unit: mm)

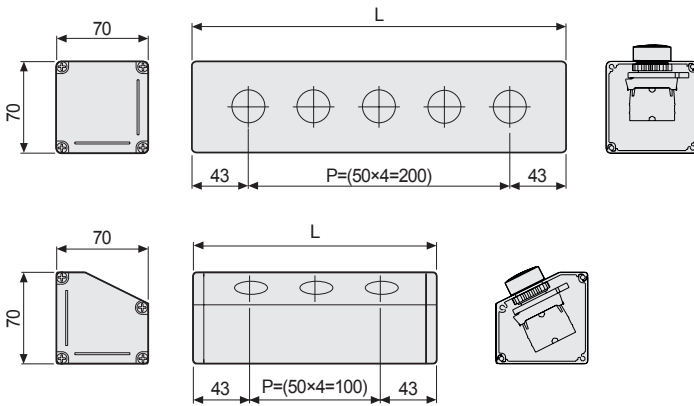

Holes	L
1	86mm
2	136mm
3	186mm
4	236mm
5	286mm

## Locking Handle for Switches

Applied switches	Appearance	Model	Note
Ø16		SA16-LH	For locking switch nuts behind the panels
Ø22/25, Ø30 <sup>※1</sup> , □30		SA-LH	

※1. Except Ø30 round pressure switches (extended).

## Accessories By Item

(unit: mm)

Item	Appearance	Model	Dimensions	Note						
Emergency switch nameplates		SA-NS	Size : D60×d25	Standard and illuminated nameplates are available for emergency switches. ※ Illuminated nameplates are optional. ※ D60 emergency switches (S2ER-E5R□) are not compatible with SA-NS nameplates						
		SA-NL	Size : D80×d25							
Protective shrouds for emergency switches		SA-EG1		Protective shrouds to prevent accidental/incorrect operation <table border="1" style="width: 100%; border-collapse: collapse;"> <thead> <tr> <th colspan="2">D</th> </tr> </thead> <tbody> <tr> <td>SA-EG2</td> <td>Ø22.5</td> </tr> <tr> <td>SA-EG3</td> <td>Ø25.5</td> </tr> </tbody> </table> ※ Not available for D60 emergency switches (S2ER-E5R□).	D		SA-EG2	Ø22.5	SA-EG3	Ø25.5
	D									
SA-EG2	Ø22.5									
SA-EG3	Ø25.5									
	SA-EG2/ SA-EG3									
Waterproof cap for Ø22/25 round push button switches		SA-WP (non-illuminated/ extended)		IP65 protection structure with waterproof cap						
		SA-WL (illuminated/ extended)								
Lens remover for Ø16 push button control switches or pilot lights		SA16-RM		Lens remover for push button control switches or pilot lights						

- Control Switches
  - Ø16
  - Ø22/25
  - Ø30
  - 30
- Push Button Switches
  - Round
  - Square
  - Rectangular
- Selector Switches
  - Round
  - Square
  - Rectangular
- Key Selector Switches
  - Round
  - Square
  - Rectangular
- Double Push Button Switches
- Mushroom-head Push Button Switches
- Emergency Switches
- Pilot Lights
- Accessories
- Buzzers