

PTM Series D56mm LED 3 Colors in 1 Tower Light



Versatile, cost and energy efficient LED Signal Tower for every need.



Feature

- 3 colors in 1 LED modular components
- Bright & even light distribution through prism-cut lenses
- Fast & easy assembly with inter-locking construction
- 8 mounting options
- Optional 80dB Buzzer (fixed or adjustable volume)
- IP65 rated
- RoHS compliant



Ordering Information

PTM- A P F - 1 02 - RYG - B (V)

① ② ③ ④ ⑤ ⑥ ⑦ ⑧

* Options

1. Body Unit

			Apply to Mounting style
S	Flat Based Body	Code7	C
A	Pole Mount Standard Body	Code7 + Code10	G/P/R/M/W/D/J
D	Short Body	Code6	P/R/M/W/D/J
T	Terminal Body	Code15	G/P/R/M/W/D/J
L	Small Surface Body	Code17	C

Note: "D", "L" Type - Power Supply 24VAC/DC Only

2. Mounting Style

C	Surface mount	Code 18
G	Plastic mount base (MAM-B070F)	Code 8 + Code 16
P	Pole + Plastic mount base (MAM-B070D)	Code 8 + Code 11
R	Pole + Rotate plastic mount base (MAM-B070R)	Code 8 + Code 20
M	Pole + Plastic M20 screw mount base (MAM-I025)	Code 8 + Code 9
W	Pole + Wall mount bracket (MAP-DS40)	Code 8 + Code 12
D	Pole + Aluminum pole mount base (MAM-DS32)	Code 8 + Code 22
J	Pole Adjustable Type	Code 21 + Code 11

Note: R type Mount base - 180-degree revolution

3. Light Style

	Steady Light
F	Steady + Flashing Light
B	Buzzer (Fixed Sound)
V	Buzzer (Adjustable Sound)
Z	Steady + Flashing + Buzzer (Fixed Sound)
X	Steady + Flashing + Buzzer (Adjustable Sound)

4. Number of Stacks

1	1 Stack
----------	---------

5. Power Supply

02	24VAC/DC
FF	90 ~ 240VAC

6. LED Colors

RYG	Red, Yellow, Green
RGB	Red, Green, Blue

Options

7. Body Color	
B	Black
Note: Standard Body Color - White Ivory	
8. Light Style	
(V)	Continuous Flashing Flashing Cycle: (240times/minute)
(C)	Buzzer Continuous sound
(H)	Buzzer 10-100dB type - Adjustable Sound

Exploded View / Part Code

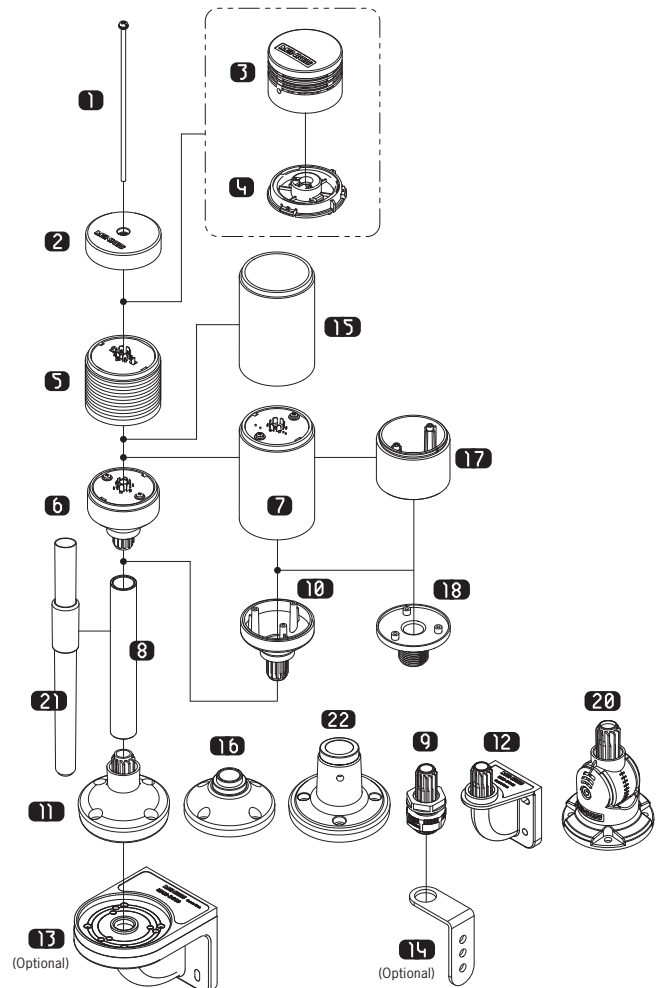

See Page 56 ~ 58
for Mounting Options and Accessories.

Specifications

Body Units

Operation/Function	Steady, Flashing, Buzzer
Power Supply	24VAC/DC, 90 ~ 240VAC (50/60Hz)
Lens Color	Clear
Maximum Tier	1
Flash Rate (±10%)	80times/minute, 240times/minute (Option 'V' type)
Vibration	0.75mm at 10~55Hz
Ambient Temperature	-15 to 40°C
Storage Temperature	-20 to 70°C
Ambient Humidity	45~85% RH
Degree of Protection	IP65 / IP50 (with Buzzer)
Approvals	CE, UL, RoHS
Recommended Wire Size	UL1007 / 22AWG

Current consumption

LED Unit	Current	
	24V	90 ~ 240V
3 Colors in 1	RYG. 35mA	RYG. 16mA
	RGB. 35mA	RGB. 16mA
	(Maximum)	(Maximum)
Weight	App. 43g	

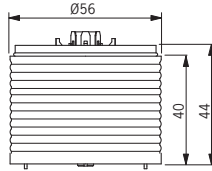

Buzzer Kits

Type	Standard Buzzer Sound - pi pi pi pi		
Model	MPZ-56F	MPZ-56G	MPZ-56H
Level Style	Fixed Sound	Adjustable Sound Level	Adjustable Sound Level
Sound Level	80±5dB at 1m	10~80±5dB at 1m	10~100±5dB/1m
Current / Power	30mA / 0.72W	30mA / 0.72W	150mA / 3.6W

Dimensions <Unit: mm>

▶ Standard Pole Length : 225mm

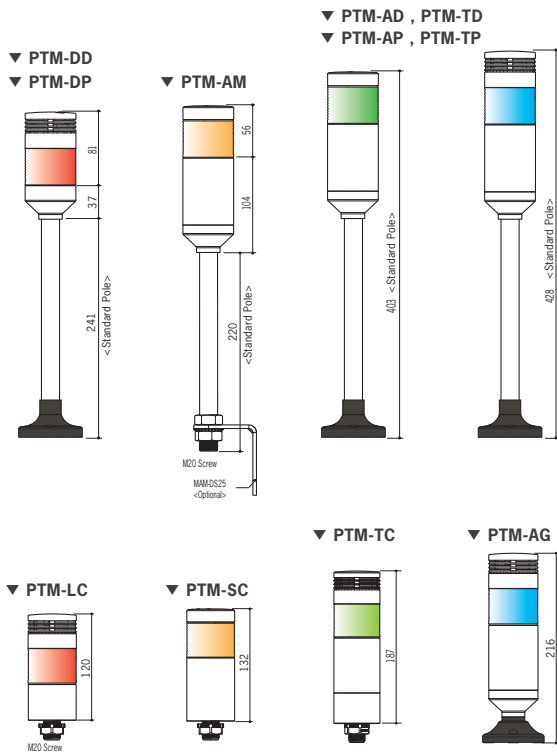

* The above specifications are changeable at anytime without notice.

Wiring Diagram

24VAC/DC Steady Lights (with Buzzer)

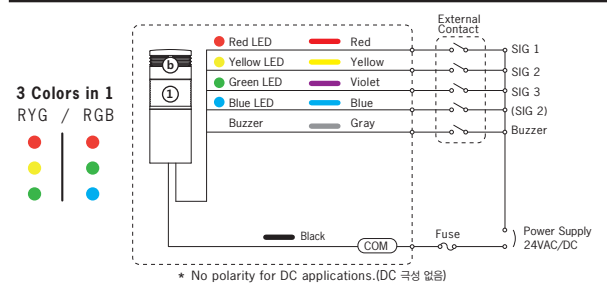

90 ~ 240VAC Steady Lights (with Buzzer)

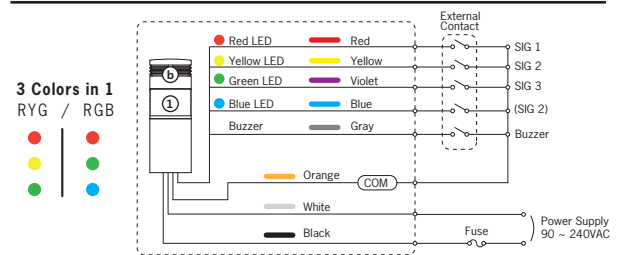

24VAC/DC, 90 ~ 240VAC Steady or Flashing Lights (with Buzzer)

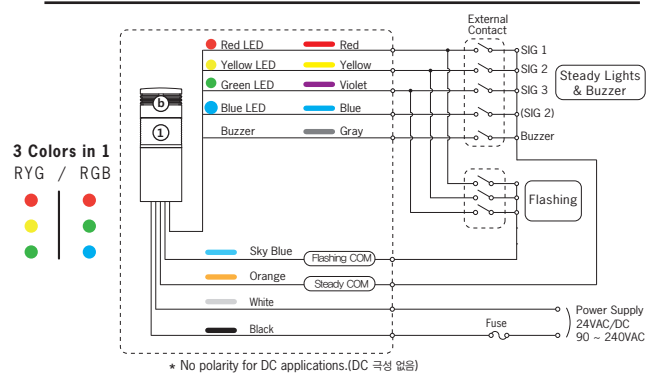

Terminal Type Connections

Pin #	Description
1	Red LED
2	Yellow LED
3	Green LED
4	Blue LED
5	Buzzer
6	Steady COM
7	Flashing COM
A	Power Supply (-)
B	Power Supply (+)

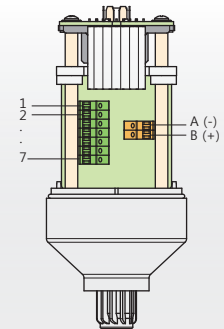

Recommended Wire Size
 UL 1007 AWG 22~16
 UL 1430 AWG 22~16
 * Use 75°C CU Wire only.

Buzzer Kits Dimensions

