

Multi-Channel Modular Type High Performance  
Temperature Controller **TMH Series**

**USER MANUAL**



TMH Series

Thank you very much for selecting Autonics products.

**For your safety, please read the following before using.**



# ***Preface***

Thank you for purchasing an Autonics product.





This user manual contains information about the product and its proper use, and should be kept in a place where it will be easy to access.

# ***User Manual Guide***

This user manual contains information about the product and its proper use, and should be kept in a place where it will be easy to access.

- Please familiarize yourself with the information in this manual before using the product.
- This manual provides detailed information on the product's features. It does not offer any guarantee concerning matters beyond the scope of this manual.
- This manual may not be edited or reproduced in either part or whole without permission.
- A user manual is not provided as part of the product package. Visit [www.autonics.com](http://www.autonics.com) to download a copy.
- The manual's content may vary depending on changes to the product's software and other unforeseen developments within Autonics, and is subject to change without prior notice.

# User Manual Symbols

Symbol	Description
 <b>Note</b>	Supplementary information for a particular feature.
 <b>Warning</b>	Failure to follow instructions can result in serious injury or death.
 <b>Caution</b>	Failure to follow instructions can lead to a minor injury or product damage.
 <b>Ex.</b>	An example of the concerned feature's use.
※1	Annotation mark.

# Safety Considerations

- Following these safety precautions will ensure the safe and proper use of the product and help prevent accidents, as well as minimizing possible hazards.
- Safety precautions are categorized as Warnings and Cautions, as defined below:

 <b>Warning</b>	<b>Warning</b>	Failure to follow the instructions may lead to a serious injury or accident.
--	----------------	--

 <b>Caution</b>	<b>Caution</b>	Failure to follow the instructions may lead to a minor injury or accident.
--	----------------	--

## Warning

- Fail-safe device must be installed when using the unit with machinery that may cause serious injury or substantial economic loss. (e.g. nuclear power control, medical equipment, ships, vehicles, railways, aircraft, combustion apparatus, safety equipment, crime/disaster prevention devices, etc.)  
Failure to follow this instruction may result in fire, personal injury, or economic loss.
- Install on a device panel to use.  
Failure to follow this instruction may result in fire.
- Do not connect, repair, or inspect the unit while connected to a power source.  
Failure to follow this instruction may result in fire.
- Check 'Connections' before wiring.  
Failure to follow this instruction may result in fire.
- Do not disassemble or modify the unit.  
Failure to follow this instruction may result in fire.

## Caution

- When connecting the power input and relay output, use AWG 20 (0.50mm<sup>2</sup>) cable or over and tighten the terminal screw with a tightening torque of 0.74 to 0.90N·m.  
When connecting the sensor input and communication cable without dedicated cable, use AWG 28 to 16 cable and tighten the terminal screw with a tightening torque of 0.74 to 0.90 N·m.  
Failure to follow this instruction may result in fire or malfunction due to contact failure.
- Use the unit within the rated specifications.  
Failure to follow this instruction may result in fire or product damage.
  - Use dry cloth to clean the unit, and do not use water or organic solvent.  
Failure to follow this instruction may result in fire.
  - Do not use the unit in the place where flammable/explosive/corrosive gas, humidity, direct sunlight, radiant heat, vibration, impact, or salinity may be present.  
Failure to follow this instruction may result in fire or explosion.
  - Keep metal chip, dust, and wire residue from flowing into the unit.  
Failure to follow this instruction may result in fire or product damage.

## Caution during Use

- Follow instructions in 'Cautions during Use'. Otherwise, It may cause unexpected accidents.
- Check the polarity of the terminals before wiring the temperature sensor. For RTD temperature sensor, wire it as 3-wire type, using cables in same thickness and length. For thermocouple (CT) temperature sensor, use the designated compensation wire for extending wire.
- Keep away from high voltage lines or power lines to prevent inductive noise. In case installing power line and input signal line closely, use line filter or varistor at power line and shielded wire at input signal line. Do not use near the equipment which generates strong magnetic force or high frequency noise.
- Do not apply excessive power when connecting or disconnecting the connectors of the product.
- Install a power switch or circuit breaker in the easily accessible place for supplying or disconnecting the power.
- Do not use the unit for other purpose (e.g. voltmeter, ammeter), but temperature controller.
- When changing the input sensor, turn off the power first before changing. After changing the input sensor, modify the value of the corresponding parameter.
- Power supply should be insulated and limited voltage/current or Class 2, SELV power supply device.
- Do not overlapping communication line and power line. Use twisted pair wire for communication line and connect ferrite bead at each end of line to reduce the effect of external noise.
- Make a required space around the unit for radiation of heat. For accurate temperature measurement, warm up the unit over 20 min after turning on the power.
- Make sure that power supply voltage reaches to the rated voltage within 2 sec after supplying power.
- Do not wire to terminals which are not used.
- Install DIN rail vertically from the ground.
- This unit may be used in the following environments.
  - ① Indoors (in the environment condition rated in 'Specifications')
  - ② Altitude max. 2,000m
  - ③ Pollution degree 2
  - ④ Installation category II

The above specifications are subject to change and some models may be discontinued without notice.

Be sure to follow cautions written in the instruction manual, user manual and the technical descriptions (catalog, homepage).





# Table of Contents

	Preface .....	iii
	User Manual Guide .....	iv
	User Manual Symbols .....	v
	Safety Considerations .....	vi
	Caution during Use.....	vii
	Table of Contents .....	ix
<b>1</b>	<b>Product Introduction.....</b>	<b>13</b>
	<b>1.1</b> Features .....	13
	<b>1.2</b> Components and accessories .....	14
	<b>1.3</b> Models .....	19
	<b>1.3.1</b> TMH2/4 Series [control module].....	19
	<b>1.3.2</b> TMHA/E/CT/C [option module].....	19
	<b>1.4</b> Unit description and function .....	20
	<b>1.4.1</b> TMH2/4 Series [control module].....	20
	<b>1.4.2</b> TMHA/E/CT/C [option module].....	22
<b>2</b>	<b>Specifications.....</b>	<b>25</b>
	<b>2.1</b> TMH2/4 Series [control module].....	25
	<b>2.2</b> TMHA/E/CT/C [option module].....	27
<b>3</b>	<b>Connections and Insulation Block Diagram .....</b>	<b>31</b>
	<b>3.1</b> Connections by Series.....	31
	<b>3.1.1</b> TMH2 Series [2 channels, control module] .....	31
	<b>3.1.2</b> TMH4 Series [4 channels, control module] .....	32
	<b>3.1.3</b> TMHA [analog input/output module].....	33
	<b>3.1.4</b> TMHE [digital input/alarm output module] .....	33
	<b>3.1.5</b> TMHCT [CT input module] .....	34
	<b>3.1.6</b> TMHC [RS422/RS485 comm. output module].....	34
	<b>3.2</b> Caution for connection.....	35
<b>4</b>	<b>Dimensions.....</b>	<b>37</b>
	<b>4.1</b> Installation.....	37
<b>5</b>	<b>Preparation and Startup .....</b>	<b>41</b>
	<b>5.1</b> General process .....	41
	<b>5.2</b> Setup values when power ON .....	41
<b>6</b>	<b>Connection examples .....</b>	<b>43</b>
	<b>6.1</b> TMH2/4 connection.....	43
	<b>6.2</b> TMH2/4, TMHA, TMHE, TMHCT interworking configuration example.....	45
	<b>6.3</b> TMHC interworking configuration example .....	46
<b>7</b>	<b>Parameter Settings and Functions.....</b>	<b>47</b>
	<b>7.1</b> Input .....	47
	<b>7.1.1</b> Input type and range <span style="border: 1px solid black; padding: 2px;">TMH2/4</span> <span style="border: 1px solid black; padding: 2px;">TMHA</span> .....	47

7.1.2	Input type	TMH2/4	TMHA	48			
7.1.3	Sensor temperature unit	TMH2/4	TMHA	49			
7.1.4	Analog high/low-limit input value	TMH2/4	TMHA	49			
7.1.5	Analog scale value decimal point position	TMH2/4	TMHA	50			
7.1.6	Analog scale high/low-limit value	TMH2/4	TMHA	50			
7.1.7	Analog input special function	TMH2/4	TMHA	51			
7.1.8	Input correction	TMH2/4	TMHA	53			
7.1.9	Input digital filter	TMH2/4	TMHA	54			
7.1.10	SV high/low-limit value	TMH2/4		55			
7.1.11	Remote SV (RSV)	TMH2/4		56			
7.2	Control output	TMH2/4		59			
7.2.1	Control output mode			59			
7.2.2	Dead band / Overlap band			60			
7.2.3	MV high/low-limit value			64			
7.2.4	MV change rate limit			65			
7.2.5	Ramp			66			
7.2.6	Soft start			68			
7.2.7	Auto/ Manual control			68			
7.2.8	Control output			70			
7.2.9	Current output range			70			
7.3	Analog transmission output	TMHA		71			
7.3.1	Analog transmission output			71			
7.3.2	Transmission output target address			71			
7.3.3	Transmission output target channel			71			
7.3.4	Current output range			72			
7.3.5	Transmission output high/low-limit value			72			
7.4	Temperature control	TMH2/4		73			
7.4.1	Temperature control method			73			
7.4.2	ON/OFF control			73			
7.4.3	PID control			74			
7.4.4	Auto-tuning			77			
7.5	Alarm output			79			
7.5.1	Alarm configurations			79			
7.5.2	Alarm output mode	TMH2/4		81			
7.5.3	Alarm output option	TMH2/4		82			
7.5.4	Alarm SV	TMH2/4		83			
7.5.5	Alarm output hysteresis	TMH2/4		84			
7.5.6	Alarm output delay time	TMH2/4		84			
7.5.7	Alarm output method	TMH2/4	TMHE	85			
7.5.8	Alarm output target address	TMH2/4		85			
7.5.9	Alarm output target channel	TMH2/4		86			
7.5.10	Alarm output logic operation	TMH2	TMHE	86			
7.5.11	Loop break alarm(LBA)	TMH2/4		87			
7.5.12	Sensor break alarm	TMH2/4		90			
7.5.13	Heater break alarm	TMH2/4		90			
7.5.14	Alarm output deactivation	TMH2/4		96			
7.5.15	Operation example for alarm output			96			
7.6	Communication	TMH2/4	TMHA	TMHE	TMHCT	TMHC	99
7.6.1	Communication address						99
7.6.2	Communication speed						100

7.6.3	Communication parity bit.....	100
7.6.4	Communication stop bit.....	100
7.6.5	Communication response wait time .....	101
7.6.6	Enable/Disable communications writing .....	101
7.6.7	USB to Serial communication connection .....	102
7.7	Monitoring .....	103
7.7.1	Control output MV monitoring <b>TMH2/4</b> .....	103
7.7.2	Heating MV monitoring <b>TMH2/4</b> .....	103
7.7.3	Cooling MV monitoring <b>TMH2/4</b> .....	103
7.7.4	Heater current value monitoring <b>TMH2/4</b> .....	103
7.7.5	CT input value monitoring <b>TMHCT</b> .....	104
7.7.6	CT input value indicators channel <b>TMHCT</b> .....	104
7.8	RUN/STOP <b>TMH2/4</b> .....	105
7.8.1	STOP, Control output .....	105
7.8.2	STOP, Alarm output.....	105
7.9	Multi SV <b>TMH2/4</b> .....	106
7.9.1	Number of multi SVs .....	106
7.9.2	Multi SV No. ....	106
7.9.3	Multi SV .....	106
7.10	Digital input <b>TMH2/4</b> .....	107
7.10.1	Digital input target address .....	107
7.10.2	Digital input terminal.....	107
7.11	Error <b>TMH2/4</b> .....	109
7.11.1	Sensor error, MV .....	109
7.12	Parameter reset <b>TMH2/4</b> <b>TMHA</b> <b>TMHE</b> <b>TMHCT</b> <b>TMHC</b> .....	110
<b>8</b>	<b>Simple Error Diagnosis .....</b>	<b>111</b>
<b>8.1</b>	Error display.....	111
<b>8.2</b>	Trouble shootings .....	111
<b>9</b>	<b>Comprehensive Device Management Program (DAQMaster).....</b>	<b>112</b>
<b>9.1</b>	Overview .....	112
<b>9.2</b>	Features.....	113
<b>9.3</b>	Special feature for TMH Series.....	114
<b>9.4</b>	Save parameter values.....	114
<b>9.4.1</b>	Copy parameters.....	117
<b>9.4.2</b>	User parameter group .....	121



# 1 Product Introduction

## 1.1 Features

TMH Series multi channel module type temperature controller controls 4 /2 channels with high speed sampling (50ms) via one unit. Side connector connection makes less wiring work and close mounting possible for up to 32 units, 128 channels without additional power and communication wires for expansion modules.

Control and basic module, TMH, connects option modules, TMHA (analog input/output module), TMHE(digital input/alarm output module), TMHCT(CTinput module), TMHC(communicaiton module) for various input/output, alarm, and communication function.

PC parameter setting and monitoring is possible via RS485 communication or dedicated USB cable. In addition, more reliable temperature heating/cooling controlling can be realized via various convenient functions.

[Common]

- Easy maintenance with separated body/base parts
- No communication and power supply for expansion modules required using module connectors: Up to 32 modules
- PC parameter setting via PC (USB cable and RS485 communication): Supports comprehensive device management program (DAQMaster)
  - ※ Communication converter, sold separately: SCM-US(USB/Serial converter), SCM-38I(RS232C/RS485 converter), SCM-US48I(USB/RS485 converter), SCM-WF48(Wi-Fi/RS485-USB wireless communication converter), EXT-US (converter cable)

[TMH2/4 Series (control module)]

- One module supports multi channels(2 channels/4 channels) for input/output control : connecting TMH2/4, up to 32 modules(2 channels: 64 channels/4 channels: 128 channels)
- High-speed sampling with 50ms and  $\pm 0.3\%$  measuring accuracy
- Simultaneous heating/cooling control and auto/manual control for high-performance control
- Selectable current output or SSR drive output
- Each channel insulated (dielectric strength 1,000VAC)
- CT input terminal for measuring load current (※CT, sold separately: CSTC-E80LN, CSTC-E200LN, CSTS-E80PP)
- Multi input/Multi range

[TMHA(analog input/output option module)]

- 4 channels, multi input/multi range/transmission output(DC0-20mA or 4-20mA)
- Each channel insulated (dielectric strength 1,000VAC)
- High-speed sampling with 50ms and  $\pm 0.3\%$  measuring accuracy

[TMHE(digital input/Alarm output option module)]

- Digital input (8 types)/Alarm output(8 types)

[TMHCT (CT input option module)]

- 8 CT inputs
- CT input status indicators

[TMHC (communication option module)]

- Connection expansion to master devices (PC, PLC, etc) with TMH2/4 (control module) and TMHA/E/CT (option module) (up to 16 modules)
- One module connects up to 32 control /option modules
- RS422 or RS485 communication

## 1.2 Components and accessories

### (1) Components

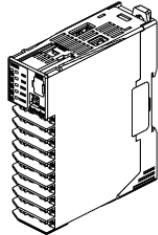

TMH□ Series

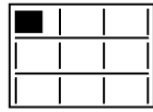

Instruction manual

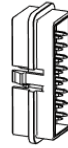

Expansion connector

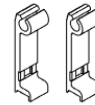

Module lock connector







### Note

- Make sure all listed components are included with your product before use. If any components are missing or damaged, please contact our sales department or your dealer.
- Note that power supply/communications connectors are provided with basic modules only.

### (2) Accessories (sold separately)

- Communication converter

SCM-WF48 (Wi-Fi to RS485-USB wireless communication converter)	SCM-US48I (USB to RS485 converter)	
		
SCM-38I (RS232C to RS485 converter)	SCM-US (USB to Serial converter)	EXT-US (converter cable)
		

CT connector cable

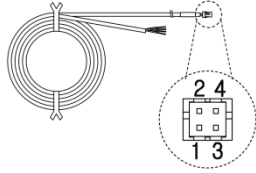
CICT4-1 (cable length: 1m)	CICT4-3 (cable length: 3m)
※When connecting CT connector and CT input terminal, align the concave part (凹) and the convex part (凸).	
	

Current transformer (CT)

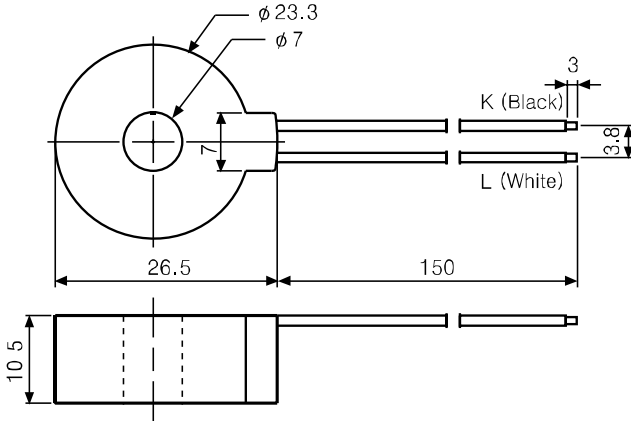
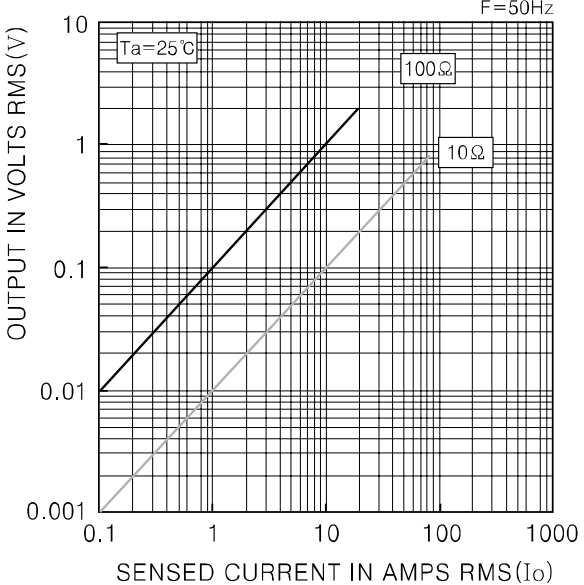
CSTC-E80LN <ul style="list-style-type: none"> <li>• Max. load current: 80A(50/60Hz)</li> <li>※ Max. load current for TMH Series is 50A.</li> <li>• Current ratio: 1/1000</li> <li>• Wire wounded resistance: <math>31\Omega \pm 10\%</math></li> </ul>	(unit: mm)
	
	

CSTC-E200LN

- Max. load current: 200A(50/60Hz)
- ※ Max. load current for TMH Series is 50A.
- Current ratio: 1/1000
- Wire wounded resistance:  $20\Omega \pm 10\%$

(unit: mm)

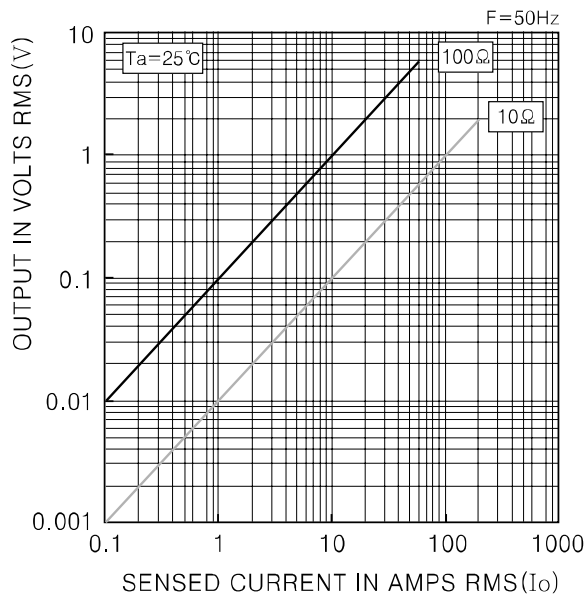
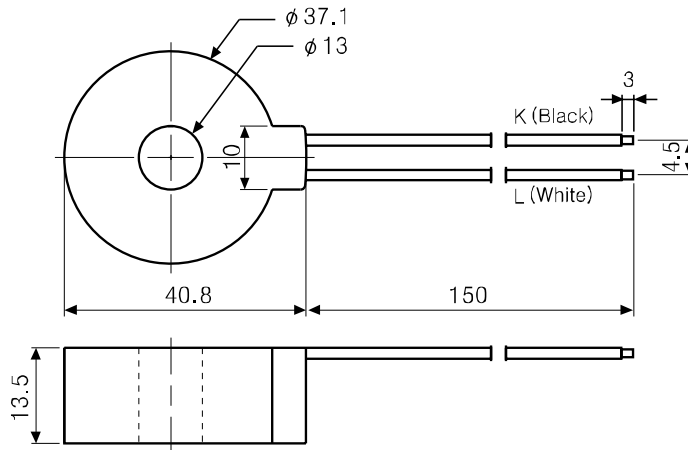



## CSTS-E80PP

- Max. load current: 80A(50/60Hz)
- ※ Max. load current for TMH Series is 50A.
- Current ratio: 1/1000
- Wire wounded resistance:  $31\Omega \pm 10\%$

(unit: mm)

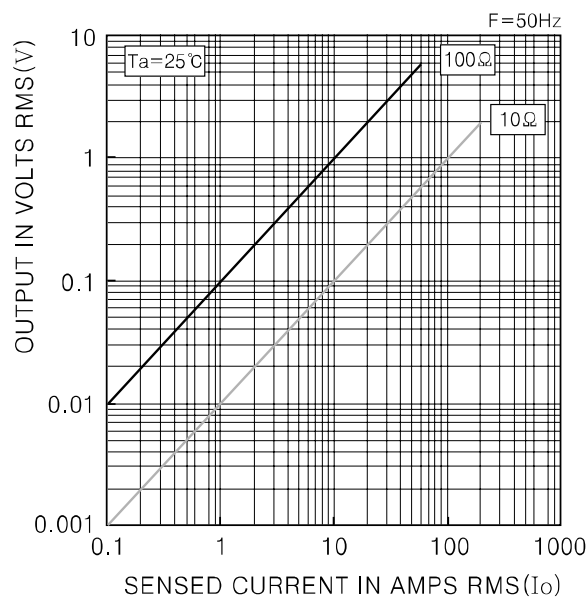
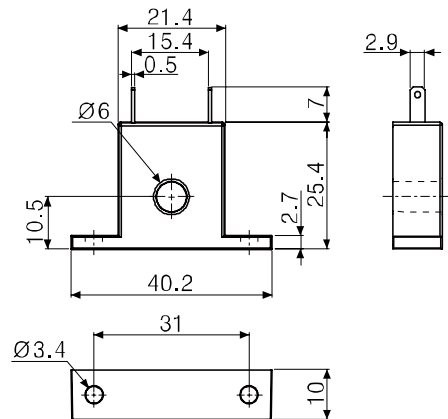

 **Caution**

For using CT, do not supply first part current when opening CT output.  
It occurs high voltage at CT output part.

Using current of above CTs are same as 50A. But be sure that inner hole sizes are different.  
Select it properly for the environment.

## ▪ Display unit

DS/DA-T Series (RS485 communication input type display unit)



Connect RS485 communication input type display unit (DS/DA-T Series) and TM Series, the display unit displays present value of the device without PC/PLC.

**Note**

- Images of components and accessories may differ from actual products.
- For more information about any of the above products, please refer to the concerned product's user manual. Visit our website ([www.autonics.com](http://www.autonics.com)) to download it.

## 1.3 Models

### 1.3.1 TMH2/4 Series [control module]

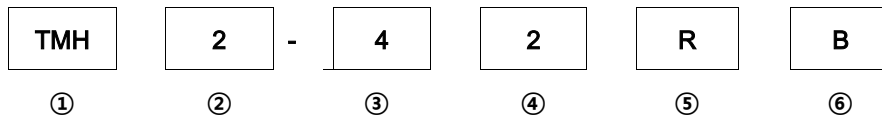

Category	Description		
① Item	TMH	Advanced Multi-Channel Modular Temperature Controller	
② Channel	2	2 channels	
	4	4 channels	
③ Input/Output option	2CH	2	CT input, digital input (DI-1/2), alarm output 1/2, RS485 comm. output
		4	CT input, digital input (DI-1/2), alarm output 1/2/3/4, RS485 comm. output
	4CH	N	CT input, RS485 comm. output
④ Power supply	2	24VDC	
⑤ Control output	R	Relay output	
	C	Selectable current or SSR drive output	
⑥ Module type	B	Basic module	
	E	Expansion module <sup>※1</sup>	

※1. Since the expansion module is not supplied with power/comm. terminal. Order it with the basic module.

### 1.3.2 TMHAIEICTIC [option module]

Type	Model	Input	Output
Analog input/output	TMHA-42AE	Temperature sensor/ Analog input 1 to 4	Transmission output (0/4-20mA) 1 to 4
Digital input, alarm output	TMHE-82RE	Digital input 1 to 8	Alarm output 1 to 8
CT input	TMHCT-82NE	CT input 1 to 8	-
RS422/RS485 communication output	TMHC-22SE	-	COM1, COM2 output

## 1.4 Unit description and function

### 1.4.1 TMH2/4 Series [control module]

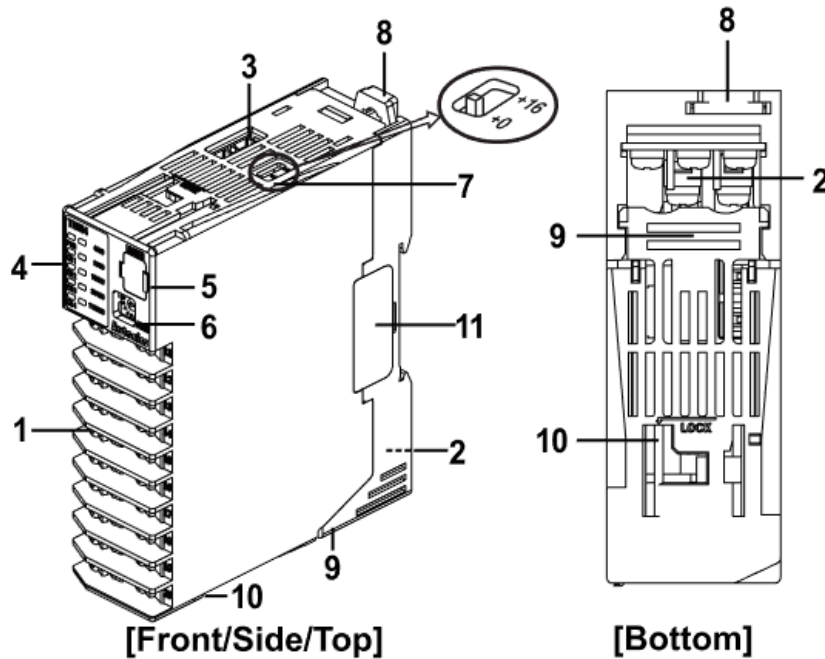

#### 1. Input/Output terminal

For specific information about terminal formation, please refer to '3 Connections and Insulation Block Diagram'.

#### 2. Power/Comm. terminal [basic module only]

Supplies power to both basic control/expansion module and communicates with one or more module.

#### 3. CT input terminal

When using the CT input terminal, remove the rubber cap and connect CT in the same direction with below image.

Connect CT with CICT4-□(CT connector cable, sold separately).

※ When connecting CT connector and CT input terminal, align the concave part (凹) and the convex part (凸).

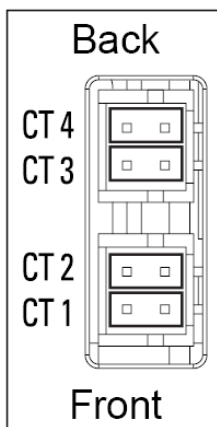

#### 4. Indicator

##### - TMH2 Series

Indicator		Status	Initial power ON <sup>※1</sup>	Control output	Auto tuning <sup>※2</sup>	Alarm output			
						N.O. (Normally Open)		N.C. (Normally Closed)	
						OFF (OPEN)	ON (CLOSE)	OFF (CLOSE)	ON (OPEN)
LED 1	LED 2	PWR (green) <sup>※3</sup>	—	ON	ON	—			
PWR	LED 1	CH1 (red)		ON	Flash				
		CH2 (red)		ON	Flash				
CH 1	AL 1	(red)		ON <sup>※4</sup>	OFF				
CH 2	AL 2	(red)		ON <sup>※5</sup>	OFF				
CH 2	AL 2	(yellow)	Flash (4,800bps)	Module comm. status <sup>※6</sup>					
		AL1 (yellow)	Flash (9,600bps)	—	—	OFF	ON	OFF	ON
		AL2 (yellow)	Flash (19,200bps)	—	—	OFF	ON	OFF	ON
		AL3 (yellow)	Flash (38,400bps)	—	—	OFF	ON	OFF	ON
		AL4 (yellow)	Flash (115,200bps)	—	—	OFF	ON	OFF	ON

##### - TMH4 Series

Indicator		Status	Initial power ON <sup>※1</sup>	Control output	Auto tuning <sup>※2</sup>
LED 1	LED 2	PWR (green) <sup>※3</sup>	—	ON	ON
PWR	LED 1	CH1 (red)		ON	Flash
		CH2 (red)		ON	Flash
CH 1		CH3 (red)		ON	Flash
CH 2		CH4 (red)		ON	Flash
CH 2		(yellow)	Flash (4,800bps)	Module comm. status <sup>※6</sup>	
		(yellow)	Flash (9,600bps)	—	—
CH 3		(yellow)	Flash (19,200bps)	—	—
		(yellow)	Flash (38,400bps)	—	—
CH 4		(yellow)	Flash (115,200bps)	—	—

※1: At the moment when power is on, the indicator of set communication speed flashes for 5 sec.

※2: Indicator of the channel, which is in the process of auto-tuning, flashes at 1 sec interval.

※3: When communicating with external device, PWR indicator flashes.

※4: Turns on, when CH1 outputs cooling control in the heating&cooling control method.

※5: Turns on, when CH2 outputs cooling control in the heating&cooling control method.

※6: Displays communication status in control output, auto-tuning or operating RUN mode.

ON: normal / flash: abnormal / OFF: not communicating

**5. PC loader port:** PC loader port supports serial communication between single module and PC. It needs EXT-US (converter cable)+SCM-US (USB/Serial converter, sold separately) for communicating.

**6. Communication address setting switch (SW1):** Set the communication address. If changing the communication address by setting switch, use the flat head driver which is 2mm size or plastic driver. If not, it may cause product damage.

**7. Communication address group switch (SW2):** When setting the communication address over 16, select +16.

**8. Rail lock:** Rail lock helps installing the device to DIN rail or with bolts.

**9. Lock lever:** Lock lever holds module body and base tightly.

**10. Module lock connector hole:** When connect modules, insert module lock connector in the hole in order to enhance coherence between modules.

**11. END cover:** When connect modules, remove END cover in order to connect expansion connector.

1.4.2 **TMHA/E/CTIC [option module]**

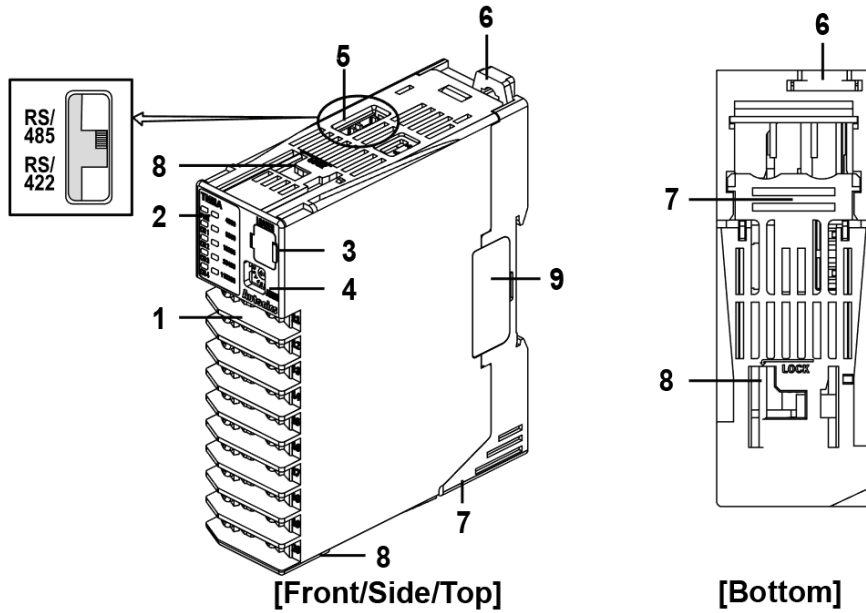

**1. Input/Output terminal**

For specific information about terminal formation, please refer to '3 Connections and Insulation Block Diagram'.

**2. Indicator**

**- TMHA [analog input/output module]**

Indicator		Status	Initial power ON <sup>*1</sup>	Internal comm.	Transmission output
LED 1	LED 2	PWR (green) <sup>*2</sup>	—	ON	ON
PWR CH 1 CH 2 CH 3 CH 4	LED 1	CH1 (red)	—	—	ON
		CH2 (red)	—	—	ON
		CH3 (red)	—	—	ON
		CH4 (red)	—	—	ON
CH 2 CH 3 CH 4	LED 2	(yellow)	Flash (4,800bps)	Module comm. status <sup>*3</sup>	
		(yellow)	Flash (9,600bps)	ON (CH1)	—
		(yellow)	Flash (19,200bps)	ON (CH2)	—
		(yellow)	Flash (38,400bps)	ON (CH3)	—
		(yellow)	Flash (115,200bps)	ON (CH4)	—

**- TMHE [digital input, alarm output module]**

Indicator		Status	Initial power ON <sup>*1</sup>	Internal comm.	Alarm output			
					N.O.(Normally Open)		N.C. (Normally Closed)	
					OFF (OPEN)	ON (CLOSE)	OFF (CLOSE)	ON (OPEN)
LED 1	LED 2	PWR (green) <sup>*2</sup>	—	ON	ON			
PWR AL 1 AL 2 AL 3 AL 4	LED 1	CH1 (red)	—	—	OFF	ON	OFF	ON
		CH2 (red)	—	—	OFF	ON	OFF	ON
		CH3 (red)	—	—	OFF	ON	OFF	ON
		CH4 (red)	—	—	OFF	ON	OFF	ON
AL 5 AL 6 AL 7 AL 8	LED 2	(yellow)	Flash (4,800bps)	Module comm. status <sup>*3</sup>				
		AL5 (yellow)	Flash (9,600bps)	—	OFF	ON	OFF	ON
		AL6 (yellow)	Flash (19,200bps)	—	OFF	ON	OFF	ON
		AL7 (yellow)	Flash (38,400bps)	—	OFF	ON	OFF	ON
AL4	AL8	AL8 (yellow)	Flash (115,200bps)	—	OFF	ON	OFF	ON

**-TMHCT [CT input module]**

Indicator		Status	Initial power ON <sup>※1</sup>	CT input <sup>※4</sup>	Internal comm.
LED 1	LED 2	PWR (green) <sup>※2</sup>	—	ON	ON
PWR	LED 1	(red)		ON (40.1 to 50.0A)	—
		(red)		ON (30.1 to 40.0A)	—
		(red)		ON (20.1 to 30.0A)	—
		(red)		ON (10.1 to 20.0A)	—
	LED 2	(yellow)	Flash (4,800bps)	Module comm. status <sup>※3</sup>	Module comm. status <sup>※3</sup>
		(yellow)	Flash (9,600bps)	ON (40.1 to 50.0A)	—
		(yellow)	Flash (19,200bps)	ON (30.1 to 40.0A)	—
		(yellow)	Flash (38,400bps)	ON (20.1 to 30.0A)	—
		(yellow)	Flash (115,200bps)	ON (10.1 to 20.0A)	—

**-TMHC [RS422/RS485 communication output module]**

Indicator		Status	Initial power ON <sup>※5</sup>	Internal comm.	Connection
LED 1	LED 2	PWR (green) <sup>※2</sup>	Flash (4,800bps)	—	—
PWR	LED 1	(red)	Flash (9,600bps)	Flash (TMH2/4)	—
		(red)	Flash (19,200bps)	Flash (TMHA)	—
		(red)	Flash (38,400bps)	Flash (TMHE)	—
		(red)	Flash (115,200bps)	Flash (TMHCT)	—
	LED 2	(yellow)	Flash (4,800bps)	—	Module comm. status <sup>※3</sup>
		(yellow)	Flash (9,600bps)	—	ON (TMH2/4)
		(yellow)	Flash (19,200bps)	—	ON (TMHA)
		(yellow)	Flash (38,400bps)	—	ON (TMHE)
		(yellow)	Flash (115,200bps)	—	ON (TMHCT)

※1: At the moment when power is on, the indicator of set communication speed flashes for 5 sec.

※2: When communicating with external device, PWR indicator flashes.

※3: Displays internal communication status between modules.

ON: normal / flash: abnormal / OFF: not communicating

※4: The indicator corresponding to the certain set value of CT input flashes according to the parameter [CT Input Value Indication Lamp □].

LED 1: CT Input Value Indication Lamp1 / LED 2: CT Input Value Indication Lamp2

※5: At the moment when power is on, the indicator corresponding to host communication speed flashes for 5 sec. LED 1: host 1 / LED 2: host 2

**3. PC loader port:** PC loader port supports serial communication between single module and PC. It needs EXT-US (converter cable)+SCM-US (USB/Serial converter, sold separately) for communicating.

**4. Communication address setting switch (SW1):** Set the communication address. If changing the communication address by setting switch, use the flat head driver which is 2mm size or plastic driver. If not, it may cause product damage.

**5. Communication mode switch (SW2):** Select communication mode between RS485 and RS422. (TMHC only)

**6. Rail lock:** Rail lock helps installing the device to DIN rail or with bolts.

**7. Lock lever:** Lock lever holds module body and base tightly.

**8. Module lock connector hole:** When connect modules, insert module lock connector in the hole in order to enhance coherence between modules.

**9. END cover:** When connect modules, remove END cover in order to connect expansion connector.





## 2 Specifications

### 2.1 TMH2/4 Series [control module]

Type	Control module	
Series	<b>TMH2</b>	<b>TMH4</b>
No. of channels	2 channels	4 channels
Power supply	24VDC ≐	
Permissible voltage range	90 to 110% of rated voltage	
Power consumption	Max. 5W (for max. load)	
Display method	None- parameter setting and monitoring is available at external devices (PC, PLC, etc.)	
Input type	TC	K(CA), J(IC), E(CR), T(CC), B(PR), R(PR), S(PR), N(NN), C(TT), G(TT), L(IC), U(CC), Platinel II
	RTD	DPT100Ω, JPt100Ω, DPT50Ω, Cu100Ω, Cu50Ω, Nickel 120Ω 3-wire type (permissible line resistance max. 5Ω)
	Analog	<ul style="list-style-type: none"> <li>Voltage: 0-100mVDC≐, 0-5VDC≐, 1-5VDC≐, 0-10VDC≐</li> <li>Current: 0-20mA, 4-20mA</li> </ul>
Sampling cycle	50ms (2CH or 4CH synchronous sampling)	
Measured accuracy	TC	• At room temperature (23°C±5°C): (PV ±0.3% or ±1°C, higher one) ±1-digit*2
	RTD	• Out of room temperature range: (PV ±0.5% or ±2°C, higher one) ±1-digit
	Analog	<ul style="list-style-type: none"> <li>At room temperature (23°C±5°C): ±0.3% F.S. ±1-digit</li> <li>Out of room temperature range: ±0.5% F.S. ±1-digit</li> </ul>
Option input	CT input	0.0-50.0A (primary current measurement range) ※CT ratio=1/1000 Measured accuracy: ±5% F.S. ±1-digit
	Digital input	<ul style="list-style-type: none"> <li>Connect input: ON - max. 1kΩ, OFF - min. 100kΩ</li> <li>Solid-state input: ON - max. residual voltage 0.9V, OFF - max. leakage current 0.5mA</li> <li>Outflow current : approx. 0.3mA per input</li> </ul>
Control method	Heating, Cooling	ON/OFF control, P, PI, PD, PID control
	Heating& Cooling	
Control output	Relay	250VAC 3A 1a
	SSR	Max. 12VDC ±3V 20mA
	Current	Selectable DC 4-20mA or DC 0-20mA (load resistance max. 500Ω)
Option output	Alarm	250VAC 3A 1a
Communication	Master	RS485 communication output (Modbus RTU)
	PC loader	Serial (TTL Level), half duplex

Hysteresis		RTD/Thermocouples: 1 to 100°C/°F (0.1 to 100.0°C/°F), analog: 1 to 100 digit	
Proportional band (P)		RTD/Thermocouples: 1 to 999°C/°F (0.1 to 999.9°C/°F), analog: 0.1 to 999.9 digit	
Integral time (I)		0 to 9999 sec	
Derivative time (D)		0 to 9999 sec	
Control period (T)		Relay output: 0.1 to 120.0 sec, SSR output: 1.0 to 120.0 sec	
Manual reset		0 to 100% (0.0 to 100.0%)	
Relay life cycle	Mechanical	Min. 10,000,000 operations	
	Electrical	Min. 100,000 operations (250VAC 3A resistance load)	
Memory retention		Approx. 10 years (non-volatile semiconductor memory type)	
Insulation resistance		100MΩ (at 500VDC megger)	
Insulation type		Double insulation or reinforced insulation (mark: □, dielectric strength between the measuring input part and the power part: 1kV)	
Dielectric strength		1,000VAC 50/60Hz for 1 min (between input terminals and power terminals)	
Vibration		0.75mm amplitude at frequency of 5 to 55Hz (for 1 min) in each X, Y, Z direction for 2 hours	
Noise immunity		±0.5kV the square wave noise (pulse width: 1 μs) by the noise simulator	
Environment	Ambient temp.	-10 to 50°C, storage: -20 to 60°C	
	Ambient humi.	35 to 85%RH, storage: 35 to 85%RH	
Protection structure		IP20 (IEC standard)	
Accessories		Expansion connector: 1, module lock connector: 2	
Weight <sup>※3</sup>	Basic module	Approx. 250.8g (approx. 177.7g)	Approx. 250.4g (approx. 177.3g)
	Expansion module	Approx. 245.7g (approx. 172.6g)	Approx. 245.1g (approx. 172.2g)

※1: Connecting 1 or more expansion module can vary measurement accuracy about ±1°C, regardless of the number of connected expansion module.

※2: At room temperature (23°C±5°C)

- Thermocouple K, J, N, E below -100°C, L, U, PLII and RTD Cu50Ω, DPt50Ω : (PV ±0.3% or ±2°C, higher one) ±1-digit
- Thermocouple C, G and R, S below 200°C: (PV ±0.3% or ±3°C, higher one) ±1-digit
- Thermocouple B below 400°C: there is no accuracy standards.

Out of room temperature range

- RTD Cu50Ω, DPt50Ω: (PV ±0.5% or ±3°C, higher one) ±1-digit
- Thermocouple R, S, B, C, G: (PV ±0.5% or ±5°C, higher one) ±1-digit
- Others blow -100°C: within ±5°C

※3: The weight includes packaging. The weight in parenthesis is for unit only.

※Environment resistance is rated at no freezing or condensation.

## 2.2 **TMHAIE/CTIC [option module]**

Type	Option module					
Model	<b>TMHA-42AE</b>		<b>TMHE-82RE</b>	<b>TMHCT-82NE</b>	<b>TMHC-22SE</b>	
No. of channels	4 channels		8 points	8 points	COM1, COM2	
Power supply <sup>※1</sup>	24VDC					
Permissible voltage range	90 to 110% of rated voltage					
Power consumption	Max. 5W (for max. load)					
Display method	None- parameter setting and monitoring is available at external devices (PC, PLC, etc.)					
Input type	TC	RTD	Analog	Digital	CT	-
Sampling cycle	50ms (4CH synchronous sampling)			-		
Measured accuracy <sup>※2</sup>	<ul style="list-style-type: none"> <li>• At room temperature (23°C±5°C): (PV ±0.3% or ±1°C, higher one) ±1-digit<sup>※3</sup></li> <li>• Out of room temperature range: (PV ±0.5% or ±2°C, higher one) ±1-digit</li> </ul>		<ul style="list-style-type: none"> <li>• At room temperature (23°C±5°C): ±0.3% F.S. ±1-digit</li> <li>• Out of room temperature range: ±0.5% F.S. ±1-digit</li> </ul>	-		±5% F.S. ±1-digit
Output	Alarm	-		250VAC 3A 1a	-	-
	Transmission	DC 4-20mA or DC 0-20mA (load resistance max. 500Ω)		-		
Communication	Master	RS485 communication output (Modbus RTU)		RS485/RS422 (Modbus RTU)		
	PC loader	Serial (TTL Level), half duplex				
Relay life cycle	Mechanical	-		Min. 10,000,000 operations	-	
	Electrical	-		Min. 100,000 operations (250VAC 3A resistance load)	-	
Memory retention	Approx. 10 years (non-volatile semiconductor memory type)					
Insulation resistance	Over 100MΩ (500VDC megger)					
Insulation type	Double insulation or reinforced insulation (mark:☐, dielectric strength between the			-		

	measuring input part and the power part : 1kV)			
Dielectric strength	1,000VAC 50/60Hz for 1 min (between power source terminal and input terminal)			
Vibration	0.75mm amplitude at frequency of 5 to 55Hz (for 1 min) in each X, Y, Z direction for 2 hours			
Noise immunity	Square shaped noise by noise simulator (pulse width 1 $\mu$ s) $\pm$ 0.5kV R-phase, S-phase			
Environment	Ambient temp.	-10 to 50°C, storage: -20 to 60°C		
	Ambient humi.	35 to 85%RH, storage: 35 to 85%RH		
Protection structure	IP20 (IEC standard)			
Accessories	Expansion connector: 1, module lock connector: 2			
Weight※4	Approx. 233.8g (approx. 160.7g)	Approx. 239g (approx. 165.9g)	Approx. 220.6g (approx. 147.5g)	Approx. 222.1g (approx. 149.0g)

※1: Voltage of power supply/communication terminal placed in the backside of TMH2/4 Series (basic control module)

※2: Input type

TMHA	Thermocouple	K(CA), J(IC), E(CR), T(CC), B(PR), R(PR), S(PR), N(NN), C(TT), G(TT), L(IC), U(CC), Platinel II
	RTD	DPt100 $\Omega$ , JPt100 $\Omega$ , DPt50 $\Omega$ , Cu100 $\Omega$ , Cu50 $\Omega$ , Nikel 120 $\Omega$ 3-wire type (permissible line resistance max. 5 $\Omega$ per line)
	Analog	<ul style="list-style-type: none"> <li>Voltage: 0-100mVDC, 0-5VDC, 1-5VDC, 0-10VDC</li> <li>Current: 0-20mA, 4-20mA</li> </ul>
TMHE	Digital	<ul style="list-style-type: none"> <li>Connect input: ON - max. 1k<math>\Omega</math>, OFF - min. 100k<math>\Omega</math></li> <li>Solid-state input: ON - max. residual voltage 0.9V, OFF - max. leakage current 0.5mA</li> <li>Outflow current: approx. 0.3mA per input</li> </ul>
TMHCT	CT	0.0-50.0A (primary current measurement range) ※CT ratio=1/1000

※3: In case of TMHA, connecting 1 or more expansion module can vary measurement accuracy about  $\pm$ 1°C, regardless of the number of connected expansion module.

※4: At room temperature (23°C $\pm$ 5°C)

- Thermocouple K, J, N, E below -100°C, L, U, PLII and RTD Cu50 $\Omega$ , DPt50 $\Omega$ :  
(PV  $\pm$ 0.3% or  $\pm$ 2°C, higher one)  $\pm$ 1-digit
- Thermocouple C, G and S below 200°C: (PV  $\pm$ 0.3% or  $\pm$ 3°C, higher one)  $\pm$ 1-digit
- Thermocouple B below 400°C: there is no accuracy standards.  
Out of room temperature range
- RTD Cu50 $\Omega$ , DPt50 $\Omega$ : (PV  $\pm$ 0.5% or  $\pm$ 3°C, higher one)  $\pm$ 1-digit
- Thermocouple R, S, B, C, G: (PV  $\pm$ 0.5% or  $\pm$ 5°C, higher one)  $\pm$ 1-digit
- Others blow -100°C: within  $\pm$ 5°C

※5: The weight includes packaging. The weight in parenthesis is for unit only.

※Environment resistance is rated at no freezing or condensation.



### 3 Connections and Insulation Block Diagram

#### 3.1 Connections by Series

##### 3.1.1 TMH2 Series [2 channels, control module]

- Power/Comm. terminal on the back [basic module only]

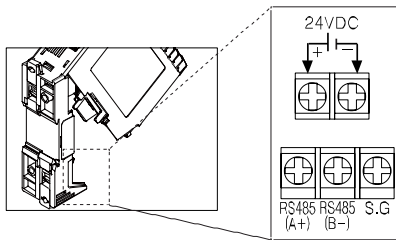

- Input/Output terminal on the front

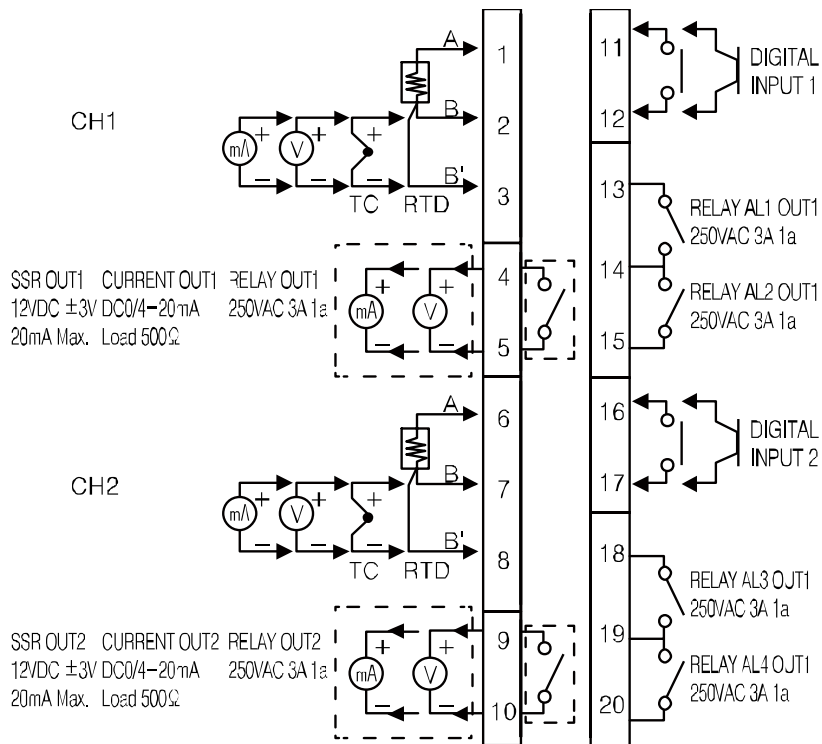

- CT input terminal on the top  
When use the CT input terminals, remove the robber cap.  
Connect CT with CICT4-□ (CT connector cable, sold separately).

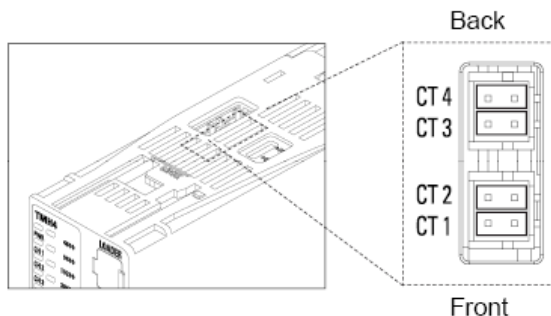

### 3.1.2 TMH4 Series [4 channels, control module]

- Power/Comm. terminal on the back [basic module only]

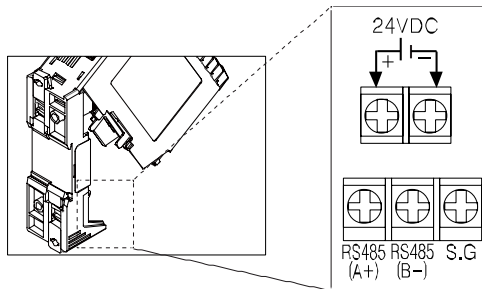

- Input/Output terminal on the front

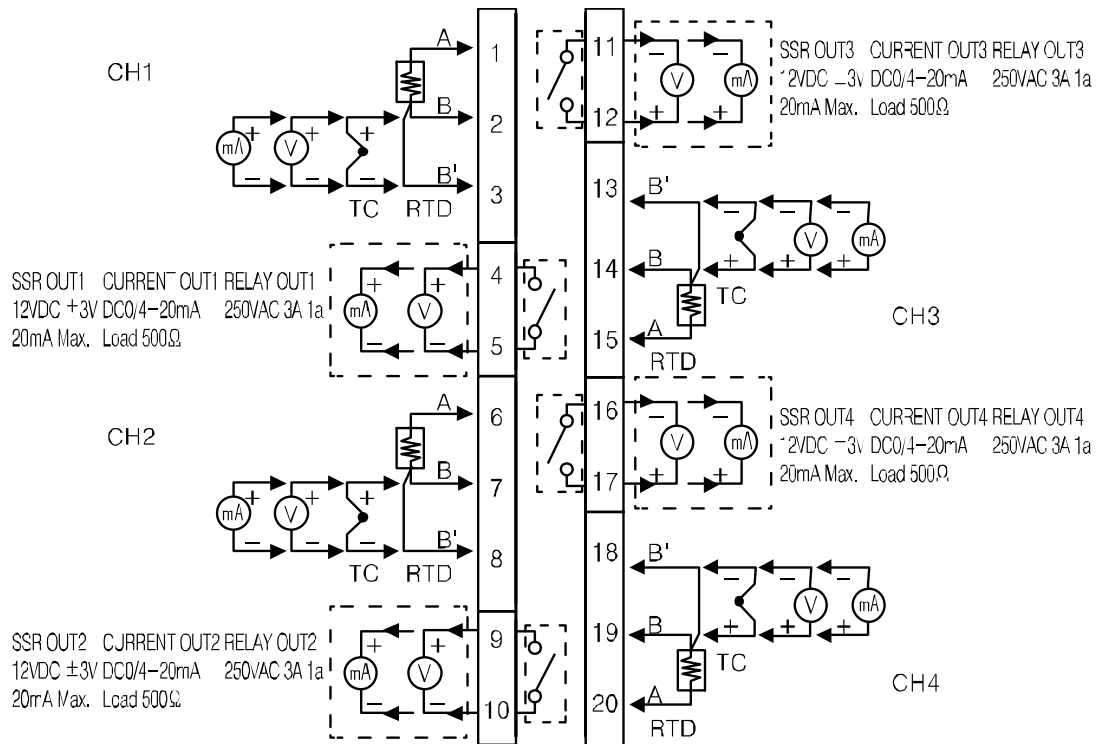

- CT input terminal on the top  
When use the CT input terminals, remove the robber cap.  
Connect CT with CICT4-□ (CT connector cable, sold separately).

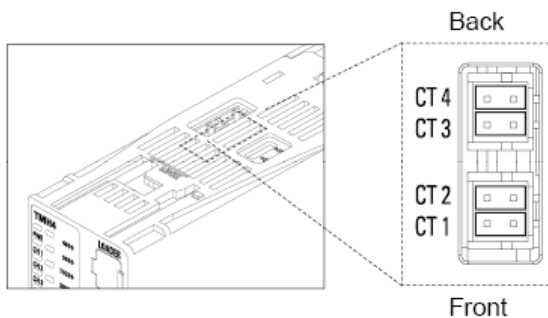



### 3.1.3 TMHA [analog input/output module]

- Input/Output terminal on the front

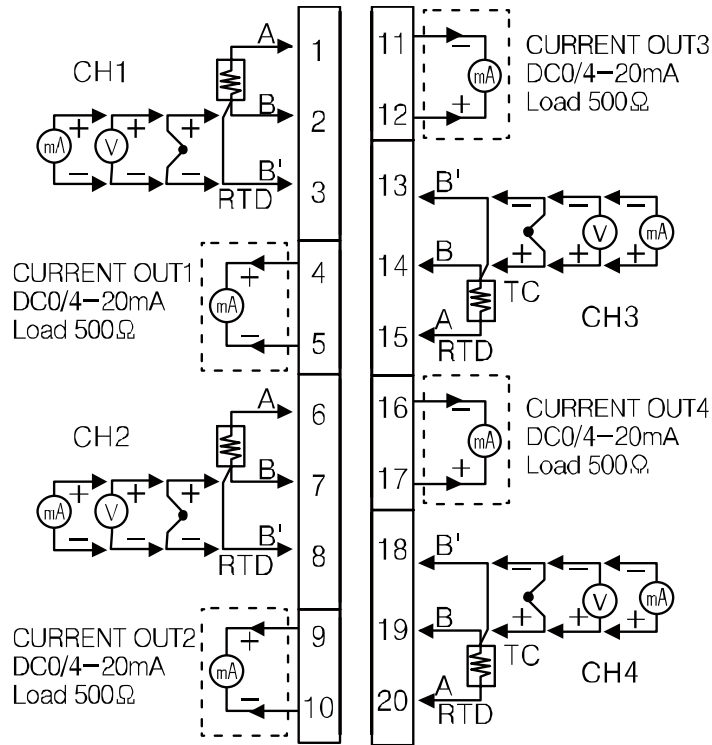

### 3.1.4 TMHE [digital input/alarm output module]

- Input/Output terminal on the front

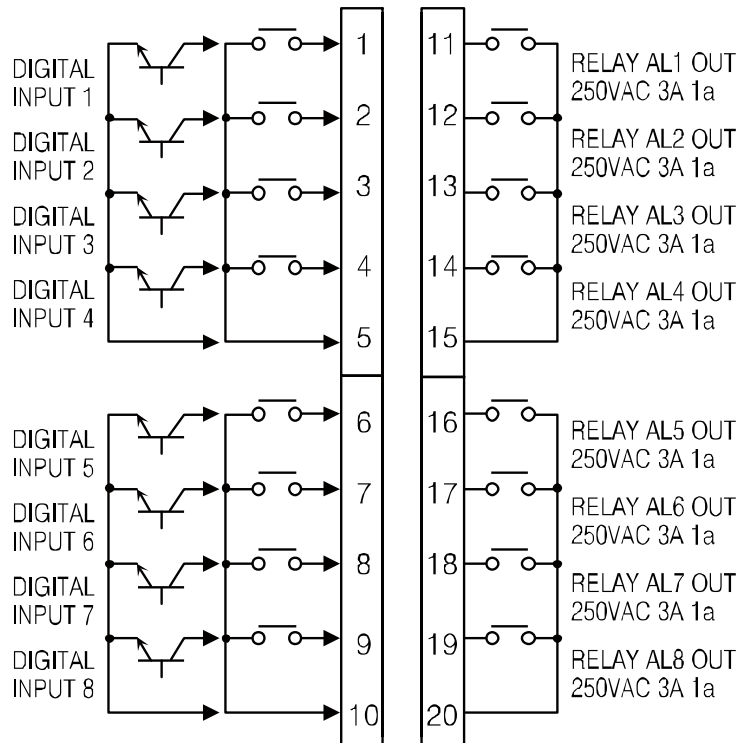

**3.1.5 TMHCT [CT input module]**

- Input/Output terminal on the front

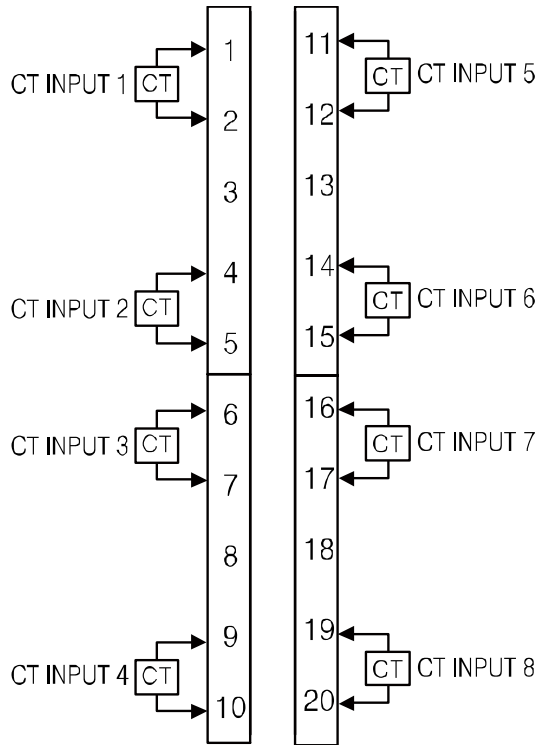

**3.1.6 TMHC [RS422/RS485 comm. output module]**

- Input/Output terminal on the front

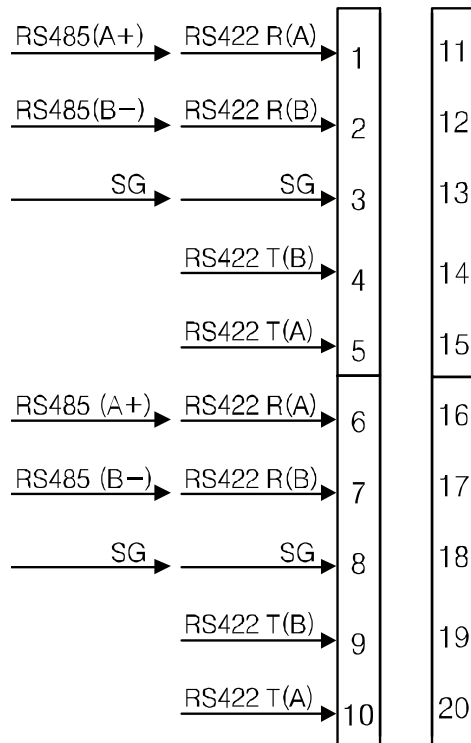

## 3.2 Caution for connection

### (1) Common

- Check 'Connections' before wiring.
- Do not connect the not-used terminals.
- Keep metal chip, dust, and wire residue from flowing into the unit.
- Use terminals of size specified below.

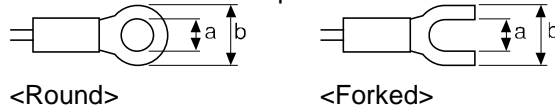

	a	B
Round	Min. 3.0mm	Max. 5.8mm
Forked	Min. 3.0mm	Max. 5.8mm

- Do not connect input cable and power cable together.
- Do not connect communication cable and power cable together.
- Keep away from high voltage lines or power lines to prevent inductive noise. In case installing power line and input signal line closely, use line filter or varistor at power line and shielded wire at input signal line. Do not use near the equipment which generates strong magnetic force or high frequency noise.

### (2) Power

- Check the polarity of the power terminal.
- When connecting the power input and relay output, use AWG 20(0.50mm<sup>2</sup>) cable or over and tighten the terminal screw with a tightening torque of 0.74 to 0.90N·m.
- Supply adequate power for power input specifications and overall capacity. (Max. power when connecting 32 modules: 32×5W=160W)
- Power supply should be insulated and limited voltage/current or Class 2, SELV power supply device.

### (3) Input

- Use the dedicated sensor of the TMH Series.
- When connecting the sensor input and communication cable without dedicated cable, use AWG 28 to 16 cable and tighten the terminal screw with a tightening torque of 0.74 to 0.90N·m.
- Check the polarity of the terminals before wiring the temperature sensor. For RTD temperature sensor, wire it as 3-wire type, using cables in same thickness and length. For thermocouple (CT) temperature sensor, use the designated compensation wire for extending wire.
- For thermocouple sensors, use compensation wire of the same specification as input sensors. Using an extension wire of different specification and/or material will increase inaccuracy of temperature sensing. It is recommended to choose high performance compensation wire for more reliable sensing.
- Make sure the sensor is securely attached to the input connector.
- Carefully adjust both load and sensor positions.

### (4) Output

- Make sure to connect rated SSRs or loads to the output terminals.
- When connecting the relay output terminal, use over AWG 20(0.50mm<sup>2</sup>) cable or over and tighten the terminal screw with a tightening torque of 0.74 to 0.90N·m.

**(5) Communication**

- Make sure to communication A, B terminal direction.
- In case of not dedicated communication line, use AWG 28 to 16 cable and tighten the terminal screw with a tightening torque of 0.74 to 0.90N·m.
- Use twisted pair wire for communication line and connect ferrite bead at each end of line to reduce the effect of external noise.
- Do not allow the communication line to exceed 800m in length.

## 4 Dimensions

•Rail Lock position:  
mounting with bolts

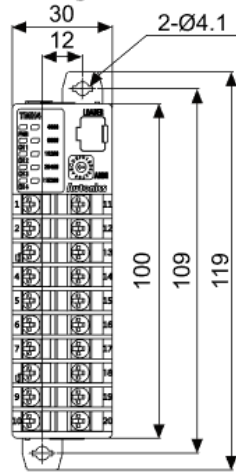

•Rail Lock position:  
mounting on DIN rail

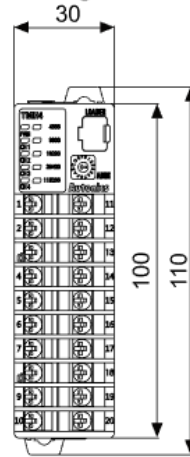

(unit: mm)

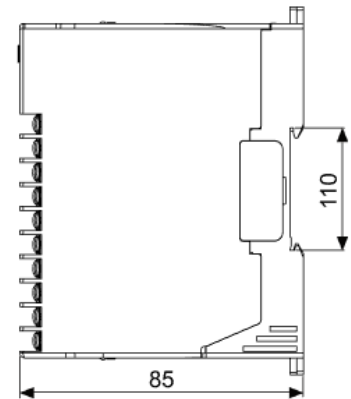

### Note

Only basic module of control module has power/communication terminal.

### 4.1 Installation

#### (1) Separating base terminal block

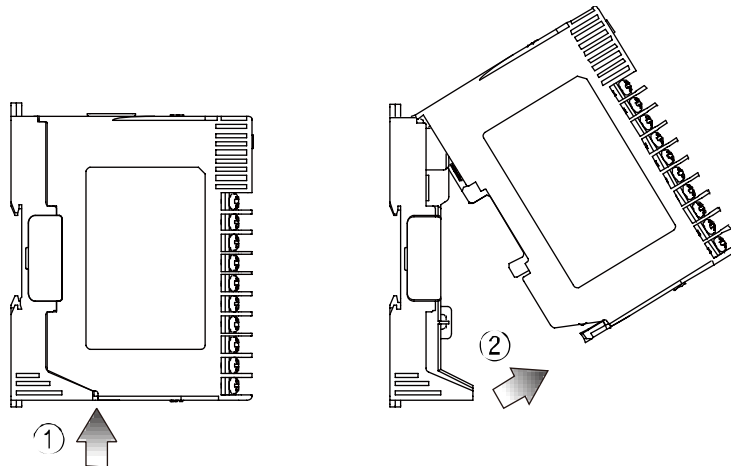

- ① Push the lock lever at the bottom of the module.
- ② Pull the body of the module and open up.



### Note

When connecting base terminal block, align the upper concave part (□) of the body and the upper convex part (▣) of the base. If the upper parts are not align correctly, it may damage to the inner connector.

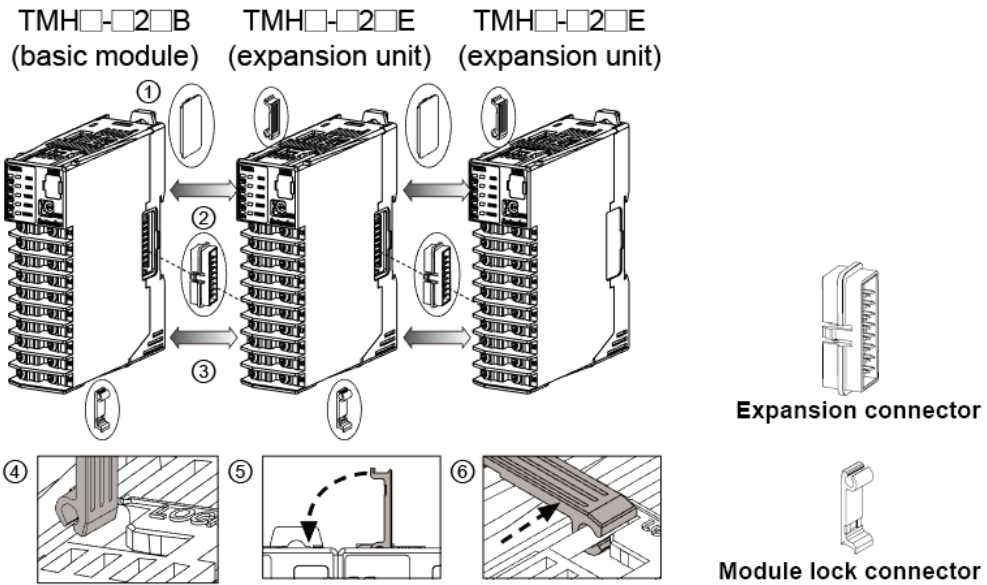
**(2) Connection between modules**

- ① Remove END cover of each module (except END cover of the first and last module).
- ② Insert expansion connector.
- ③ Put all together tightly (max. 31 units).
- ④ Insert module lock connector.
- ⑤ Push module lock connector and insert in lock connector hole of another module on the side.
- ⑥ Push module lock connector to the lock direction.

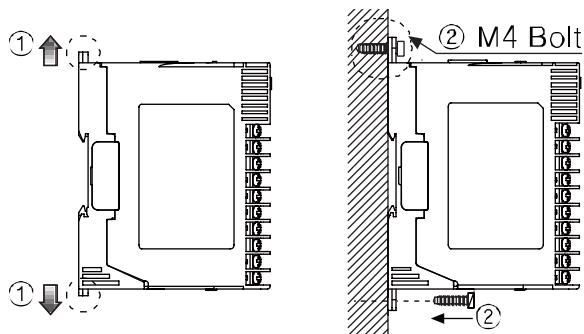
**(3) Mounting with bolts**

- ① Pull the rail lock at the top and bottom of the module.
- ② Insert bolts and fix it on rail lock.(fixing torque is 0.5 to 0.9N.m.)

**(4) Mounting on DIN rail**

- Installing

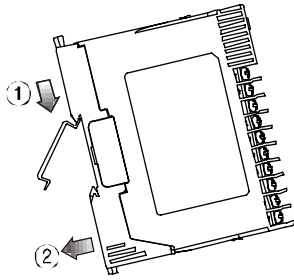

- ① Hang the top rail lock to DIN rail.
- ② Push and press the module to down direction.

- Removing

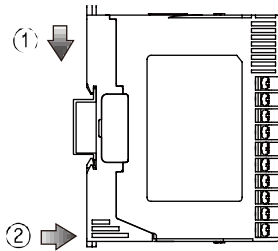

- ① Press the module down.
- ② Pull the module body forward.

**Note**

Install the module vertically.

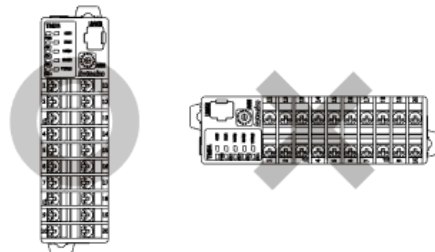

- Use end plates (sold separately, not available from Autonics) to fix firmly.

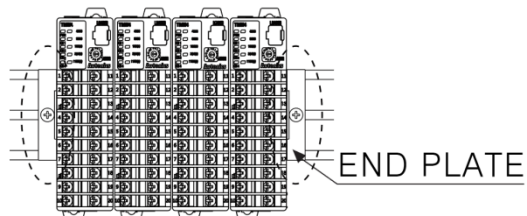





## 5 Preparation and Startup

### 5.1 General process

Before operating TMH Series for the first time, do the following:

- 1st Connect all external devices, sensor and load to the TMH Series.
- 2nd Set parameter values through external connecting devices (PC loader program, GP etc.).
- 3rd Download the parameters to TMH Series.
- 4th Proceed with auto-tuning or set control variables, and then start control.



#### Note

For using comprehensive devicem management program 'DAQMaster, parameters are automatically downloaded at the time when they are changed.

### 5.2 Setup values when power ON

Setting category	Factory default	Previous set value	Power ON set value
Auto/Manual	Auto	Auto	Auto
		Manual	Manual
RUN/STOP	RUN	RUN	RUN
		STOP	STOP
PID/ONOFF	PID	PID	Maintains set value
		ONOFF	Maintains set value
MV	0.0	Preset MV	Maintains set value
	0.0	Stop MV	Maintains set value
	0.0	Sensor Error MV	Maintains set value



## 6 Connection examples

### 6.1 TMH2/4 connection

#### (1) Relay output

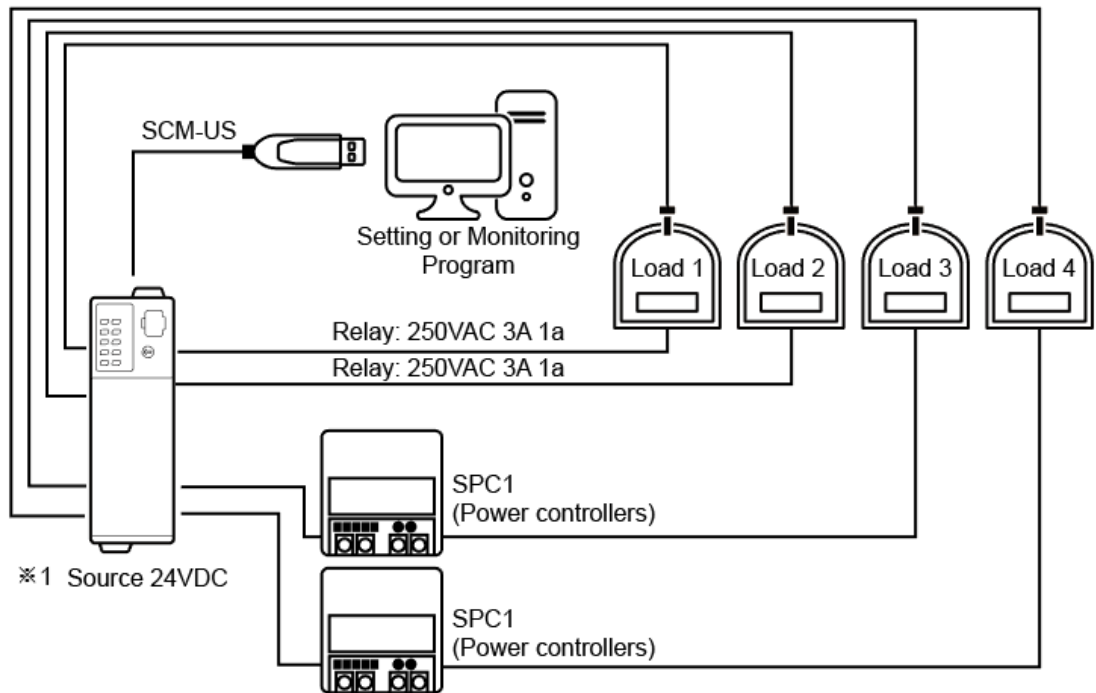

※ 1. Using SCM-US enables only setting parameter. To monitor and control temperature requires the additional 24VDC power supply.

#### Caution

Do not connect SCM-US and RS485 communications cables at the bottom at the same time.

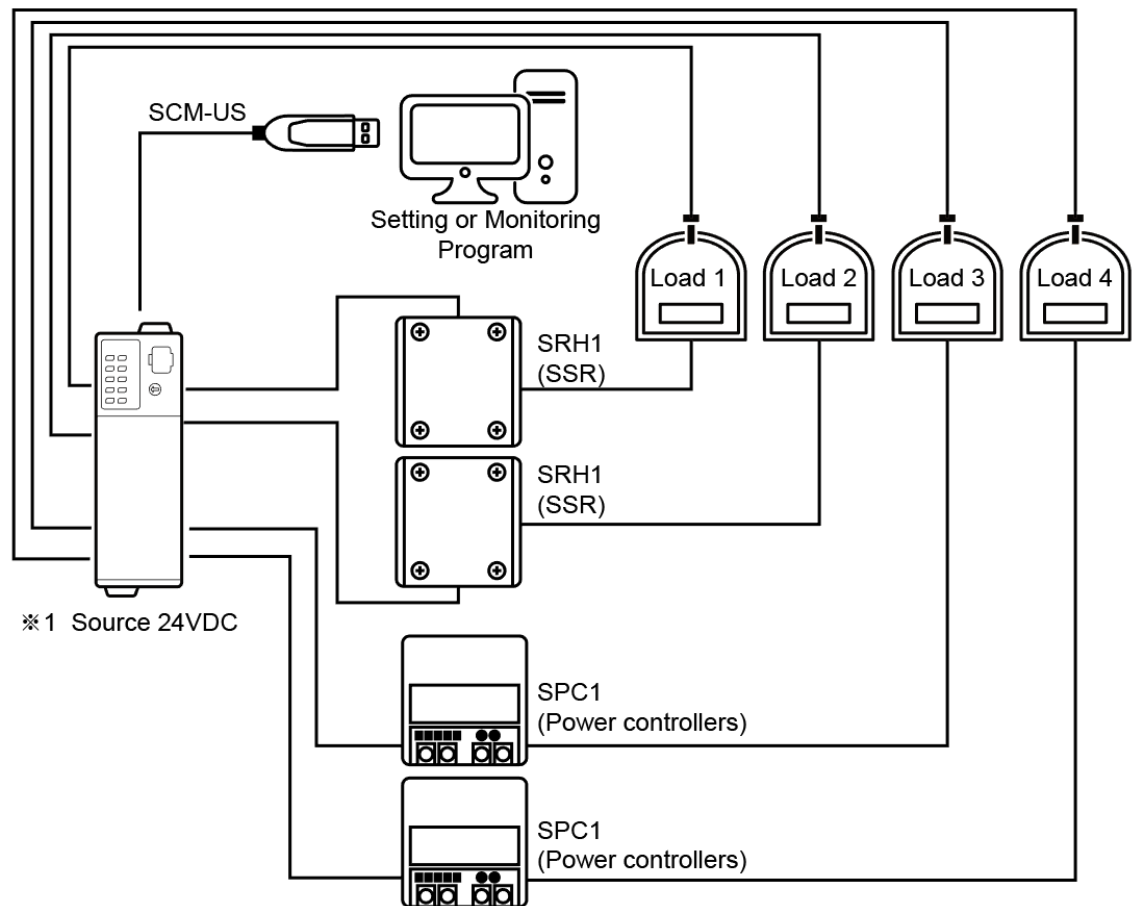
**(2) SSR drive output**

※ 1. Using SCM-US enables only setting parameter. To monitor and control temperature requires the additional 24VDC power supply.

**Caution**

- Do not connect SCM-US and RS485 communications cables at the bottom at the same time.
- Use an isolated type SSR.

## 6.2 **TMH2/4, TMHA, TMHE, TMHCT interworking configuration example**

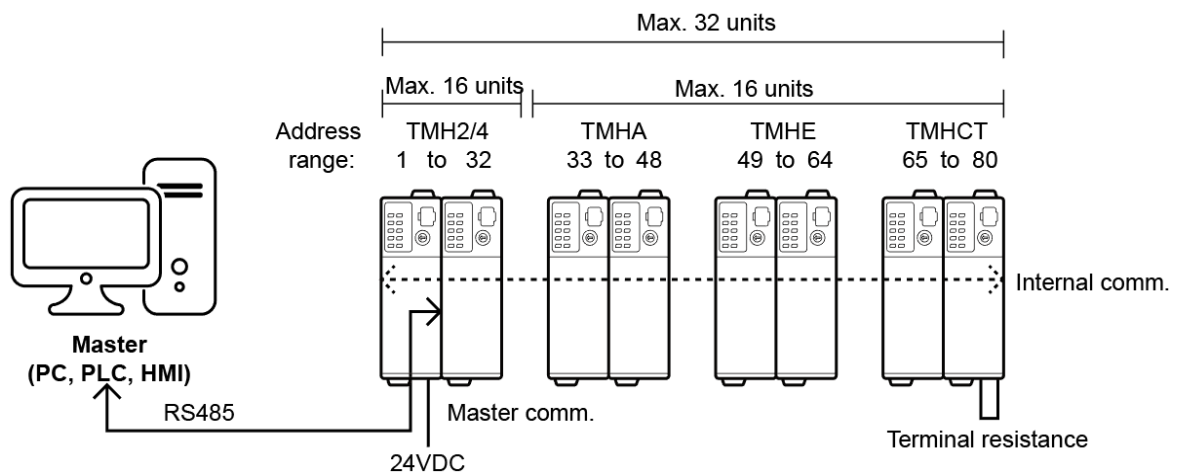

- Internal communication: Receive/Send data between TMH2/4 and TMHA/E/CT
- External communication: Communicate with Master for controlling
- Each module is available to monitoring at DAQMatser via PC loader

### 6.3 TMHC interworking configuration example

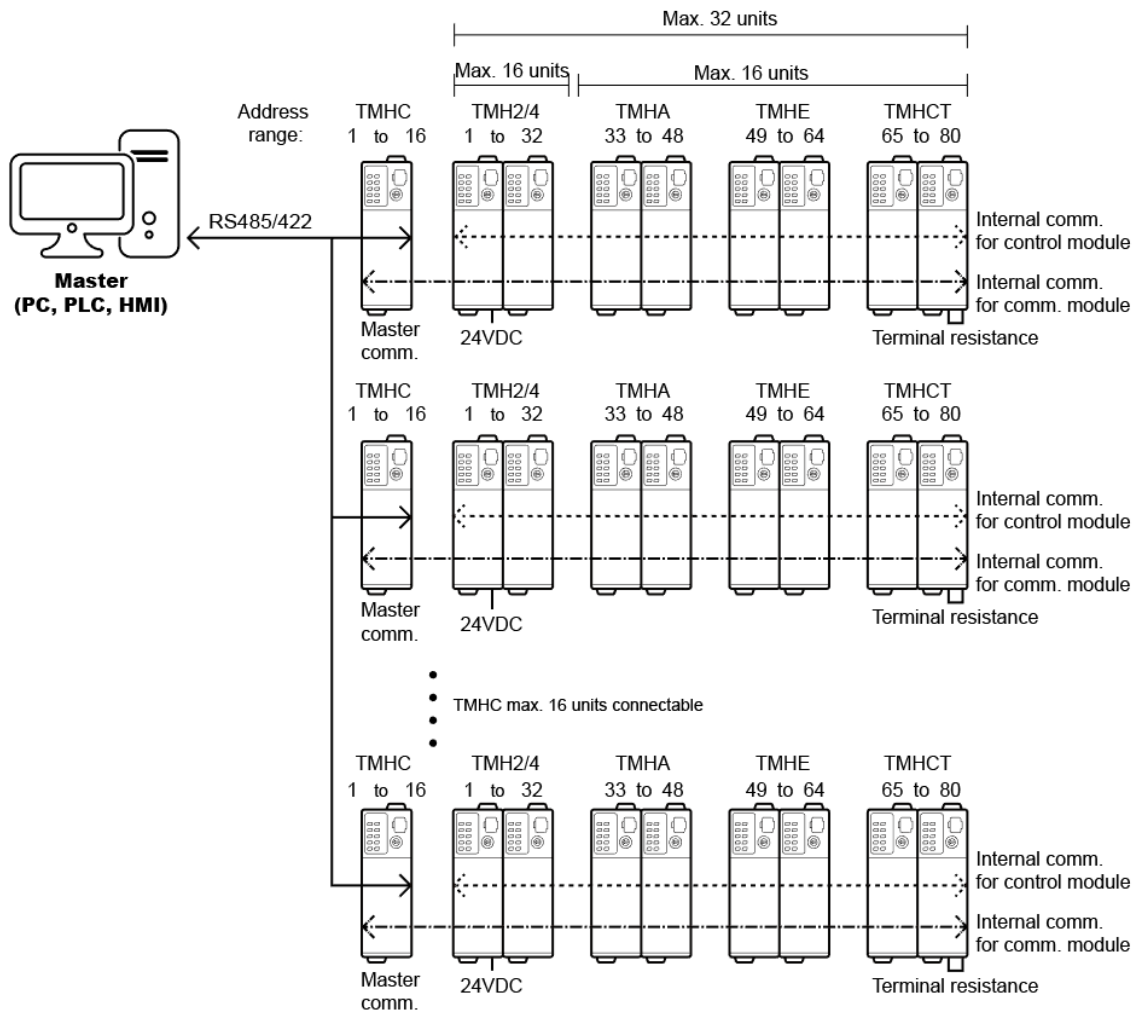

- When using TMHC, in case connecting only TMHC to Master (PC, PLC, etc.), communication address of TMHC and TMH2/4 Series control module can be duplicated. However, in case connecting both TMHC and TMH2/4 Series control module to Master, communication address must not be duplicated. (If the TMHC and TMH modules communicate to Master at the same time, a communication error may occur.)

## 7 Parameter Settings and Functions

### 7.1 Input

#### 7.1.1 Input type and range TMH2/4 TMHA

Input type		Decimal point	Display	Temperature range(°C)	Temperature range (°F)	
Thermocouple	K(CA)	1	K(CA).H	-200 to 1350	-328 to 2463	
		0.1	K(CA).L	-200.0 to 1350.0	-328.0 to 2463.0	
	J(IC)	1	J(IC).H	-200 to 800	-328 to 1472	
		0.1	J(IC).L	-200.0 to 800.0	-328.0 to 1472.0	
	E(CR)	1	E(CR).H	-200 to 800	-328 to 1472	
		0.1	E(CR).L	-200.0 to 800.0	-328.0 to 1472.0	
	T(CC)	1	T(CC).H	-200 to 400	-328 to 752	
		0.1	T(CC).L	-200.0 to 400.0	-328.0 to 752.0	
	B(PR)	1	B(PR)	0 to 1800	32 to 3272	
	R(PR)	1	R(PR)	0 to 1750	32 to 3182	
	S(PR)	1	S(PR)	0 to 1750	32 to 3182	
	N(NN)	1	N(NN)	-200 to 1300	-328 to 2372	
	C(TT)	1	C(TT)	0 to 2300	32 to 4172	
	G(TT)	1	G(TT)	0 to 2300	32 to 4172	
	L(IC)	1	L(IC).H	-200 to 900	-328 to 1652	
0.1		L(IC).L	-200.0 to 900.0	-328.0 to 1652.0		
U(CC)	1	U(CC).H	-200 to 400	-328 to 752		
	0.1	U(CC).L	-200.0 to 400.0	-328.0 to 752.0		
Platinel II	1	PLII	0 to 1390	32 to 2534		
RTD	Cu 50Ω		0.1	CU 50	-200.0 to 200.0	-200.0 to 392.0
	Cu 100Ω		0.1	CU 100	-200.0 to 200.0	-200.0 to 392.0
	JIS standard	JPt 100Ω	1	JPt100.H	-200 to 650	-328 to 1202
		JPt 100Ω	0.1	JPt100.L	-200.0 to 650.0	-328.0 to 1202.0
	DIN standard	DPt 50Ω	0.1	DPt50.L	-200.0 to 600.0	-328.0 to 1202.0
		DPt 100Ω	1	DPt100.H	-200 to 650	-328 to 1202
		DPt 100Ω	0.1	DPt100.L	-200.0 to 650.0	-328.0 to 1202.0
Nickel 120Ω		1	NI12	-80 to 200	-112 to 392	
Analog	Voltage	0 to 10V	-	AV1	0 to 1000	
		0 to 5V	-	AV2	0 to 5000	
		1 to 5V	-	AV3	1000 to 5000	
		0 to 100mV	-	AMV1	0 to 1000	
	Current	0 to 20mA	-	AMA1	0 to 2000	
		4 to 20mA	-	AMA2	400 to 2000	

- Temperature sensors convert subject temperature to electrical signals for the temperature controller, allowing it to control output.
- In case of analog input, even though control target is not temperature (humidity, flow, pressure, level, etc), measured data (analog signal) is input and measuring and controlling are available. When analog signal of control target is out of the operational range, use the additional signal converter to converting.
- SV (set value) can only be set within the input range.

### 7.1.2 **Input type** TMH2/4 TMHA

This product supports multiple input types, making it possible for the user to choose from thermocouples, resistors, and analog voltage/current. Different sensors can be designated to each channel.

Setting group	Parameter	Set range	Factory default	Unit
Initial Setting	Input Type	Refer to 7.1.1 Input type and range <span style="border: 1px solid black; padding: 2px;">TMH2/4</span> <span style="border: 1px solid black; padding: 2px;">TMHA</span>	0: K(CA).H	-



#### Note

- When changing input type settings and input type is temperature sensor, the high/low-limit values of SV are automatically changed to max./min. values of operational temperature range of the modified input type.

When changing input type settings and input type is analog, analog high/low-limit input value are automatically changed to max./min. values of operational range of the modified input type. The high/low-limit values of SV are automatically changed to max./min. values of the modified input type.

- When input type changing is completed, control operation is paused and it returns automatically. The reset parameters are as below.

- TMH2/4

Multi SV No.	Alarm output high/low-limit set value	SV-0 to 3
Heating&Cooling control, dead band	Heating/Cooling, hysteresis	Heating/Cooling, offset
Ramp up/down change rate	Ramp time unit	Analog high/low-limit input value
Analog scale value decimal point position	Analog scale high/low-limit value	Input correction
SV high/low-limit value	Root function low cut point	LBA monitoring time/detection band

- TMHA

Analog high/low-limit input value	Analog scale value decimal point position	Analog scale high/low-limit value
Input correction	Analog transmission output value	Transmission output high/low-limit value



- When input error occurs, display/output is as below.

Item	Measured value < Operational range	Operational range < Measured value	When input is disconnected,
DAQMaster and external devices	LLLL	HHHH	OPEN
Communication output (decimal)	-30000	30000	31000
Indicators	The dedicated channel's status indicators(red LED) flashes in 0.5 sec.		

### 7.1.3 **Sensor temperature unit** TMH2/4 TMHA

In case of temperature sensor input, temperature unit is available to set.

Setting group	Parameter	Set range	Factory default	Unit
Initial Setting	Unit	0: °C, 1: °F	0: °C	-



#### Note

- When changing temperature unit settings, the reset parameters are same as the changing input type setting's.
- When input type is analog, this parameter is not changed.

### 7.1.4 **Analog high/low-limit input value** TMH2/4 TMHA

In case of analog input, it is available to set the operational high/low-limit range within the input type and range(7.1.1 Input type and range TMH2/4 TMHA).

Setting group	Parameter	Set range	Factory default	Unit
Initial Setting	Low-limit Input Value	Min. operational range to high-limit input value (High-limit input value settings) – F.S. 10%	Refer to 7.1.1 Input type and range <span style="border: 1px solid black; padding: 2px;">TMH2/4</span> <span style="border: 1px solid black; padding: 2px;">TMHA</span>	Digit
	High-limit Input Value	Low-limit input value(Low-limit input value settings) + F.S. 10% to Max. operational range		



#### Note

- Analog high/low-limit input value does not display the decimal point.
- High-limit scale value and low-limit scale value are not set the same values.

**7.1.5 Analog scale value decimal point position** TMH2/4 TMHA

In case of analog input, decimal point of PV, SV, etc. is available to set within the high/low-limit scale.

Setting group	Parameter	Set range	Factory default	Unit
Initial Setting	Decimal Point	0:0, 1:0.0, 2:0.00, 3:0.000	0:0	-

**7.1.6 Analog scale highlow-limit value** TMH2/4 TMHA

In case of analog input, display scale for high/low-limit input value is available to set. Depending on analog scale value decimal point position setting, the displayed value is different.

Setting group	Parameter	Set range	Factory default	Unit
Initial Setting	Low-limit Scale Value	-9999 to 9999	0	Digit
	High-limit Scale value		1000	



Ex.

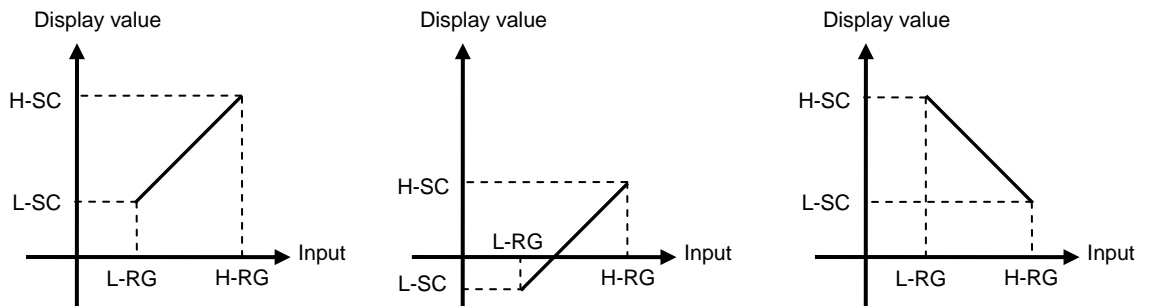

Note

For analog input,  $\pm 5\%$  of the set high/low limit input value is extended. Analog output is also extended comparing input value. (For temperature sensor input,  $\pm 5\%$  extension is applied within the temperature range.)

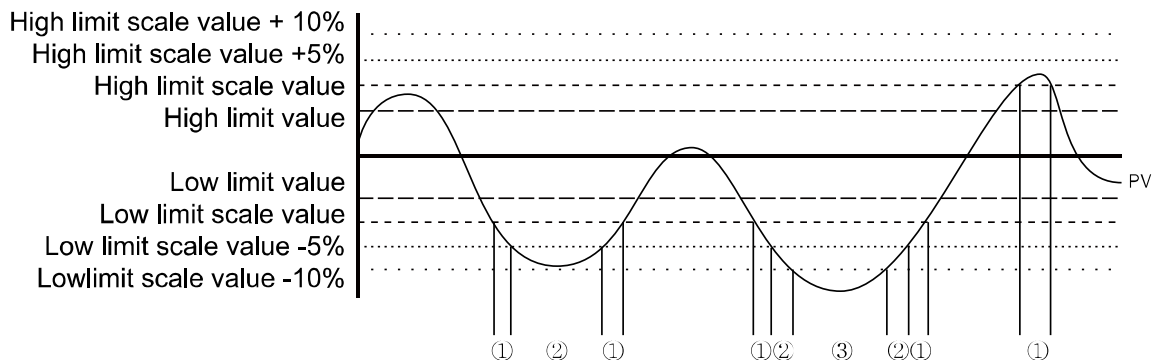

No	PV	Display
①	$\pm 5\%$ section	Flashes PV
②	$\pm 5$ to $10\%$ section	Flashes HHHH or LLLL
③	Over $\pm 10\%$ section	Flashes OPEN

**7.1.7 Analog input special function** TMH2/4 TMHA

In case of analog input, it displays the applied measured value of the set special function.

Setting group	Parameter	Set range	Factory default	Unit
Initial Setting	Input Func	0: LINEAR, 1: ROOT, 2: SQUARE	0: LINEAR	-

**7.1.7.1 Linear**

It applies low-limit scale and high-limit scale to low-limit input value and high-limit input value and displays this values.

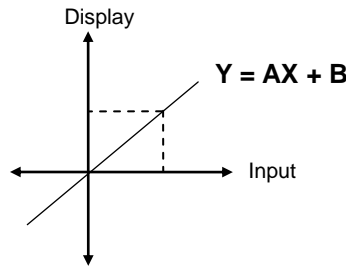

Display value

$$= \frac{\text{Input value} - \text{Low} - \text{limit input value}}{\text{High} - \text{limit input value} - \text{Low} - \text{limit input value}} \times (\text{High} - \text{limit scale value} - \text{Low} - \text{limit scale value}) + \text{Low} - \text{limit scale value}$$



**Ex.**

In case of input type: 0-10V, low-limit input value: 0V, high-limit input value: 10V, low-limit scale: 0, high-limit scale: 1000, present input value is 2V and the display value is 200.

$$200 = \left\{ \frac{2 - 0}{10 - 0} \times (1000 - 0) \right\} + 0$$

**7.1.7.2 Root**

In case of voltage, current (shunt) input, this mode is used when input value is calculated by Root( $\sqrt{\quad}$ ) for the desired display value. Differential pressure signal of differential pressure flow meter is calculated Root( $\sqrt{\quad}$ ) for the to-be measured flux. This function is used to measure flux by input value.

When the differential pressure flow meter is calculated and output as Root( $\sqrt{\quad}$ ) value, please select the Linear function.

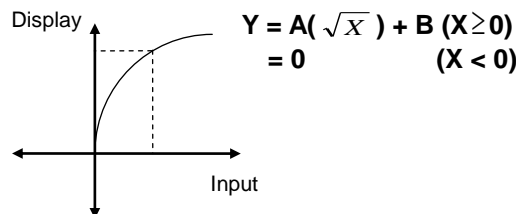

Display value

$$= \sqrt{\frac{\text{Input value} - \text{Low} - \text{limit input value}}{\text{High} - \text{limit input value} - \text{Low} - \text{limit input value}}} \times (\text{High} - \text{limit scale value} - \text{Low} - \text{limit scale value}) + \text{Low} - \text{limit scale value}$$

**Ex.**

In case of input type: 0-10V, low-limit input value: 0V, high-limit input value: 10V,  
low-limit scale: 0, high-limit scale: 1000, present input value is 2V and the display value is 447.

$$447 = \left\{ \sqrt{\frac{2-0}{10-0}} \times (1000-0) \right\} + 0$$

### 7.1.7.3 Square

In case of voltage, current (shunt) input, this mode is used when input value is calculated by square for the desired display value.

Reverse of Root, flux signal is calculated by square for differential pressure signal.

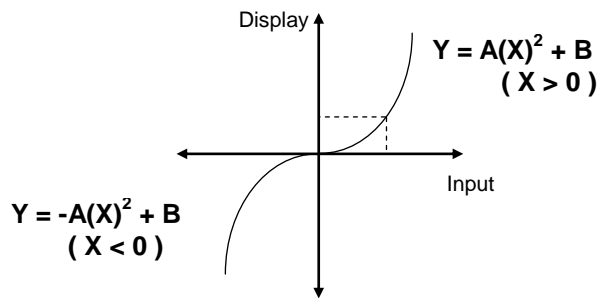

Display value

$$= \left( \frac{\text{input value} - \text{low} - \text{limit input value}}{\text{high} - \text{limit input value} - \text{low} - \text{limit input value}} \right)^2 \times (\text{high} - \text{limit scale} - \text{low} - \text{limit scale}) + \text{low} - \text{limit scale}$$

**Ex.**

In case of input type: 0-10V, low-limit input value: 0V, high-limit input value: 10V,  
low-limit scale: 0, high-limit scale: 1000, present input value is 2V and the display value is 40.

$$40 = \left\{ \left( \frac{2-0}{10-0} \right)^2 \times (1000-0) \right\} + 0$$

### 7.1.7.4 Root function low cut point

When analog input special function is Root, Root function is available to set low cut point.

In case of square root calculation such as flow control, and low input value, the calculation result value may be different. For reducing control error due to input variance, set the low cut point to cut out the lower input than the low cut point. (low cut is applied after square root calculation)

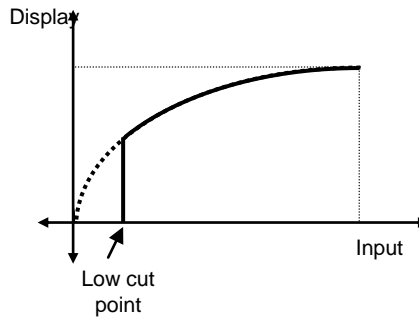

Setting group	Parameter	Set range	Factory default	Unit
Initial Setting	Root Low Cut	-9999 to 9999	0	Digit

### 7.1.8 Input correction TMH2/4 TMHA

This feature is used to compensate for input correction produced by thermocouples, RTDs, or analog input devices, NOT by the controller itself.

The Input correction function is mainly used when the sensor cannot be attached directly to controlled objects. It is also used to compensate for temperature variance between the sensor's installation point and the actual measuring point.

Setting group	Parameter	Set range	Factory default	Unit	
Initial Setting	Input Bias	Temperature H, analog	-999 to 999	0	Temperature: °C/°F, Analog: Digit
		Temperature L	-9999 to 9999 (-999.9 to 999.9)		



Ex.

If the controller displays 78°C when the actual temperature is 80°C, set the input correction 2, in order to adjust the controller's display temperature to 80°C.



Note

- Make sure that an accurate temperature variance measurement is taken before set values of input correction. An inaccurate initial measurement can lead to greater variance.
- Many of today's temperature sensors are graded by their sensitivity. Since higher accuracy usually comes at a higher cost, most people tend to choose sensors with medium sensitivity. Measuring each sensor's sensitivity correction for input correction feature in order to ensure higher accuracy in temperature reading.
- When present temperature value (PV) is out of operational range of the input type after input correction, it outputs 30000(HHHH), -30000(LLLL) and DAQMaster and external devices displays 'HHHH' or 'LLLL'.

### 7.1.9 **Input digital filter** TMH2/4 TMHA

It is not possible to perform stable control if the present value (PV) fluctuates because of fast changes of input signal. Using the Input digital Filter function can stabilize PV to realize more reliable control.

Setting group	Parameter	Set range	Factory default	Unit
Initial Setting	Digital Filter	1 to 1200(0.1 to 120.0)	1(0.1)	Sec



**Ex.**

If the input digital filter is set to 0.4 sec., digital filtering is applied to a sampling value collected over 0.4 sec. (400 ms).



**Note**

- When the input digital filter is used, present value (PV) can vary from the actual input value.
- When the present value is not stable even though setting input digital filter as few second, remove the causes of unstable signal. When input digital filter setting is too high and the present value is stable, it may cause system stability problem due to control with long time.

### 7.1.10 SV high/low-limit value TMH2/4

You can limit the Set value(SV) range within the temperature range of the temperature sensor or analog input type (7.1.1 Input type and range TMH2/4 TMHA) in order to prevent the system from controlling with improper SV.

- Temperature sensor input

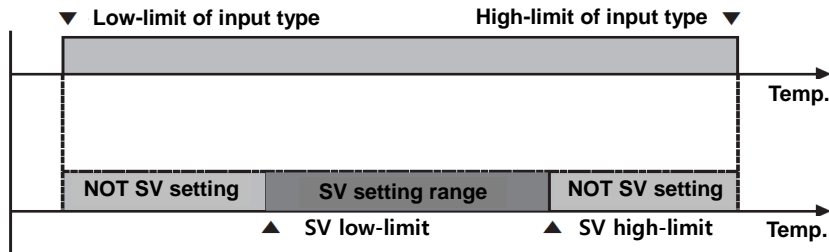

- Analog input

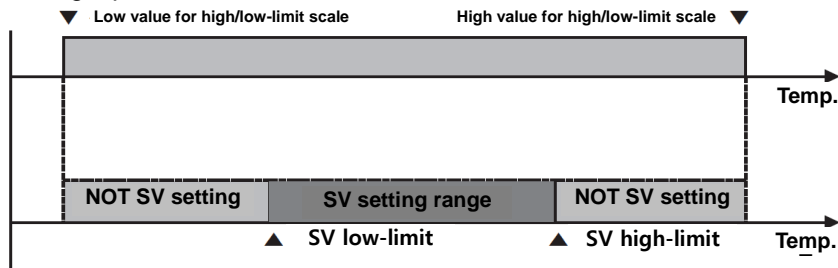

Setting group	Parameter	Set range		Factory default	Unit
Initial Setting Group	SV low limit	Temperature	Input low-limit value to SV high limit – 1-digit	-200	Temperature: °C/°F, Analog: %F.S
		Analog	Low-limit scale value to SV high limit – 1-digit		
	SV high limit	Temperature	SV low-limit – 1-digit to input high-limit value	1350	
		Analog	SV low-limit – 1-digit to high-limit scale value		



**Note**

- It is not available to set over/below value of max./min. value of each input type or high/low-limit value of analog input. The previous set value maintains.
- Set the SV within the SV low-limit value (SV Low Limit) to SV high-limit value (SV High Limit) range.
- It is not available to set as SV low-limit value (SV Low Limit) > SV high-limit value (SV High Limit)
- When changing input type as temperature sensor input, it changes as max./min. value of the changed input type automatically. When it as analog input, it changes as high/low-limit scale value automatically.  
When changing high/low-limit scale value of analog input, the lower value changes as SV low-limit value and the higher value changes as SV high-limit value.

### 7.1.11 Remote SV (RSV) TMH2/4

SV setting is available to set using PV or SV of the other module/channel not the direct setting of the module/channel.

Set the other module's (RSV Master) address, channel, and the target value (PV or SV).

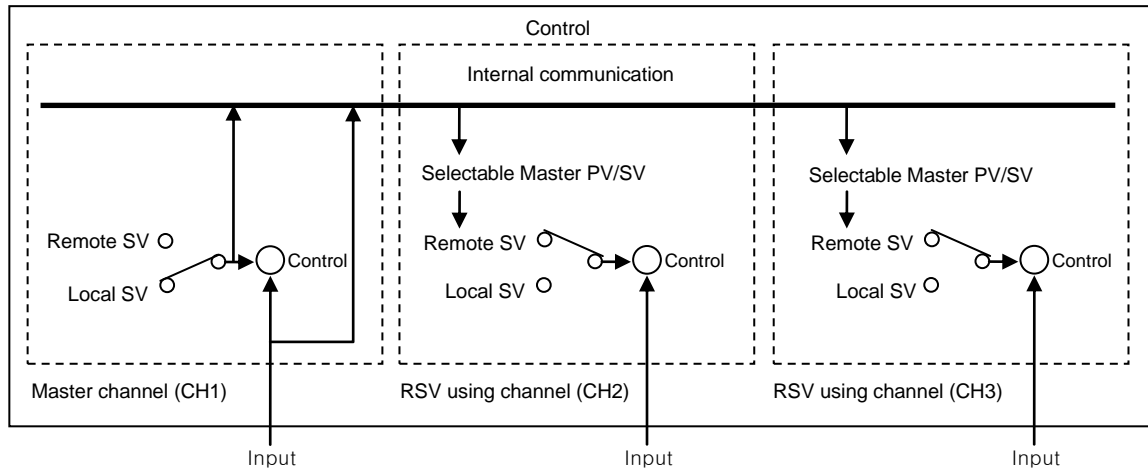

 **Ex.**

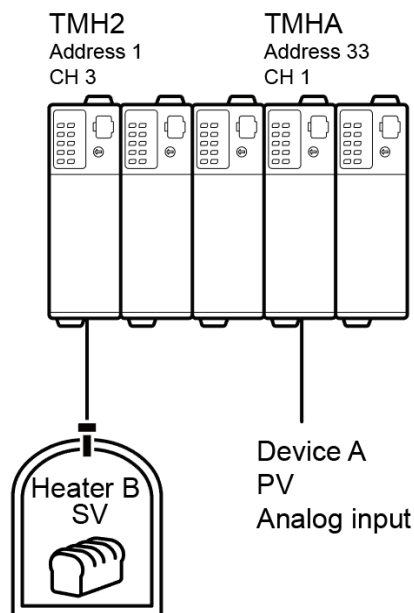

RSV function is available when PV of TMHA (address 33, channel 1) is used for SV of TMH2 (address 1, channel 3).

Set RSV Master setting of TMH2.

RSV Master address: 33, RSV Master channel: 1,  
RSV Master channel target: PV

 **Note**

- When master channel and using channel's input type are temperature → analog or analog → temperature, the value is calculated by each input range of the input type.  
For example, when PV of Master channel is analog input 50.0 and using channel input type is TC K(CA), RSV of using channel is 575 °C as 50% of input range of TC K(CA).
- When using remote SV function and auto-tuning starts, auto-tuning operates by the local SV not remote SV.
- When using remote SV function and remote SV is over SV high/low-limit value range, the SV is limited as SV high/low-limit value.





### 7.1.11.1 RSV Master address

Set the module (RSV Master) address for using SV.

Setting group	Parameter	Set range	Factory default	Unit
Initial Setting	RSV Target Address	0 to 48	0	-

Set the address by communication address switch setting of RSV Master module as below.

Module	SW	7															
		0	1	2	3	4	5	6	7	8	9	A	B	C	D	E	F
TMH4/2	 +0 +16	16	01	02	03	04	05	06	07	08	09	10	11	12	13	14	15
	 +0 +16	32	17	18	19	20	21	22	23	24	25	26	27	28	29	30	31
TMHA		48	33	34	35	36	37	38	39	40	41	42	43	44	45	46	47



#### Note

When RSV Master module address and using address is same, set as '0'. (do not set as the using channel address.)

### 7.1.11.2 RSV Master channel

Set the module (RSV Master) channel for using SV.

Setting group	Parameter	Set range	Factory default	Unit
Initial Setting	RSV Target Ch	0: CH1, 1: CH2 2: CH3, 3: CH4	CH1:0, CH2: 1 CH3: 2, CH4: 3	-

### 7.1.11.3 RSV Master channel target

Set the module (RSV Master) channel target value (PV or SV).

Setting group	Parameter	Set range	Factory default	Unit
Initial Setting	RSV Target	0: OFF, 1: PV, 2: SV	0: OFF	-



#### Note

- Set 0: OFF for not using remote SV(RSV) function.
- When RSV Master address is TMHA(analog input/output module) option module, 2: SV is not available to set.
- When RSV Master address is 0 (RSV Master module address and using channel address are same), and the using channel is same, 1: PV is not available to set.

**7.1.11.4 SV tracking**

When remote SV (RSV) function turns OFF, the remote SV (RSV) is available to set and save as SV. When using this SV tracking function, the previous SV before RSV function is not used. (also saved to multi SV automatically)

If the difference between the previous SV before RSV function and the remote SV (RSV) is large, this function prevents radical change MV by SV changing.

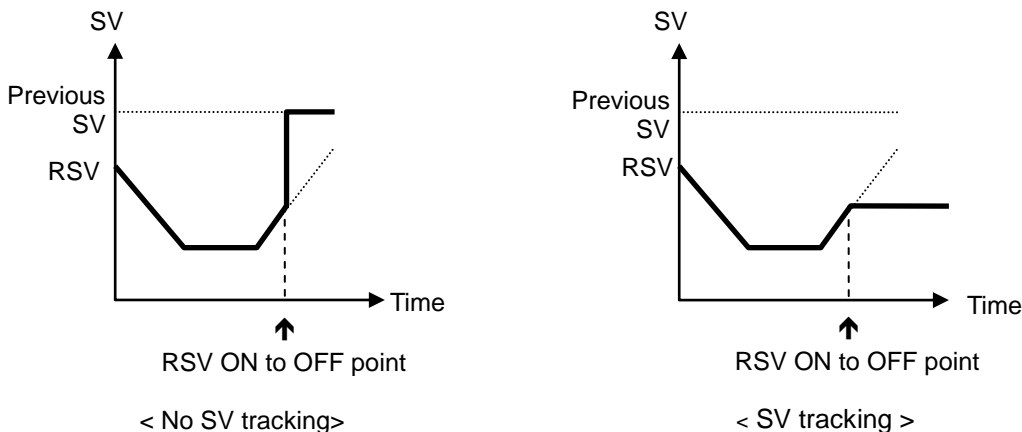

Setting group	Parameter	Set range	Factory default	Unit
Initial Setting	SV Tracking	0: OFF, 1: ON	0: OFF	-

**7.1.11.5 RSV error operation**

When error occurs during RSV function, refer to the below table.

RSV Master channel		Using channel SV display	Using channel output
RSV Master channel target as '1: PV'	HHHH	30000	Standard control: heating control 100%, cooling control 0% Heating&Cooling control: heating 100%, cooling 0%
	LLLL	-30000	Standard control : heating control 0%, cooling control 100% Heating&Cooling control : heating 0%, cooling 100%
	OPEN	31000	Sensor error, MV
Internal communication error	32000		
Channel's communication error	31500		

## 7.2 Control output TMH2/4

### 7.2.1 Control output mode

Control output modes for general temperature control include heating, cooling, and heating & cooling.

Heating control and cooling control are mutually opposing operations with inverse outputs. The PID time constant varies based on the controlled objects during PID control.

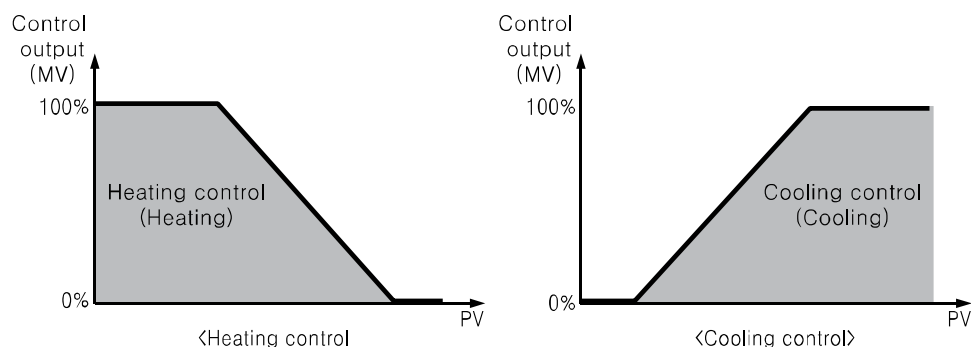

Setting group	Parameter	Set range	Factory default	Unit
Control Operation	Operating Type	0: Heating, 1: Cooling, 2: Heating&Cooling	0: Heating	-



#### Note

When changing control output mode, the reset parameters are as below.

Sensor error, MV	Manual control, initial MV	Control stop, MV
Soft start MV	MV high/low-limit value	Temperature control method
Heating MV	Cooling MV	Dead band/Overlap band

#### (1) Heating control

Heating control mode: the output will be provided in order to supply power to the load (heater) if present value (PV) falls below set value (SV).

#### (2) Cooling control

Cooling control mode: the output will be provided in order to supply power to the load (cooler) if present value (PV) rises above set value (SV).

#### (3) Heating/Cooling control

Heating & Cooling control mode: heating & cooling with a single temperature controller when it is difficult to control subject temperature with only heating or cooling.

Heating & Cooling control mode controls the object using different PID time constants for each heating & Cooling.

It is also possible to set heating & cooling control in both PID control or ON/OFF control mode. Heating/cooling output can be selected among Relay output, SSR drive output and current output depending on model types chosen according to your application environment. (Note that SSR drive output of OUT2 operates standard control.)

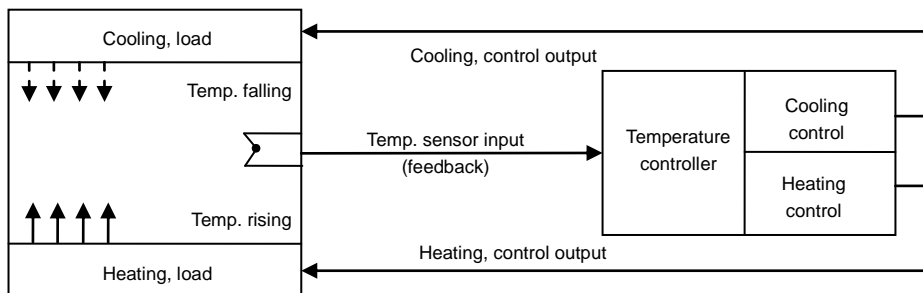

 **Note**

- TMH4/2 Series' operation mode of each channel when setting heating&cooling control output mode

Series	Heating control	Cooling control
TMH2	CH1, CH2	AL1, AL2
TMH4		CH3, CH4

- Heating output is selectable by relay output, current output or SSR drive output, voltage output by model. Cooling output is fixed as relay output.

### 7.2.2 Dead band / Overlap band

In heating & cooling control, it is possible to designate a dead band between heating & cooling control bands based on set value(SV).

- A dead band forms around the SV when positive (+) value is set. No control occurs in the dead band area. Therefore, heating & cooling MVs become 0.0% in the formed dead band.
- An overlap band (simultaneous application of heating & cooling MVs) forms around the SV when negative (-) value is set.

Setting group	Parameter	Set range	Factory default	Unit	
Control Operation	Dead_Overlap band	Temperature H, analog	-999 to 999	0	temperature : °C/°F, analog: %F.S
		Temperature L	-9999 to 9999 (-999.9 to 999.9)		

- Set as 0 when a dead band or an overlap band is not used.
- In case of PID-ON/OFF, ON/OFF-PID temperature control method, ON/OFF control section is not applied dead band and overlap band. Hysteresis and offset value are applied to control.
- In case of temperature input, decimal point of Dead\_Overlap band is depending on input type (H, L) setting.

**(1) Using as dead band**

DB is 10-digit

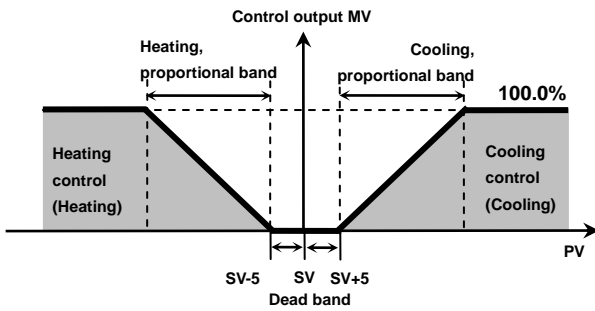

<PID/PID control, heating & cooling control>

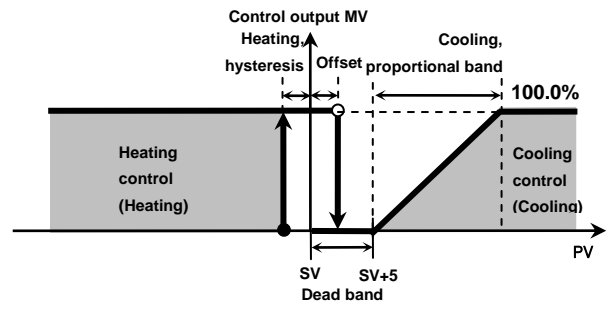

<ONOFF/ PID control, heating & cooling control>

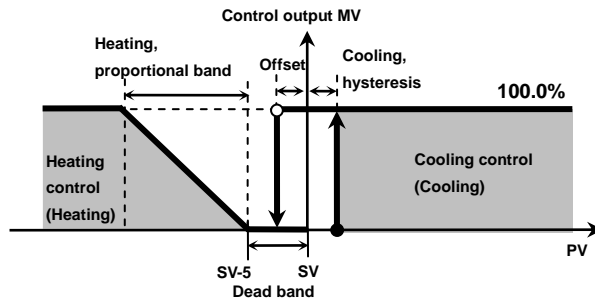

<PID/ONOFF control, heating & cooling control>

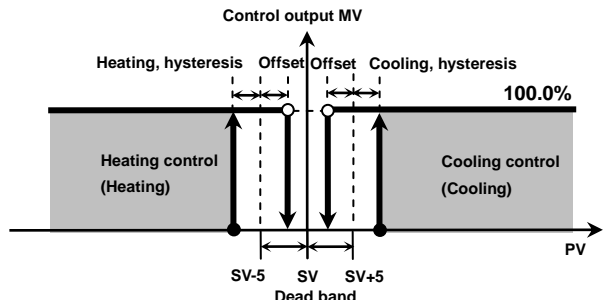

<ONOFF/ONOFF control, heating & cooling control>

In case of analog, % F.S is applied (scale range: 100.0 to 200.0, F.S : 100.0, DB : 10%)

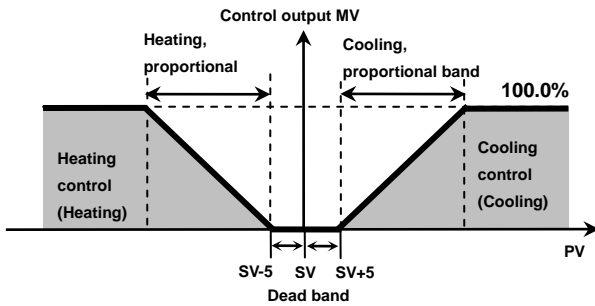

<PID/PID control, heating & cooling control>

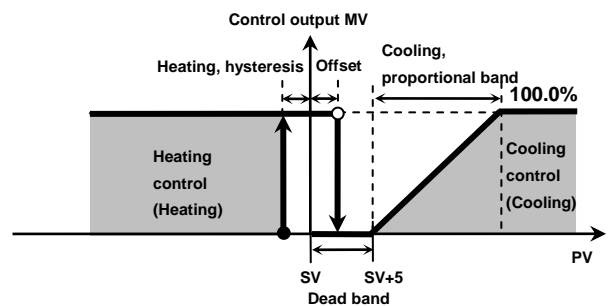

<ONOFF/ PID control, heating & cooling control>

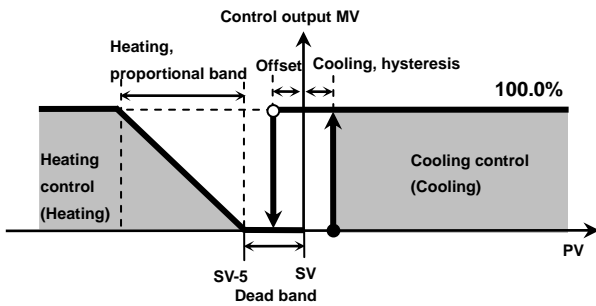

<PID/ONOFF control, heating & cooling control>

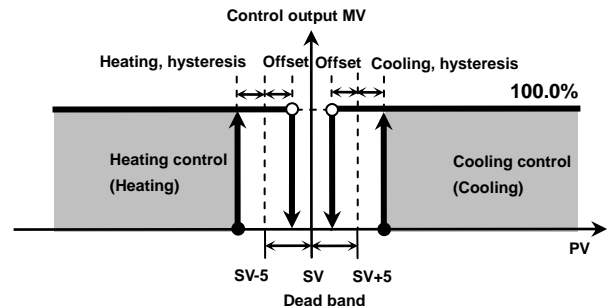

<ONOFF/ONOFF control, heating & cooling control>

**(2) Using as overlap band**

DB is -10 digit

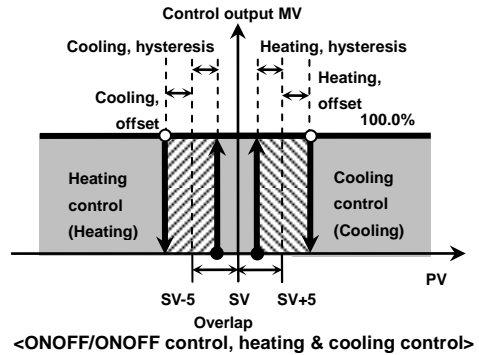
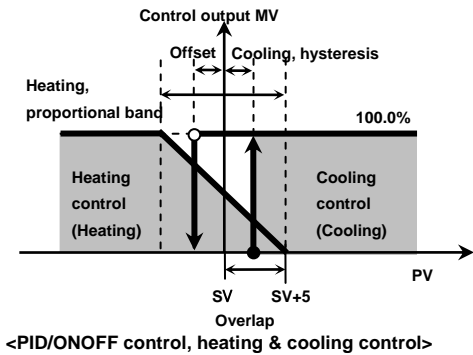
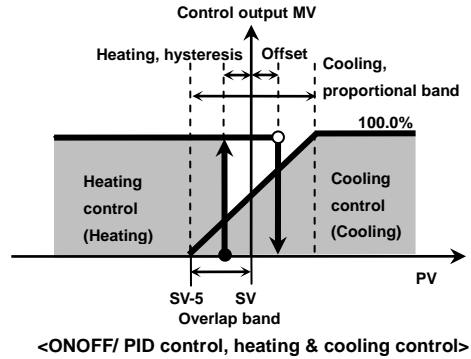
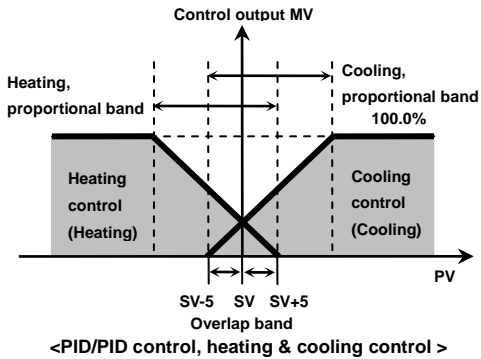

Depending on heating/cooling control, hysteresis, or offset setting, cooling control range may be not included.

In case of analog, % F.S is applied (scale range: 100.0 to 200.0, F.S : 100.0, DB : 10%)

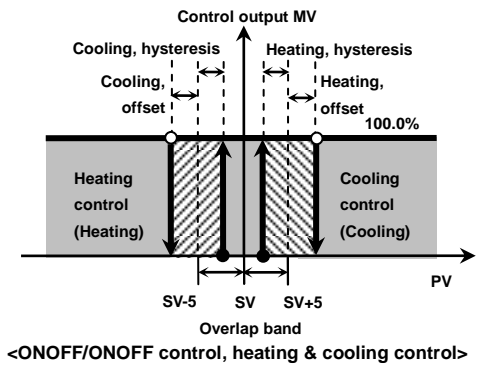
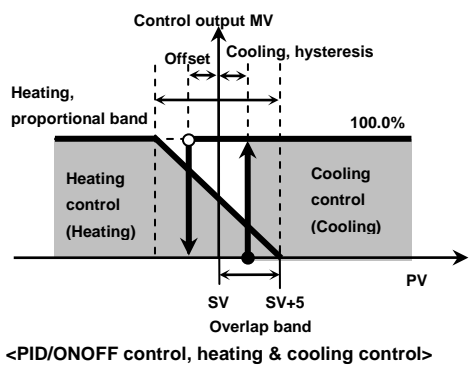
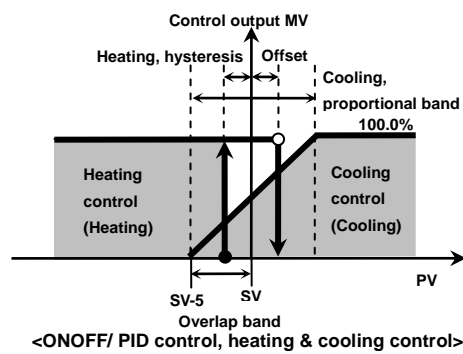
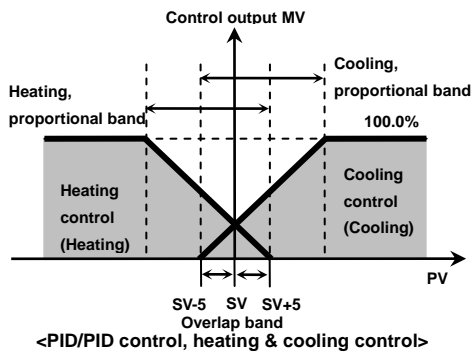

Depending on heating/cooling control, hysteresis, or offset setting, cooling control range may be not included.

**(3) Not using as dead band/overlap band**

DB is 0 digit.

In case of analog, % F.S is applied

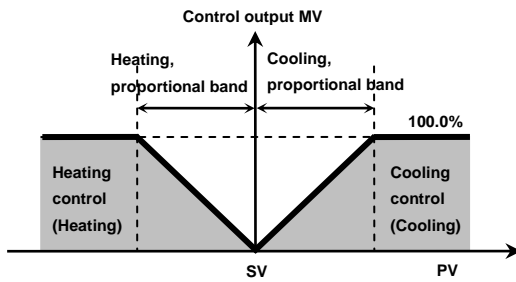

<PID/PID control, heating & cooling control>

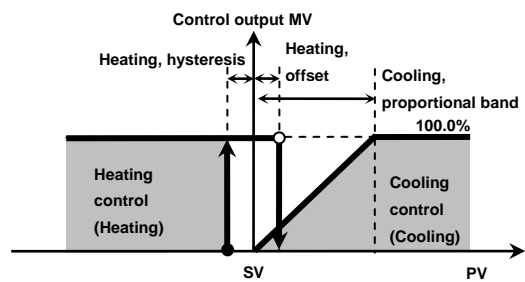

<ONOFF/ PID control, heating & cooling control>

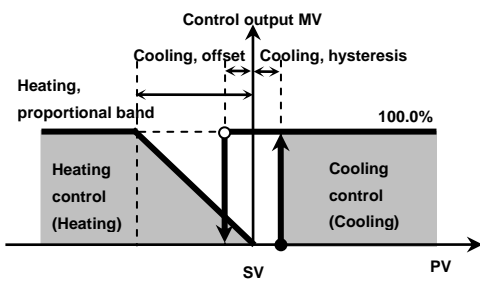

<PID/ONOFF control, heating & cooling control>

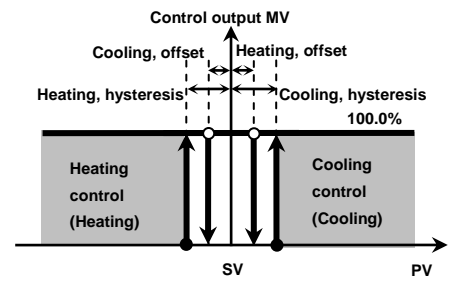

<ONOFF/ONOFF control, heating & cooling control>

### 7.2.3 MV high/low-limit value

MV high/low-limit values for control output can be configured to the actual MV, provided the temperature controller's MV calculation exceeds the limits.

During heating & cooling control, cooling MV carries a "-" prefix. Therefore, the high-limit is expressed as a + value on the heating side and the low-limit as a - value on the cooling side.

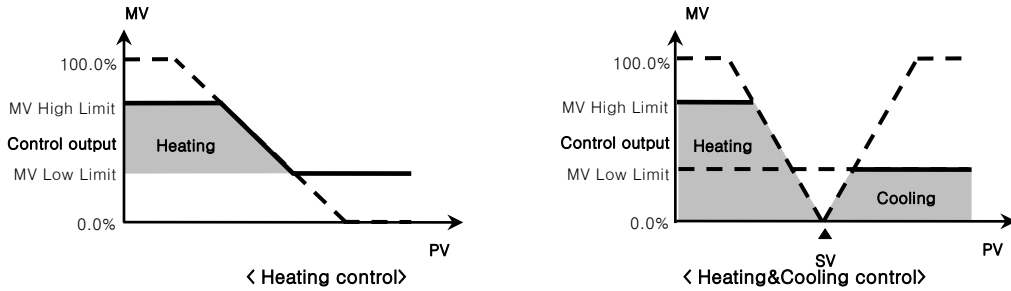

Setting group	Parameter	Set range		Factory default	Unit
Control Operation	MV Low Limit	Heating, Cooling	PID: 0(0.0) to (MV High Limit - 1(0.1))	0(0.0)	%
		Heating&Cooling	PID-PID, ON/OFF-PID: -1000 to 0(-100.0 to 0.0) PID-ON/OFF: -1000/0(-100.0/0.0)	-1000 (-100.0)	
	MV High Limit	Heating, Cooling	PID: (MV Low Limit + 1(0.1)) to 1000(100.0)	1000 (100.0)	
		Heating&Cooling	PID-PID, PID-ON/OFF: 0 to 1000(0.0 to 100.0) ON/OFF-PID: 0/1000(0.0/100.0)	1000 (100.0)	



#### Note

- In case of ON/OFF control of standard control (heating or cooling control), MV high/low-limit value setting is fixed as initial value.
- Same MV limits applied during auto-tuning.
- Manual control, control stop MV, sensor error MV, manual control initial MV are not applied to MV high/low-limit value.



### 7.2.4 MV change rate limit

This function is for limit MV change rate for prevent from control problem (valve control, etc.) or load life cycle problem due to radical change of MV.

MV change rate limit value is set for MV change rate per sec. When MV changing width calculated by control target device is large, the actual output value is increased/decreased gradually by MV change rate limit

It is applied only when the calculated MV change rate per sec is higher than the set MV change rate limit. When it is lower, the calculated MV is output.

Setting group	Parameter	Set range	Factory default	Unit
Control Operation	MV rate limit	0(OFF)/1000(OFF), 1 to 999 (0.1 to 99.9)	0(OFF)	%/SEC



**Note**

- It does not applied during manual control, auto-tuning, ON/OFF control , STOP MV, sensor break MV.
- MV change rate is set by change rate per sec. However, actual MV is applied per sampling cycle (50ms) based on the change rate per sec.



**Ex.**

Example of MV incresement change rate setting

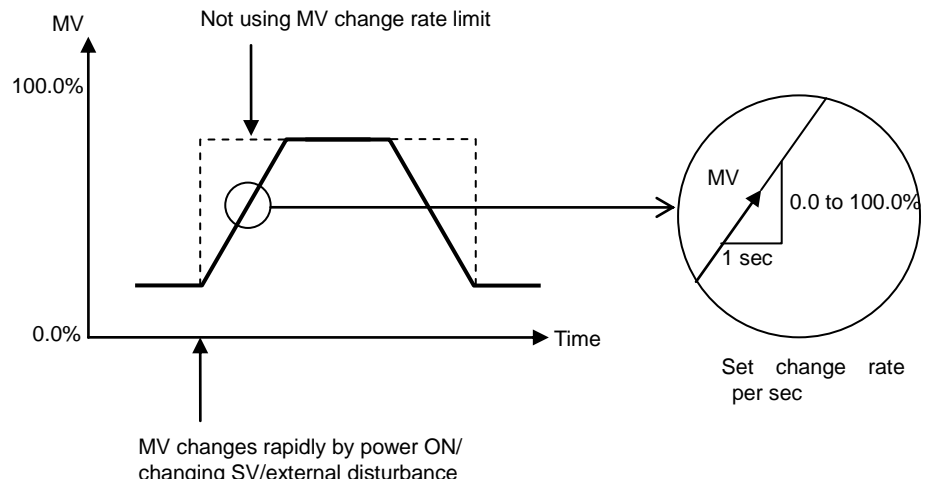

### 7.2.5 Ramp

Ramp is a feature used to configure the changed temperature per unit time toward SV (set value). The feature limits change rate of SV and thereby restricts sudden temperature changes (increase and decrease) in the control subject.

Ramp is commonly used in applications where rapid temperature changes (increase and decrease) could impact negatively on the control subject. For ceramic or pottery furnaces, rapid heating may break the furnace subject. Apply Ramp Up Change Rate to control the temperature.

SV determines the control of the control subject temperature. The SV changes based on the configured changed temperature per unit time (hereinafter referred to as RAMP SV).

Ramp Up change rate and Ramp Down change rate can be set independently.

Setting group	Parameter	Set range	Factory default	Unit
Control Operation	Ramp_Up/Down Rate	0(OFF) to 9999	0	°C/°F/ Digit
	Ramp Time Unit	1: SEC, 2: MIN, 3: HOUR	2: MIN	-



#### Note

- The temperature control for target operates based on the changed SV (RAMP SV) according to the set change rate (gradient).
- Activating the ramp feature when the ramp is not in operation limits the rate of SV (set value) change based on PV (present value). Changing SV or ramp parameters when the ramp is in operation limits the rate of SV change based on SV at the point of the change.
- Alarm activation with the ramp in operation depends on the final SV.
- Ramp up/down change rate is set changing rate by ramp time unit (Sec/Min/Hour). However, actual Ramp function is applied per sampling cycle (50ms) based on the ramp time unit change rate.

#### (1) Ramp depending on operation status

Operation status	RAMP Up/Down	RAMP function
All operations	When it is 0,	Inactive
OPEN, HHHH, LLLL, Auto-Tuning, Auto→Manual, RUN→STOP, After auto-tuning completed, PV = SV	Irrespective of conditions.	Inactive
Power ON, SV changing, STOP→RUN, Manual→Auto, Changing ramp rate or ramp time unit	When it is not 0,	Active



Ex.

Graph example of ramp function

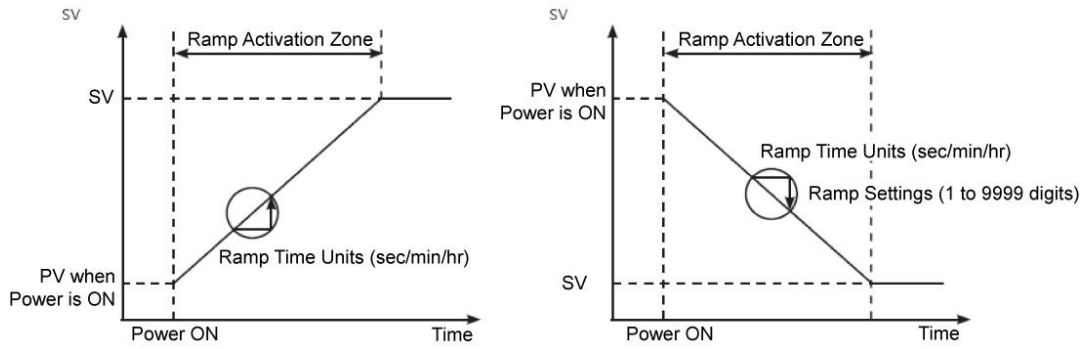

<Initial power on, Ramp value change>

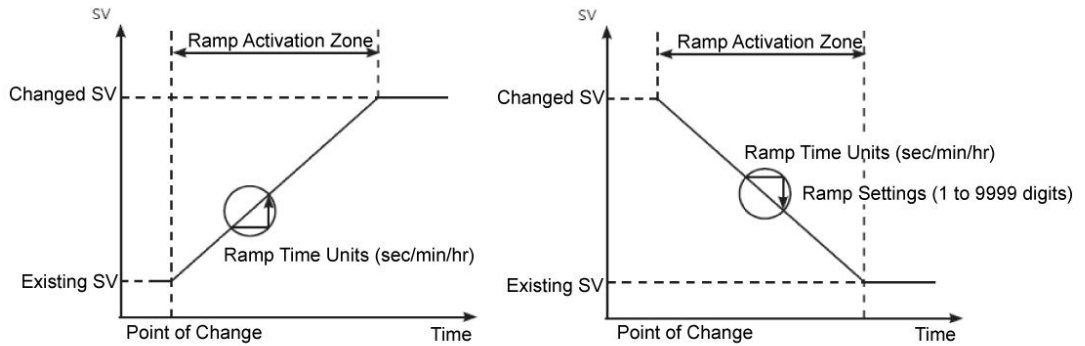

<SV setting change, Change SV setting with multi SV feature>

### 7.2.6 Soft start

Soft start operates once only when power ON by setting the desired time/unit and MV.

This function does not operate during manual control, stop running, input error OPEN/HHHH/LLLL. When the related parameter during soft start operation, the changed parameter is applied including the progressed time.

Setting group	Parameter	Set range			Factory default	Unit
Control Operation	Soft start time	0(OFF), 1 to 9999			0(OFF)	-
	Soft start time unit	0: SEC, 1: MIN, 2: HOUR			0: SEC	-
	Soft start MV	Heating, Cooling	PID	0 to 1000(0.0 to 100.0)	1000(100.0)	-
			ON/OFF	0/1000(0.0/100.0)		
		Heating& Cooling	PID-PID	-1000 to 1000 (-100.0 to 100.0)		
			PID-ON/OFF	-1000(-100.0), 0 to 1000(0.0 to 100.0)		
ON/OFF-PID	-1000 to 0(-100.0 to 0.0), 1000(100.0)					
ON/OFF-ON/OFF	-1000/0/1000 (-100.0/0.0/100.0)					

### 7.2.7 Auto/Manual control

- Auto control mode is make temperature reach SV with MV calculated by PID control.
- Manual control mode is to make temperature reach SV with user's defined MV.

Setting group	Parameter	Set range	Factory default	Unit
Monitoring	Auto-Manual Control	0: AUTO, 1: MANUAL	0: AUTO	-



#### Note

- Digital input terminal is set as manual control and external digital input terminal used for auto/manual control. The parameter setting of Auto/Manual control is not available.
- For ON/OFF control, auto/manual control switching is available.
- When power turns OFF and ON during auto/manual control, it maintains auto/manual control.
- During auto-tuning and switching to manual control, auto-tuning stops.
- During control stop, input break, manual control switching is available.  
priority: manual control > STOP > OPEN (input break)
- During control operation, auto/manual control switching is available.
- During manual control, the other parameter is not to set except H-MV, C-MV, auto/manual control.

#### 7.2.7.1 Baseline MV for manual control

When switching from auto control to manual control you can set the initial MV.

- AUTO-MV: Controlling with auto control MV as an initial MV for manual control.
- PRESET-MV: Controlling with preset manual MV as initial MV.

Setting group	Parameter	Set range	Factory default	Unit
Control Setting	Initial Manual MV	0: AUTO-MV, 1: PRESET-MV	0: AUTO-MV	-

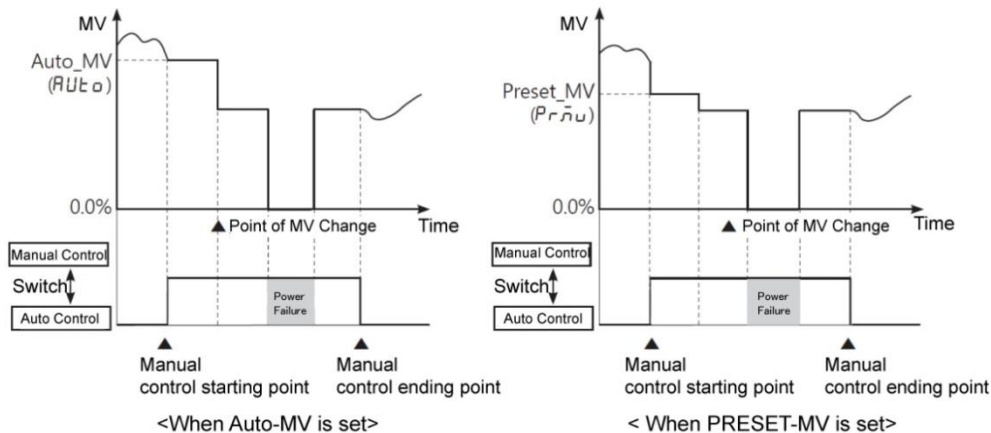

**Note**

When re-supplying the power, it controls with the MV which is at the power OFF.

**7.2.7.2 Initial MV for manual control**

If the baseline MV for manual control is configured to PRESET-M, you can set the initial MV for manual control.

Setting group	Parameter	Set range			Factory default	Unit
Control Setting	Preset Manual	Heating, Cooling	PID	0 to 1000 (0.0 to 100.0)	0(0.0)	%
			ON/OFF	0/1000 (0.0/100.0)		
		Heating& Cooling	PID-PID	-1000 to 1000 (-100.0 to 100.0)		
			PID-ON/OFF	-1000(-100.0), 0 to 1000(0.0 to 100.0)		
			ON/OFF -PID	-1000 to 0(-100.0 to 0.0), 1000(100.0)		
			ON/OFF - ON/OFF	-1000/0/1000 (-100.0/0.0/100.0)		

**Note**

When in heating & cooling control mode, a setting between 0.1 to 100.0 will be applied as heating MV and a setting between -0.1 to -100.0 will be applied as cooling MV.

**7.2.7.3 Select SV when auto control switching**

When changing manual control to auto control, set SV as the PV.

In case of input error, OPEN, HHHH, LLLL, it maintains the previous SV.

Setting group	Parameter	Set range	Factory default	Unit
Control Operation	PV transfer	0: OFF, 1: ON	0: OFF	-

### 7.2.8 **Control output**

In case of selecting the Models with current control output, both current and SSR drive outputs are available. You can therefore choose the right output type depending on application environments.

Setting group	Parameter	Set range	Factory default	Unit
Initial Setting	Heating/Cooling_Output Type	0: SSR, 1: Current	1: Current	-

### 7.2.9 **Current output range**

When control output is current output, high/low-limit range of current output is selectable one; 4-20mA or 0-20mA.

Setting group	Parameter	Set range	Factory default	Unit
Initial Setting	Heating/Cooling_Current Output Range	0: 4-20, 1: 0-20,	0: 4-20	mA



#### **Note**

This parameter is available only when control output setting is 1: Current.

## 7.3 Analog transmission output TMHA

Transmission output is for sub output not for control output. It is available to transmit PV, SV, heating MV(H-MV), or cooling MV(C-MV) to external device. Only analog value of TMH2/4/A is available to transmission.

### 7.3.1 Analog transmission output

The PV, SV, heating MV(H-MV), or cooling MV(C-MV) of TMH2/4/A is transmitted as the converted DC4-20mA analog current to external device.

Setting group	Parameter	Set range	Factory default	Unit
Analog Output Setting	Analog Output	0: PV, 1: SV, 2: H-MV, 3: C-MV	0: PV	-



#### Note

- Transmission output is constant current output. The resistance value of load (over 500Ω) is too large, output value may be changed.
- When transmission output target module is TMHA, only '0: PV' is selectable.
- When transmitting SV and during RAMP operation, RAMP SV is transmitted by level.

### 7.3.2 Transmission output target address

Set target address for transmission output.

Setting group	Parameter	Set range	Factory default	Unit
Analog Output Setting	Analog Output Target	0 to 48	0	-

Set the address by communication address switch setting of each module as below.

Module \ SW																	
		0	1	2	3	4	5	6	7	8	9	A	B	C	D	E	F
TMH4/2		16	01	02	03	04	05	06	07	08	09	10	11	12	13	14	15
		32	17	18	19	20	21	22	23	24	25	26	27	28	29	30	31
TMHA		48	33	34	35	36	37	38	39	40	41	42	43	44	45	46	47



#### Note

When transmission output target address and using channel address is same, set as '0'. (do not set as the using channel address.)

### 7.3.3 Transmission output target channel

Set the target channel to transmission output.

Setting group	Parameter	Set range	Factory default	Unit
Analog Output Setting	Analog Output Target Ch	0: CH1, 1: CH2 2: CH3, 3: CH4	CH1:0, CH2: 1 CH3: 2, CH4: 3	-

### 7.3.4 Current output range

Select high/low-limit range of 4-20mA or 0-20mA for current transmission output.

Setting group	Parameter	Set range	Factory default	Unit
Analog Output Setting	Analog Output Range	0: 4-20, 1: 0-20	0: 4-20	mA

### 7.3.5 Transmission output high/low-limit value

Within the set current output high/low-limit range (4-20mA or 0-20mA), it limits transmission output range.

Setting group	Parameter	Set range		Factory default	Unit	
Analog Output Setting	Full Scale Low	PV	Temperature	Refer to 7.1.1 Input type and range <b>TMH2/4</b> <b>TMHA</b>	-200	-
			Analog	Analog scale low-limit value(Low-limit Scale Value) to Analog scale high-limit value(High-limit Scale Value)		
		SV		SV low-limit value(SV Low Limit) to SV high-limit value(SV High Limit)		
		H-MV/C-MV		0 to 1000(0.0 to 100.0)		
	Full Scale High	PV	Temperature	Refer to 7.1.1 Input type and range <b>TMH2/4</b> <b>TMHA</b>	1350	-
			Analog	Analog scale low-limit value(Low-limit Scale Value) to Analog scale high-limit value(High-limit Scale Value)		
		SV		SV low-limit value(SV Low Limit) to SV high-limit value(SV High Limit)		
		H-MV/ C-MV		0 to 1000(0.0 to 100.0)		



#### Note

When high-limit value and output low-limit value for transmission output are same, it outputs 4mA.



## 7.4 Temperature control TMH2/4

### 7.4.1 Temperature control method

You can choose the type of temperature control method.

Setting group	Parameter	Set range		Factory default	Unit
Initial Setting	Control Method	Heating, Cooling	0: PID, 1: ONOFF	0: PID	-
		Heating& Cooling	0: PID-PID 1: PID-ONOFF 2: ONOFF-PID 3: ONOFF-ONOFF	0: PID-PID	-

### 7.4.2 ON/OFF control

Controls the temperature by comparing present value (PV) with set value(SV) and turning power to the load on or off.

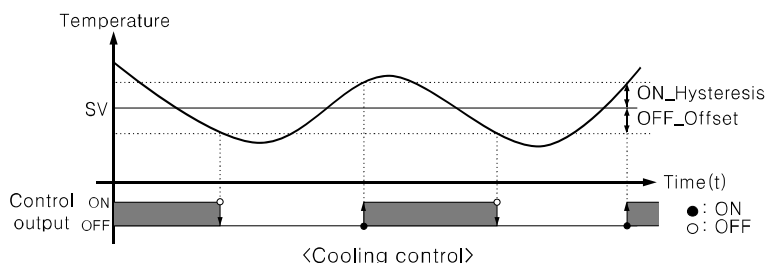
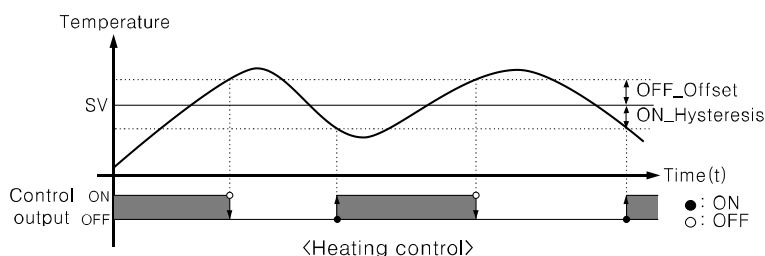

#### 7.4.2.1 Hysteresis/Offset

Hysteresis is to adjust control output ON/OFF point in ON/OFF control mode. ON\_Hysteresis sets the output on point and OFF\_Offset sets the off point.

Setting hysteresis too low can result in hunting induced by disturbance (noise, chattering, etc.). To minimize hunting, set ON\_Hysteresis and OFF\_Offset values with consideration to the heater or cooler's capacity and thermal characteristics, the control subject's response characteristics, the sensor's response characteristics and installation conditions, and other defining factors.

Setting group	Parameter	Set range		Factory default	range
Control Operation	Heating/Cooling_ON Hysteresis	Temperature H, analog	1 to 100	2	Temperature: °C/°F, Analog: %F.S
		Temperature L	1 to 1000(0.1 to 100.0)	20(2.0)	
	Heating/Cooling_OFF Offset	Temperature H, analog	0 to 100,	0	
		Temperature L	0 to 1000(0.0 to 100.0)		

### 7.4.3 PID control

PID control is a combination of proportional (P), integral (I), and derivative (D) controls and offers superb control over the control subjects, even with a delay time.

Proportional control (P) implements smooth, hunting-free control; integral control (I) automatically corrects offsets; and derivative control (D) speeds up the response to disturbance. Through these actions, PID control realizes ideal temperature control.

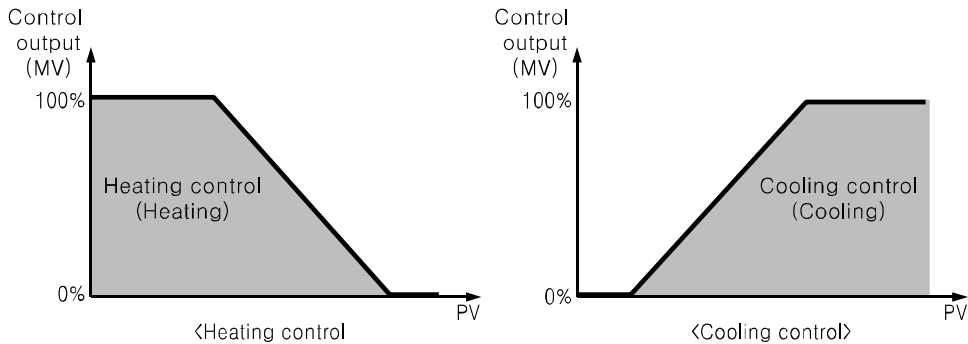

#### Note

Applied method for PID control

- Proportional (P) control : Select PID control and set the integral and derivative time as 0.
- Proportional integral(PI) control : Select PID control and set the derivative time as 0.
- Proportional derivative(PD) control : Select PID control and set the integral time as 0.
- Multi SV: Use the same PID time constant for the values of SV 0 to SV 3.

#### 7.4.3.1 Proportional band

When present value (PV) is within the Proportional Band (P), the ON/OFF ratio needs to be adjusted during the proportional period (T). The defined proportional control (time proportional control) section is called as the proportional band.

Setting group	Parameter	Set range		Factory default	Unit
Control Operation	Heating/ Cooling _Proportional Band	Temperature H, analog	1 to 999	10	temperature: °C/ °F,
		Temperature L	1 to 9999(0.1 to 999.9)	100(10.0)	analog: %F.S

### 7.4.3.2 Integral time

MVs from integral and proportional operation become the same when deviation is consistent. The time taken for the two MVs to match is called the integral time.

Setting group	Parameter	Set range	Factory default	Unit
Control Operation	Heating/ Cooling _Integral Time	0 to 9999	0	Sec



#### Note

- Integral control is not conducted if the integral time is set to 0.
- Setting the integral time too short can intensify correction movements and cause hunting.

### 7.4.3.3 Derivative time

In accordance with the deviation of the ramp, the time taken for the MV gained from derivative operation to reach the MV gained from proportional control is called the derivative time.

Setting group	Parameter	Set range	Factory default	Unit
Control Operation	Heating/ Cooling _ Derivation Time	0 to 9999	0	Sec



#### Note

Derivative control is not conducted if the derivative time is set to 0.

### 7.4.3.4 Control period

If relay or SSR is used to output MV under proportional control, the output is on for a fixed amount of time (within the control period, as a percentage of the MV) and then remains off for the rest of the time. The preset period when output ON/OFF takes place is called the proportional control period.

Control with SSR drive output has a faster response than that of relay output. Therefore, by configuring a shorter control period, more responsive temperature control is achieved.

Setting group	Parameter	Set range	Factory default	Unit
Initial Setting	Heating/ Cooling _ Control Time	Relay output: 0.1 to 120.0 sec, SSR output: 1.0 to 120.0 sec	Relay: 200(20.0) SSR: 20(2.0)	Sec



#### Note

- If using heating & cooling control, configure each control period separately for heating & cooling.
- When control output setting is 1: Current, control period parameter is not activated.

### 7.4.3.5 Offset correction/Manual reset

When selecting P / PD control mode, there are certain temperature differences even after PV reaches stable status since heater's rising and falling time is inconsistent due to thermal characteristics of control objects, such as heat capacity and the heater capacity. This temperature difference is called OFFSET. Offset can be corrected using manual reset.

Setting group	Parameter	Set range	Factory default	Unit
Control Operation	Manual Reset	0 to 1000(0.0 to 100.0)	500(50.0)	%



#### Note

- Manual reset adjustments based on control results

Under stable control conditions, set the offset to 50% if PV and SV are identical, to over 50.0% if PV is lower than SV, and to below 50.0% if PV is higher than SV.

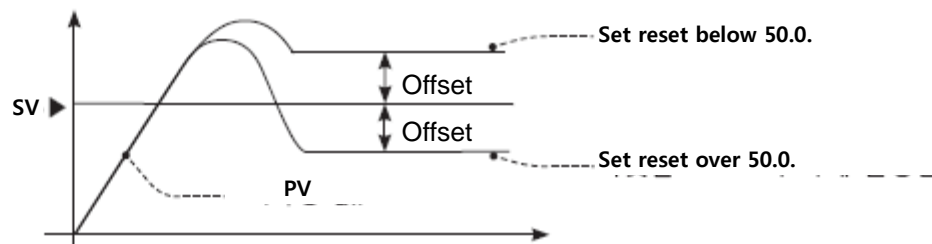

- Normal deviation correction function is available only when proportional control (P, PD control). When integral time is set as 0 sec, manual reset parameter is activated.
- During heating&cooling control, manual reset is not available to set manual.
- During heating&cooling control to standard control, when proportional control (P, PD control) operates, normal deviation correction function executes with the previous set manual reset value.

## 7.4.4 Auto-tuning

Auto tuning measures the control subject's thermal characteristics and thermal response rate, and then determines the necessary PID time constant.

### 7.4.4.1 Auto-tuning start/stop

- Auto-tuning automatically stores PID time constants upon termination. These PID time constants can then be modified by the user to suit their usage environment.
- When auto-tuning is in progress, the channel output LED flashes in 1 sec. intervals. When auto-tuning finishes, the output LED turns OFF and the parameter set value is also returned to OFF automatically.

Setting group	Parameter	Set range	Factory default	Unit
Control Operation	Auto-Tuning Execute	0: OFF, 1: ON	0: OFF	-



### Note

- When selecting manual control during auto-tuning, auto-tuning stops.
- When sensor break error occurs during auto-tuning, auto-tuning stops automatically and the previous PID value maintains.
- Auto-tuning continues to run even if the temperature reading exceeds or falls below the input range.
- When auto-tuning is in progress, parameters can only be referenced and not altered.
- During auto-tuning when external digital input function is RUN/STOP or AUTO/MANUAL and the digital signal inputs or sensor break alarm occurs, auto-tuning stops. (the previous PID value maintains)
- Auto-tuning is not available in manual control.

**7.4.4.2 Auto-tuning(AT) mode**

There are auto-tuning(AT) modes according to base line; TUNE 1 mode (based on SV), TUNE 2 mode(based on SV+TUNE 2 mode deviation value).

- TUNE 1 mode: Auto-tuning operates based on SV and PID value is calculated.
- TUNE 2 mode: Auto-tuning operates based on SV+TUNE 2 mode deviation and PID value is calculated.

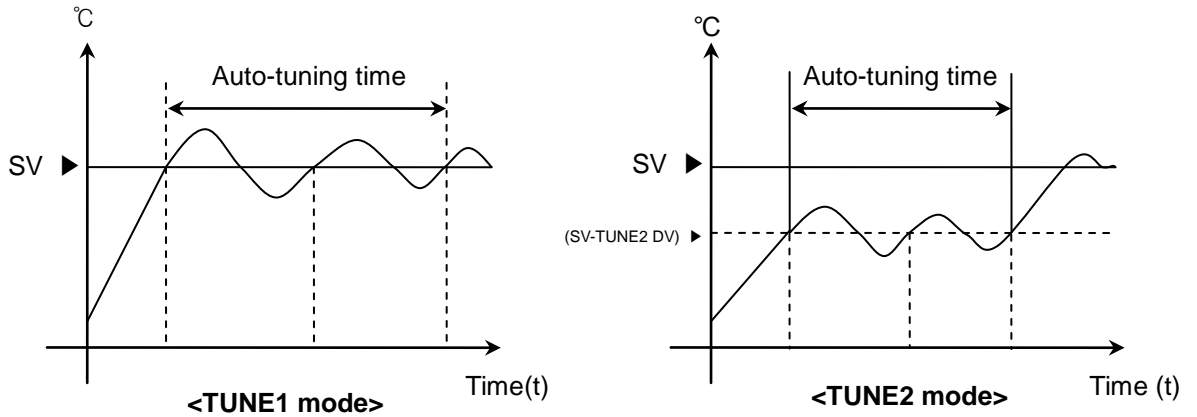

Setting group	Parameter	Set range	Factory default	Unit
Initial Setting	Auto-Tuning Mode	0: TUNE 1 , 1: TUNE 2	0: TUNE 1	-

**7.4.4.3 TUNE 2 mode deviation value**

Set deviation value for TUNE 2 mode of auto-tuning(AT) mode.

Setting group	Parameter	Set range	Factory default	Unit	
Initial Setting	TUNE 2 DV	Temperature H, analog	-9999 to 9999	0	Digit
		Temperature L	-9999 to 9999 (-999.9 to 999.9)		



When SV is set as 100, and TUNE2 deviation value is set as -10, auto-tuning with TUNE2 operates based on  $100+(-10)=90$ .

## 7.5 Alarm output

Alarm output is a relay output that activates irrespective of control output. Alarm output works when the temperature of the controlled subject exceeds or falls below the preset temperature range.

Alarm temperature set values consist of absolute temperatures or deviation temperatures, depending on the alarm output mode.

Alarm output is only for TMH2 or TMHE option module.

### 7.5.1 Alarm configurations

Alarm output (Alarm) is output terminal and alarm (Event) is for alarm setting by each channel.

One channel is available to set total 4 alarms (Event 1 to 4).

One alarm consists of alarm mode, option, set value, hysteresis, delay time, output address, and channel settings, etc.

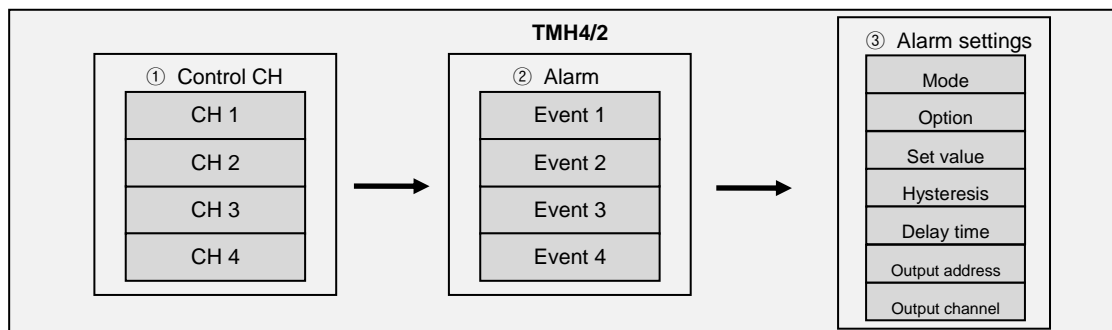

**(2) Using TMH2 built-in alarm output**

TMH2 outputs built-in alarm when alarm condition occurs. (address: 00, TMH2 alarm output of the other address is not available.)

Several alarm (Event 1 to 4) is selectable as one alarm output and AND/OR operation is selectable at TMH2.

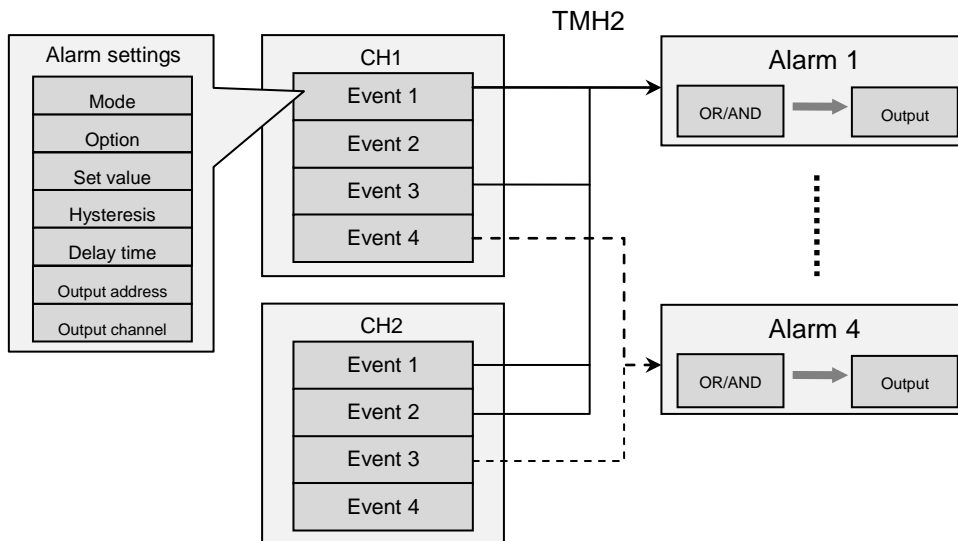

**(3) Using TMHE option module alarm output**

TMH2/4 is connectable to TMHE option module. (according to address setting)

TMH4 does not have built-in alarm and TMHE option module outputs alarm when alarm condition occurs by internal communication.

Several alarm (Event 1 to 4) is selectable as one alarm output and AND/OR operation is selectable at TMHE.

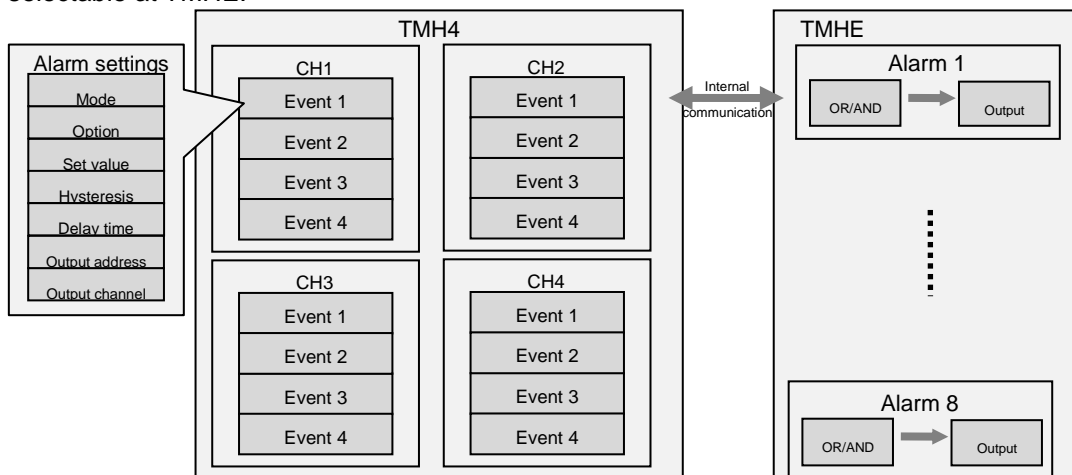

 **Note**

Several alarm (Event 1 to 4) of TMH2 is selectable as one alarm output of TMHE and AND/OR operation is selectable at TMHE.



### 7.5.2 Alarm output mode TMH2/4

Select the desired alarm operation.

Setting group	Parameter	Set range	Factory default	Unit
Event Setting	Event Mode	Refer to the below table.	1: AL-1	-

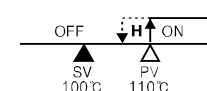
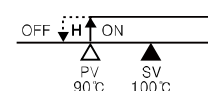
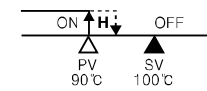
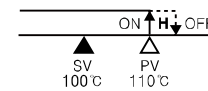
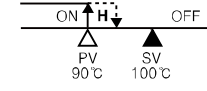
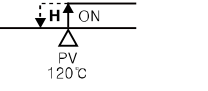
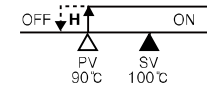
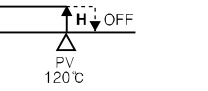
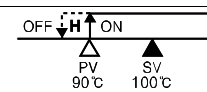
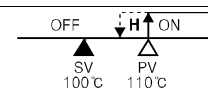
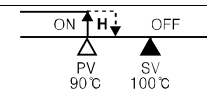
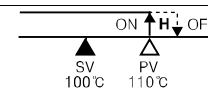
Mode	Name	Alarm operation	Description
0: OFF	-	—	No alarm output
1: AL-1	Deviation high-limit alarm	 <p>High deviation: Set as 10°C</p>  <p>High deviation: Set as -10°C</p>	If deviation between PV and SV as high limit is higher than set value of deviation temperature, the alarm output will be ON.
2: AL-2	Deviation low-limit alarm	 <p>Lower deviation: Set as 10°C</p>  <p>Lower deviation: Set as -10°C</p>	If deviation between PV and SV as low limit is higher than set value of deviation temperature, the alarm output will be ON.
3: AL-3	Deviation high/low-limit alarm	 <p>Lower deviation: Set as 10°C, High deviation: Set as 20°C</p> 	If deviation between PV and SV as high/low limit is higher than set value of deviation temperature, the alarm output will be ON.
4: AL-4	Deviation high/low-limit reverse alarm	 <p>Lower deviation: Set as 10°C, High deviation: Set as 20°C</p> 	If deviation between PV and SV as high/low-limit is higher than set value of deviation temperature, the alarm output will be OFF.
5: AL-5	Absolute value high-limit alarm	 <p>Alarm absolute value: Set as 90°C</p>  <p>Alarm absolute value: Set as 110°C</p>	If PV is higher than the absolute value, the output will be ON.
6: AL-6	Absolute value low-limit alarm	 <p>Alarm absolute value: Set as 90°C</p>  <p>Alarm absolute value: Set as 110°C</p>	If PV is lower than the absolute value, the output will be ON.
7: LBA	Loop break alarm	—	It will be ON when it detects loop break.
8: SBA	Sensor break alarm	—	It will be ON when it detects sensor disconnection.
9: HBA	Heater break alarm	—	It will be ON when CT detects heater break.

### 7.5.3 Alarm output option TMH2/4

Users can select the desired alarm output options.

Each alarm (Event 1 to Event 4) is settable individually.

Setting group	Parameter	Set range	Factory default	Unit
Event Setting	Event Type	Refer to the below table.	0: AL-A	-

Setting	Mode	Description
0: AL-A	Standard alarm	If it is an alarm condition, alarm output is ON. If it is a clear alarm condition, alarm output is OFF.
1: AL-B	Alarm latch ※ <sup>1</sup>	If it is an alarm condition, alarm output is ON and maintains ON status.
2: AL-C	Standby sequence 1※ <sup>2</sup>	First alarm condition is ignored and from second alarm condition, standard alarm operates. When power is supplied and it is an alarm condition, this first alarm condition is ignored and from the second alarm condition, standard alarm operates.
3: AL-D	Alarm latch and standby sequence 1	If it is an alarm condition, it operates both alarm latch and standby sequence. When power is supplied and it is an alarm condition, this first alarm condition is ignored and from the second alarm condition, alarm latch operates.
4: AL-E	Standby sequence 2	First alarm condition is ignored and from second alarm condition, standard alarm operates. When re-applied standby sequence and if it is alarm condition, alarm output does not turn ON. After clearing alarm condition, standard alarm operates.
5: AL-F	Alarm latch and standby sequence 2	Basic operation is same as alarm latch and standby sequence <sup>1</sup> . It operates not only by power ON/OFF, but also alarm set value, or alarm option changing. When re-applied standby sequence and if it is alarm condition, alarm output does not turn ON. After clearing alarm condition, alarm latch operates.

※ 1. Condition of re-applied alarm latch, alarm latch and standby sequence 1, alarm latch and standby sequence 2, standby sequence alarm: Power OFF, digital input is supplied as event reset function.

※ 2. Condition of re-applied standby sequence alarm: Power ON, changing SV, changing parameters for alarm (output mode, option, set value), switching STOP mode to RUN mode.



#### Note

- If alarm operation is set as LBA, SBA, HBA, AL-C, AL-D, AL-E, AL-F modes are not displayed.



Ex.

In case of SV: 100°C, alarm output operation mode: AL-3(deviation high/low-limit alarm), alarm option: AL-E(standby sequence 2),

(high/low-limit deviation temperature: 10°C, alarm output hysteresis: 5°C)

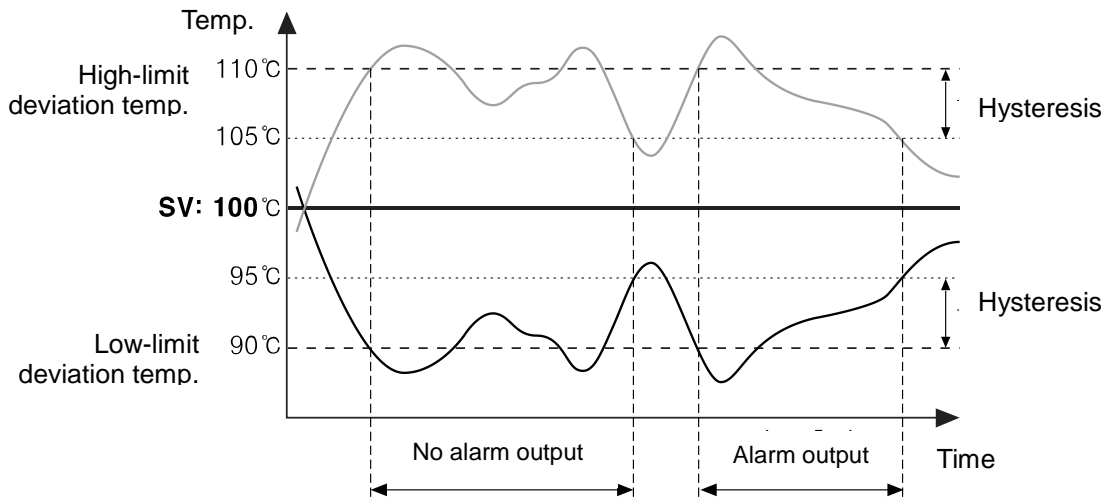

Alarm output operates from the second alarm condition not the first alarm condition.

### 7.5.4 Alarm SV TMH2/4

You can set alarm output activation values. According to the selected alarm operation, configuration parameters (AL□.H/AL□.L) will be activated for each setting.

Setting group	Parameter	Set range	Factory default	Unit
Event Setting	Event High Event Low	Deviation alarm: -F.S. to F.S of the input type Absolute value alarm: Display range of the input type	1550	-



Note

Changing the alarm operation or options resets the settings to the highest or lowest values that will not trigger output in the new mode.

**7.5.5 Alarm output hysteresis** TMH2/4

At "7.5.2 Alarm output mode", "H" from alarm operation represents the alarm output hysteresis. It is used to set an interval between alarm outputs ON/OFF period. When PV is over or below the alarm output set value, alarm output turns ON and OFF according to the set hysteresis. When input value varies around the set value, alarm output turns ON frequently. To set hysteresis prevents frequent alarm outputs.

Setting group	Parameter	Set range	Factory default	Unit
Alarm Setting	Alarm Hysteresis	Temperature H, analog	1 to 100	1
		Temperature L	0.1 to 100.0	1(0.1)
				temperature: °C/°F, analog: Digit



**Note**

- Alarm output hysteresis applies to heater break alarm (HBA) in the same manner.
- This parameter does not appear when loop break alarm (LBA), or sensor break alarm (SBA) is selected.

**7.5.6 Alarm output delay time** TMH2/4

Alarm output delay can be set to prevent false alarms caused by erroneous input signals resulting from disturbances or noise.

With a preset delay time, alarm output does not turn on for the preset duration. Instead, the concerned alarm indicator on the front will flash in 0.5 sec. intervals.

- Alarm output ON delay time (Alarm ON Delay Time): Based on the occurring point of alarm output, it waits for the set delay time and checks alarm output condition. When the condition is meet the alarm output, the output turns ON.
- Alarm output OFF delay time (Alarm OFF Delay Time): Based on the releasing point of alarm output, it waits for the set delay time and checks alarm output condition. When the condition is meet the alarm output, the output turns OFF.

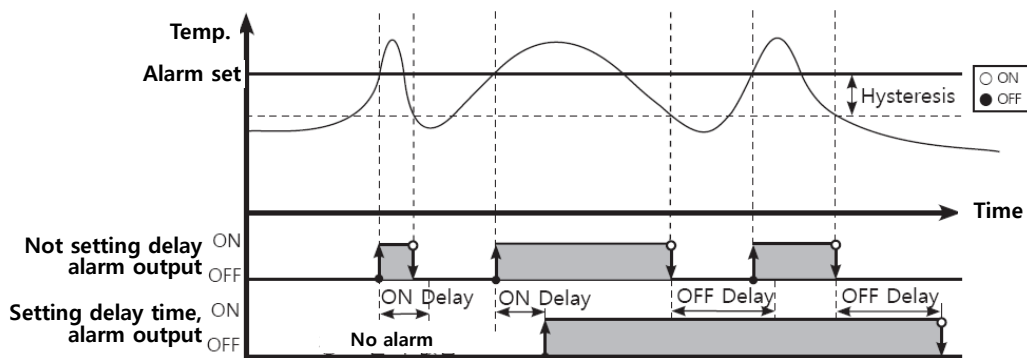

Setting group	Parameter	Set range	Factory default	Unit
Event Setting	Event ON Delay Time	0 to 3600	0	Sec
	Event OFF Delay Time	0 to 3600	0	Sec

### 7.5.7 Alarm output method TMH2/4 TMHE

Set relay format for alarm output.

- N.O.(Normally Open): At normal status, relay is open. When alarm occurs, it is closed.
- N.C.(Normally Closed): At normal status, relay is closed. When alarm occurs, it is open.

Setting group	Parameter	Set range	Factory default	Unit
Event Setting	Alarm NO/NC	0: NO, 1: NC	0: NO	-



#### Note

Front indicator operation

Setting	Occurring alarm	Alarm output	Front indicator operation
N.O.	OFF	Open	<input type="checkbox"/> OFF
	ON	Close	<input checked="" type="checkbox"/> ON
N.C.	OFF	Close	<input type="checkbox"/> OFF
	ON	Open	<input checked="" type="checkbox"/> ON

### 7.5.8 Alarm output target address TMH2/4

Set alarm output target module address.

Setting group	Parameter	Set range	Factory default	Unit
Event Setting	Alarm Output Target	00, 49 to 64	00	-

For using TMH2 built-in alarm output, set the address by communication address switch setting as '0'.

Set the address by communication address switch setting of TMHE communication address as below.

Module	SW															
	0	1	2	3	4	5	6	7	8	9	A	B	C	D	E	F
TMHE	64	49	50	51	52	53	54	55	56	57	58	59	60	61	62	63

### 7.5.9 Alarm output target channel TMH2/4

Set alarm output target.

Setting group	Parameter	Set range	Factory default	Unit
Event Setting	Event Output Target Ch	0: Alarm 1 to 7: Alarm 8	0: Alarm 1	-



#### Note

For TMH2 heating&cooling control, alarm 1, and alarm 2 executes for cooling control output. It does not set as alarm output.

### 7.5.10 Alarm output logic operation TMH2 TMHE

Select alarm output logic operation (OR/AND).

Setting group	Parameter	Set range	Factory default	Unit
Common	Alarm Logic	0: OR, 1: AND	0: OR	-



#### Note

This parameter is settable only when TMH2 and using built-in alarm output (alarm output target address: 00).

**7.5.11 Loop break alarm(LBA) TMH2/4**

Diagnoses the control loop by monitoring the control subject's temperature changes and sends out alarms if necessary.

- Loop break alarm ON conditions: For heating control, heating&cooling control and control output 100% MV or MV high-limit value(MV high limit), when PV does not increase over LBA detection band (LBA Band) during LBA monitoring time (LBA Time), or when PV does not decrease below LBA detection band (LBA Band) during control output MV is 0% or MV low-limit value(MV low limit) during LBA monitoring time(LBA Time).
- Loop break alarm ON conditions: For cooling control, and control output 0% MV or MV low-limit value(MV low limit), when PV does not increase over LBA detection band (LBA Band) during LBA monitoring time (LBA Time), or when PV does not decrease below LBA detection band (LBA Band) during control output MV is 100% or MV low-limit value(MV low limit) during LBA monitoring time(LBA Time).

Common causes of LBA output ON

- Sensor error (disconnection, short)
- External controller error (magnet, auxiliary relay, etc.)
- External load error (heater, cooler, etc.)
- Misconnections and disconnections of external network.

If it is not as sensor break/HHHH/LLLL, during auto-tuning/manual control/control STOP/ramp function operation, loop break alarm does not operate.

Type	LBA monitoring time	Alarm output	
		Standard alarm	Alarm latch
Alarm reset, changing control output operation mode, setting LBA monitoring time/detection band as 0	Reset	OFF	OFF
Changing input correction value, SV		Maintains present alarm status	Maintains present alarm status
Changing MV, stopping control, running auto-tuning		OFF	Maintains present alarm status
Occurring sensor break alarm, HHHH, LLLL		ON	ON



**Note**

Set alarm output operation mode (Alarm Mode) as loop break alarm(LBA) and you can use loop breake alarm.

When executing auto-tuning, LBA detection band (LBA Band) and LBA monitoring time(LBA Time) is automatically set based on auto-tuning value.

In case of auto-tuning/manual control/control stop, LBA does not operate. When alarm reset input, starting point of LBA monitoring is reset.

### 7.5.11.1 LBA monitoring time

You can set the LBA monitoring time to check changes in the control subject's temperature. Automatically setting with auto-tuning.

- Regardless of alarm operation (including LBA monitoring time as "0"), after running auto-tuning, the integration time×2 value is saved automatically.  
(If SV is out of the range of auto setting, it is set as max. or min. value of auto setting.)
- It maintains the present SV except changing input type, re-running auto-tuning, LBA monitoring time manual setting.
- Auto setting range: 0020 to 9999

Setting group	Parameter	Set range	Factory default	Unit
Event Setting	LBA Time	0000 to 9999	0	Sec

### 7.5.11.2 LBA detection band

You can set the minimum value of deviation change to decrease during LBA monitoring time. Automatically setting with auto-tuning.

- Regardless of alarm output operation mode (Alarm Mode) (including LBA monitoring time "0"), integral time×2 is saved automatically after auto-tuning.  
(when set value is out of auto setting range, it set max./min. value of auto setting range.)
- Set value maintains except input type changing, auto-tuning reply, LBA monitoring time manual setting.
- Auto setting range  
Temperature L: 20 to 1000 (2.0 to 100.0°C/°F)  
Temperature H: 0002 to 010.0 (°C/°F)  
Analog: 2 to 100(0.2 to 10.0%F.S)

Setting group	Parameter	Set range	Factory default	Unit
Event Setting	LBA Band	Temperature H	0 to 999	°C/°F
		Temperature L	0 to 9999 (0.0 to 999.9)	
		Analog	0 to 1000 (0.0 to 100.0)	%F.S.





Ex.

For heating control(cooling control), when control output MV is 100%(0% for cooling control) and PV is not increased over than LBA detection band (LBA Band) during LBA monitoring time (LBA Time), or when control output MV is 0%(100% for cooling control) and PV is not decreased below than LBA detection band (LBA Band) during LBA monitoring time (LBA Time), alarm output turns ON.

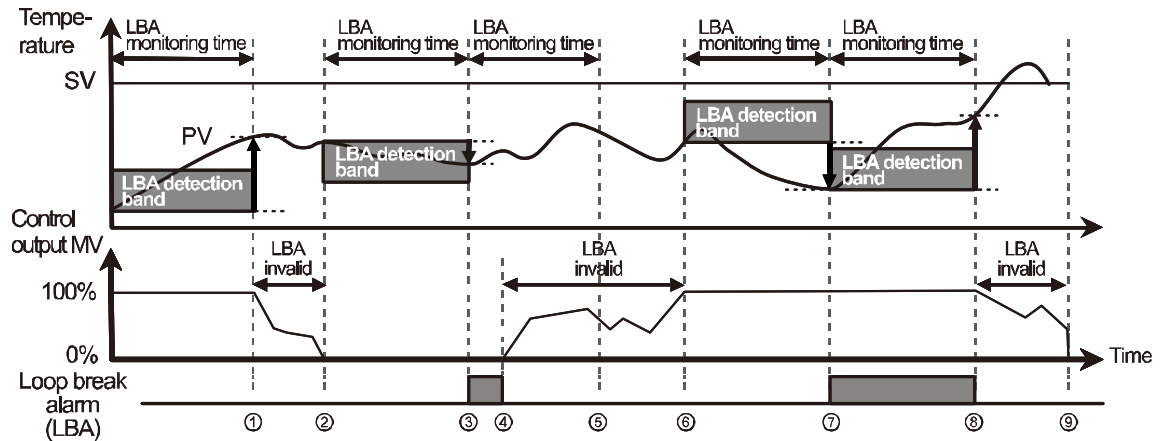

Control start to ①	When control output MV is 100%, PV is increased over than LBA detection band [L b A.b] during LBA monitoring time (LBA Time).
① to ②	The status of changing control output MV (LBA monitoring time is reset.)
② to ③	When control output MV is 0% and PV is not decreased below than LBA detection band (LBA Band) during LBA monitoring time (LBA Time), loop break alarm (LBA) turns ON after LBA monitoring time (LBA Time).
③ to ④	Control output MV is 0% and loop break alarm (LBA) turns and maintains ON.
④ to ⑥	The status of changing control output MV (LBA monitoring time is reset.)
⑥ to ⑦	When control output MV is 100% and PV is not increased over than LBA detection band(LBA Band) during LBA monitoring time (LBA Time), loop break alarm (LBA) turns ON after LBA monitoring time (LBA Time).
⑦ to ⑧	When control output MV is 100% and PV is increased over than LBA detection band (LBA Band) during LBA monitoring time (LBA Time), loop break alarm (LBA) turns OFF after LBA monitoring time (LBA Time).
⑧ to ⑨	The status of changing control output MV (LBA monitoring time is reset.)

### 7.5.12 **Sensor break alarm** TMH2/4

You can set the controller to send out an alarm when a sensor is not connected or disconnected during temperature control.

Sensor break can be confirmed through an external alarm output contact, such as a buzzer or similar means.

Setting alarm output mode(Alarm Mode) as SBA will activate sensor break alarm.



#### Note

Alarm output option can be set to standard alarm(AL-A), or alarm latch(AL-B).

### 7.5.13 **Heater break alarm** TMH2/4

When using a heater to raise the temperature of the control subject, the temperature controller can be set to detect heater disconnection and send out an alarm by monitoring power supply to the heater.

Heater disconnection is detected by the controller using a current transformer (CT), which converts the current to the heater to a specific ratio (CT ratio, 1000:1) for monitoring. If the heater current value (CT-A) measured by the CT is less than the heater detection set value (Alarm Low\_CH), the heater break alarm will activate.

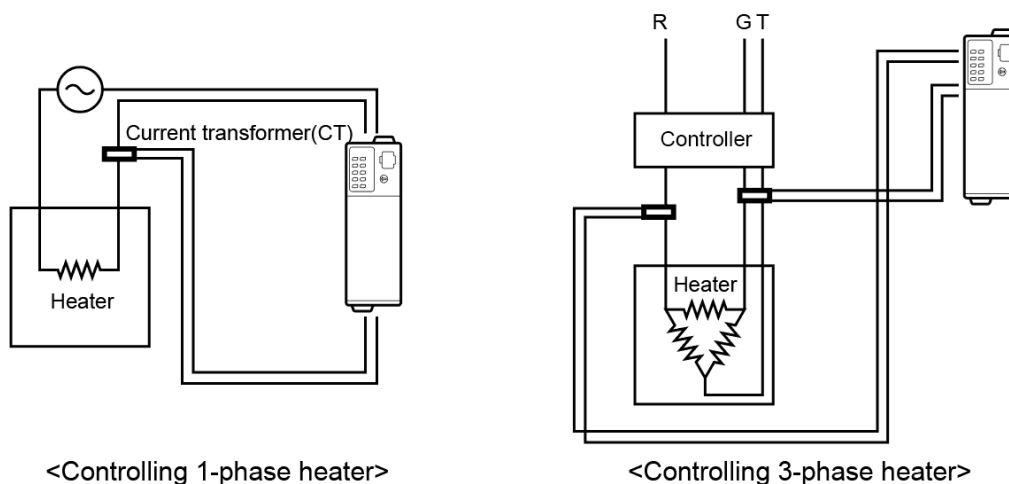

Select the module address and CT terminal no. for connecting CT using heat break alarm.

In this case CT which is connected the same address module is available. When CT input additionally is required for 3-phase load, etc, use the CT input option module(TMHCCT).

One channel is available to set total 4 alarms (Event 1 to 4). For using 3-phase load, set two events as heater break alarm for 3-phase heater break detection.



#### Note

- When control output of temperature controller turns ON, heater break detection executes. When it turns OFF, it does not detect even though heater break.
- It is available only for Relay, SSR drive output models not for the current output model.
- When control output ON time is min. 250ms (1 sec. for TMHCCT module), it does not detect current.
- It is recommended to use the dedicated Autonics current transformer (CT).
- Alarm output option is selectable among standard alarm (AL-A), alarm latch (AL-B).

### 7.5.13.1 CT address

Set the module address which has connected CT for heater break alarm.

Setting group	Parameter	Set range	Factory default	Unit
Event Setting	CT Target	0, 65 to 80	0	-

For using the CT of TMH2/4, set the address as '0'.

Set the address by communication address switch setting of TMHCT communication address as below.

SW Module																
	0	1	2	3	4	5	6	7	8	9	A	B	C	D	E	F
TMHCT	80	65	66	67	68	69	70	71	72	73	74	75	76	77	78	79

### 7.5.13.2 CT input

Set CT input for heater break alarm.

Setting group	Parameter	Set range		Factory default	Unit
Event Setting	CT Input	TMH2	0: CT1 to 3: CT4	CH1: CT1	-
		TMH4	0: CT1 to 3: CT4		
		TMHCT	0: CT1 to 7: CT8		

### 7.5.13.3 Heater break detection set value

Set the alarm output value (Alarm Low\_Ch) as the reference value for heater break detection.

Set value calculation

: Heater break detection set value = {(Heater current value for normal operation) + (Heater current value for heater break)}/2

Setting group	Parameter	Set range	Factory default	Unit
Event Setting	Alarm Low	0(OFF), 1 to 500 (0.1 to 50.0)	0 (OFF)	A

 Ex.

- For operating 1-phase 1 heater unit (heater capacity: 200VAC, 1Kw, 5A), normal operation heater current value is 5A, and heater break current value is 0A. The set value is  $(5A + 0A)/2 = 2.5A$ . When the measured heater current value is below the set value 2.5A for heater break detection, it considers heater break and alarm outputs.

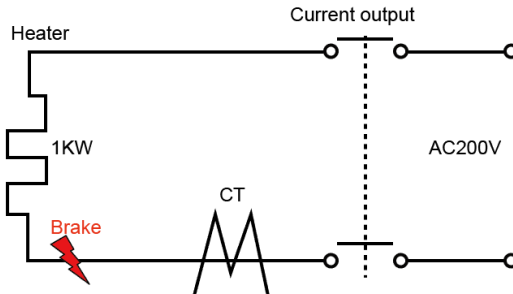

- For operating 1-phase 2 heater units (heater capacity: 200VAC, 1Kw, 5A), normal operation heater current value is 10A( $5A \times 2$  units), and, if one heater break, heater current value is 5A. The set value is  $(10A + 5A)/2 = 7.5A$ . When the measured heater current value is below the set value 7.5A for heater break detection, it considers heater break and alarm outputs.

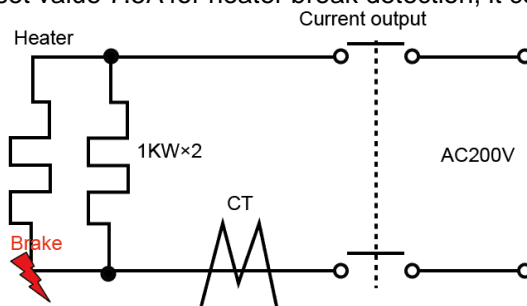

- For operating 3-phase 1 heater unit (heater capacity: 200VAC, 2Kw, 10A) with delta connection, normal operation heater current value is  $17.3A(\sqrt{3} \times 10A)$ .

When heater breaks as below, min. heater current value is  $10A \times \sqrt{3} \times \frac{\sqrt{3}}{2} = 15A$  .

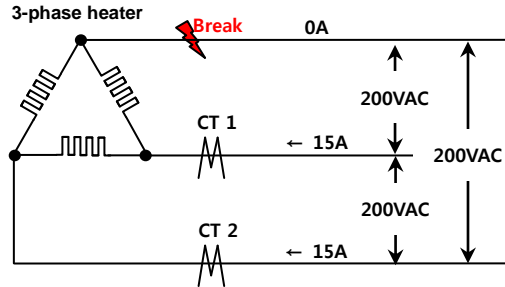

When heater breaks as below, min. heater current value is  $10A \times \sqrt{3} \times \frac{1}{\sqrt{3}} = 10A$ .

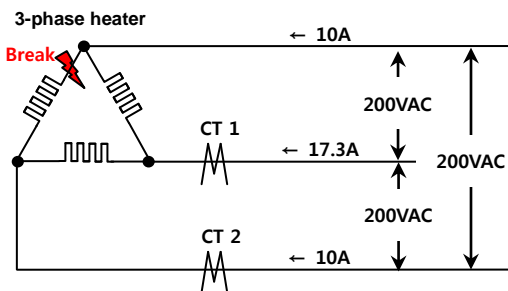

In these cases, the set values (normal operation heater current value +heater break heater current value)/2 are  $(17.3+15)/2=16.1A$ ,  $(17.3+10)/2=13.65A$  and set as 16.1A. When the measured heater current value is below the set value 16.1A for heater break detection, it considers heater break and alarm outputs.

- For operating 3-phase 1 heater unit (heater capacity: 200VAC, 2Kw, 10A) with star connection, normal operation heater current value is  $5.8A(1/\sqrt{3} \times 10A)$ .

When heater breaks as below, min. heater current value is  $10A \times \frac{1}{\sqrt{3}} \times \frac{\sqrt{3}}{2} = 5A$ .

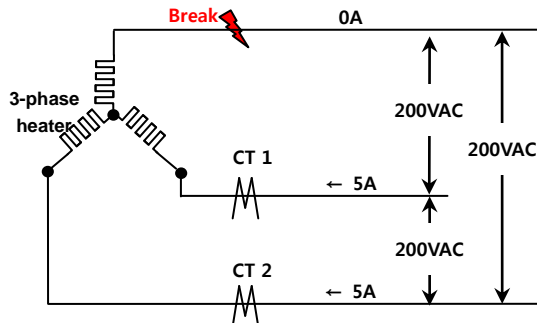

When heater breaks as below, min. heater current value is  $10A \times \frac{1}{\sqrt{3}} \times \frac{\sqrt{3}}{2} = 5A$ .

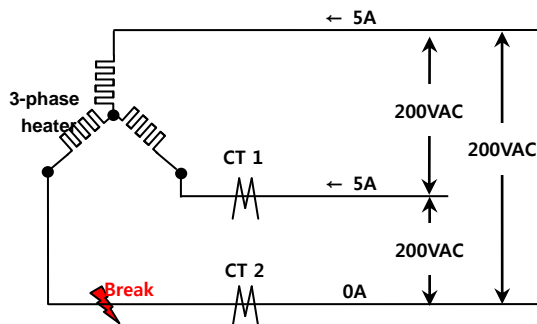

In these cases, the set values (normal operation heater current value + heater break heater current value)/2 are  $(5.8+5)/2=5.4A$  and set as 5.4A. When the measured heater current value is below the set value 5.4A for heater break detection, it considers heater break and alarm outputs.

- For operating 3-phase 1 heater unit (heater capacity: 200VAC, 2Kw, 10A) with V connection, normal operation heater current value is 10A. When heater breaks as below, min. heater current value is  $10A \times \frac{1}{2} = 5A$ .

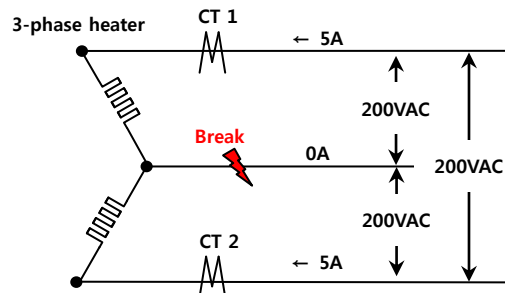

When heater breaks as below, min. heater current value is 0A.

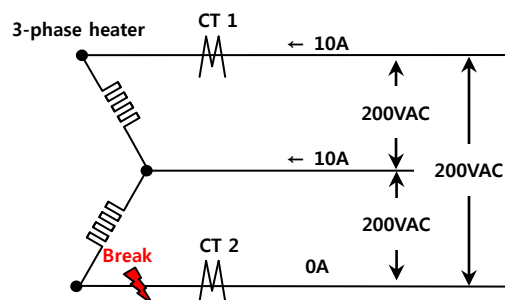

In these cases, the set values (normal operation heater current value + heater break heater current value) / 2 are  $(10+5)/2=7.5A$ ,  $(10+0)/2=5A$  and set as 7.5A. When the measured heater current value is below the set value 7.5A for heater break detection, it considers heater break and alarm outputs.

**7.5.14 Alarm output deactivation** TMH2/4

Available only if alarm output option is set to alarm latch or alarm latch and standby sequence1, alarm latch and standby sequence2. It can be set to turn OFF alarm output when alarm output is ON, alarm output conditions have been removed, or an alarm output deactivation signal that is greater than the minimal signal band is received. (However, alarm output deactivation is unavailable when alarm conditions remain in effect.)

Digital input terminal is available to use alarm output deactivation function.

 **Note**

- For detailed information on digital input terminal (DI), refer to 7.10 Digital input TMH2/4.
- After deactivating the alarm output, it will function normally for the next alarm output occurrence.

**7.5.15 Operation example for alarm output**

**(1) Absolute value high-limit alarm, Deviation high-limit alarm**

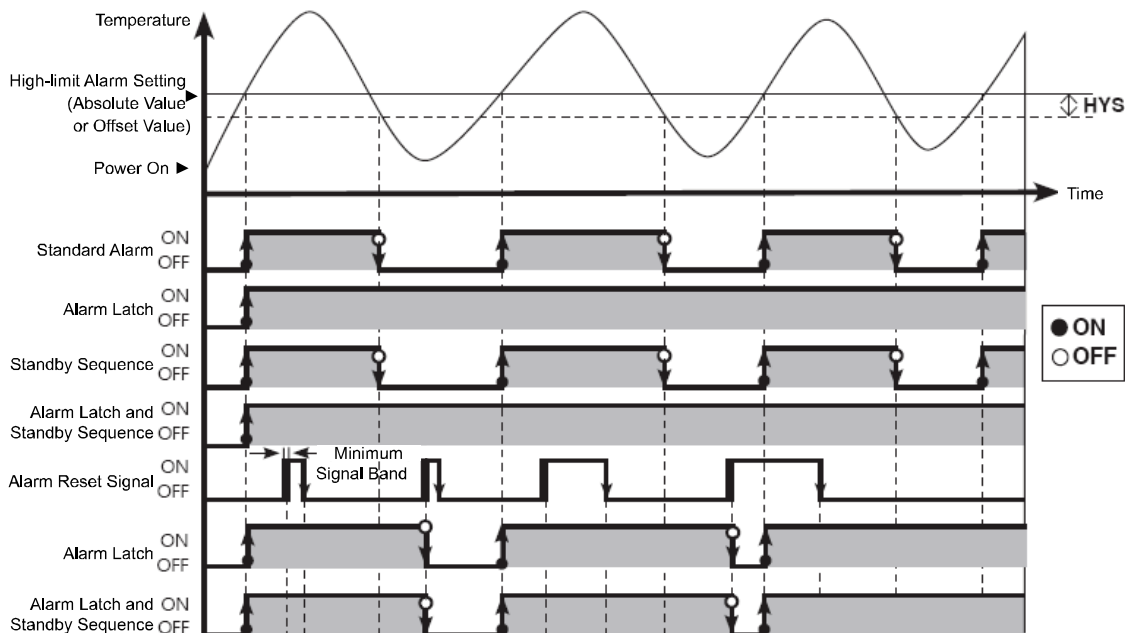

※HYS: hysteresis



**(2) Absolute value low-limit alarm, Deviation low-limit alarm**

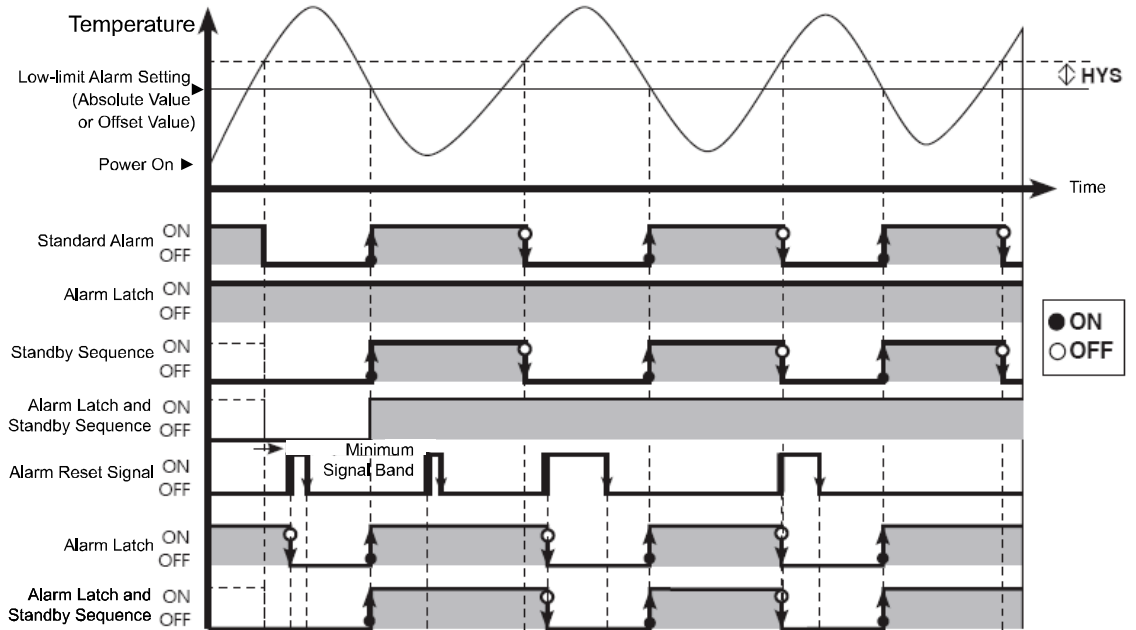

※HYS: hysteresis

**(3) Deviation highlow-limit alarm**

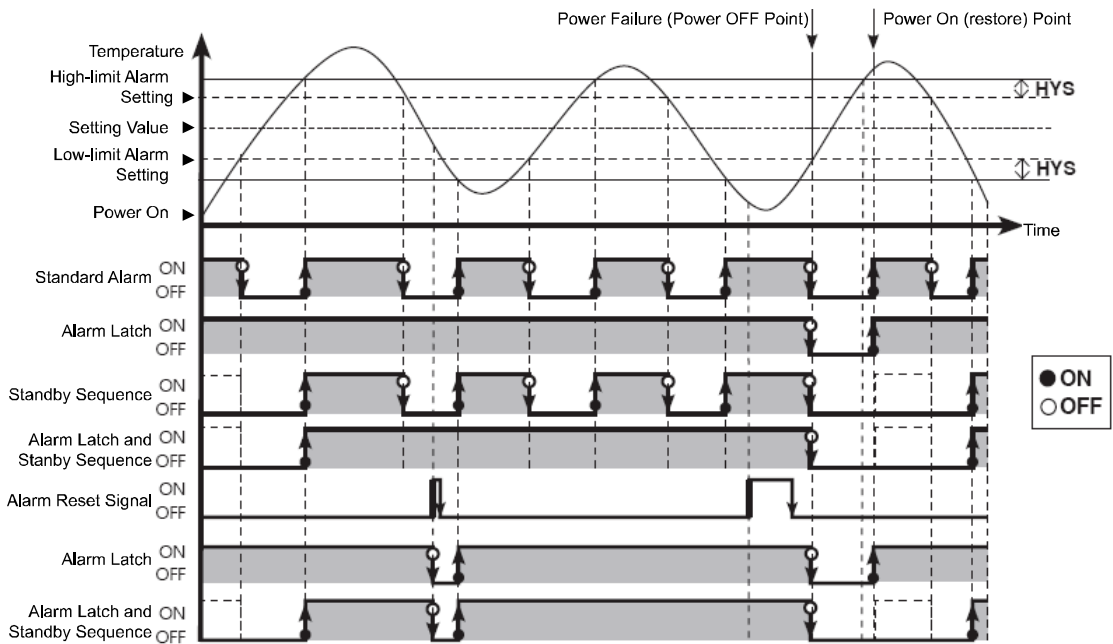

※HYS: hysteresis

**(4) Deviation highlow-limit reverse alarm**

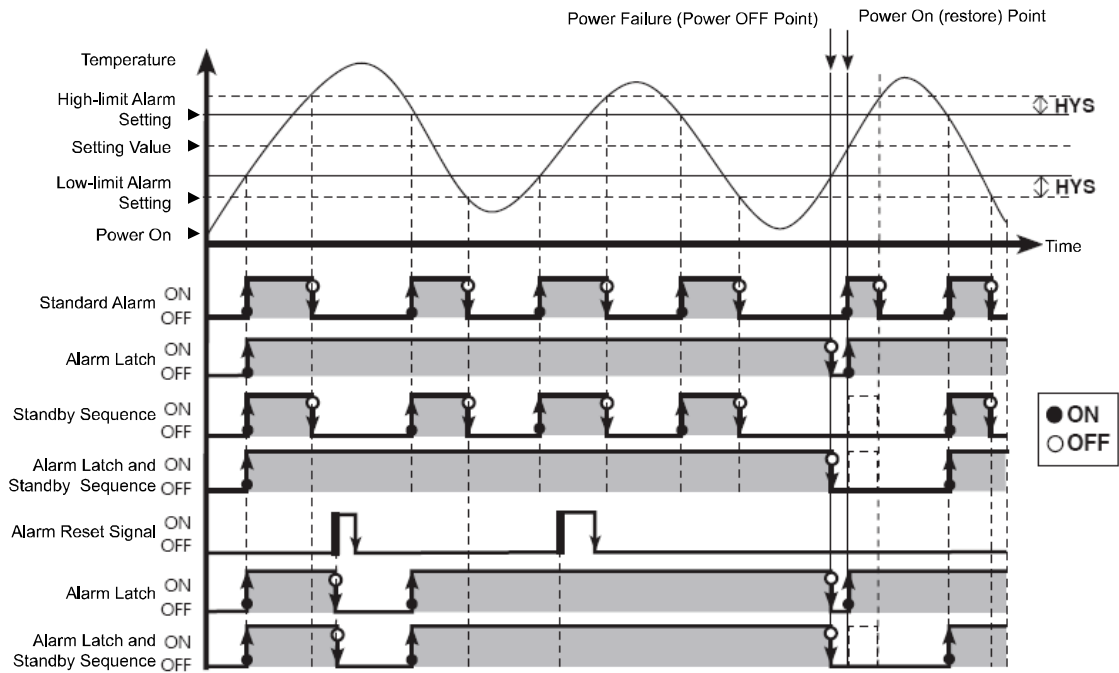

※HYS: hysteresis

**(5) Deviation highlow-limit alarm(hysteresis is duplicated)**

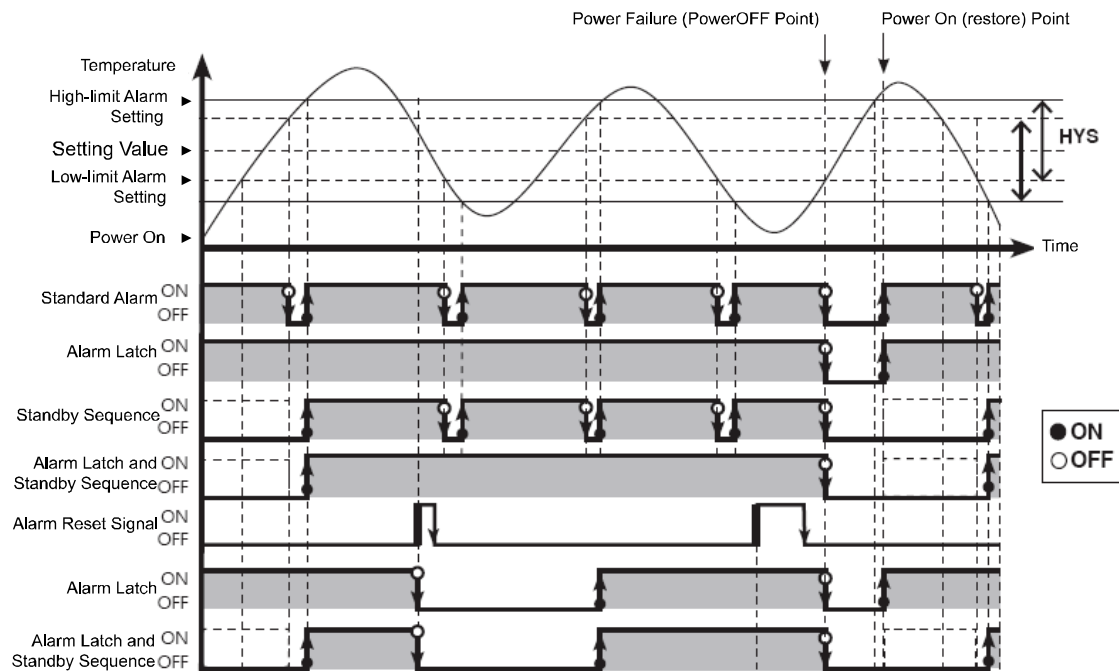

※HYS: hysteresis

## 7.6 **Communication** TMH2/4 TMHA TMHE TMHCT TMHC

This feature is used for external higher systems (PC, GP, etc.) to set the controller's parameters and to monitor the controller. It can also be used to external devices.

In case of TMHC, set COM1/2. (communication cable is recommended to use twisted pair wire for RS485 communication.)



### ■ Interface

Communication protocol		Modbus RTU
Connection type		RS485, RS422 (RS422, TMHC only)
Max. connections	TMH2/4	32 units (address: 01 to 32) (however, connecting with TMHC option module, 16 units (address: 01 to 16))
	TMHA/TMHE/TMHCT/TMHC	Each module 16 units
Synchronous method		Asynchronous
Communication method		2-wire half duplex
Communication effective range		Max. 800m
Communication speed		4800, 9600(factory default), 19200, 38400, 195200 bps
Communication response wait time		5 to 99ms (factory default: 20ms)
Start bit		1bit (fixed)
Data bit		8bit (fixed)
Parity bit		None (factory default), Odd, Even
Stop bit		1bit, 2bit (factory default)

### 7.6.1 **Communication address**

You can assign a unique address to each device.

In case of TMH2/4, users can set communication address using both SW1 (communication address setting switch) and SW2 (communication group change switch).

Module	SW																
		0	1	2	3	4	5	6	7	8	9	A	B	C	D	E	F
TMH4/2	 +0 +16	16	01	02	03	04	05	06	07	08	09	10	11	12	13	14	15
	 +0 +16	32	17	18	19	20	21	22	23	24	25	26	27	28	29	30	31
TMHC		16	01	02	03	04	05	06	07	08	09	10	11	12	13	14	15
TMHA		48	33	34	35	36	37	38	39	40	41	42	43	44	45	46	47
TMHE		64	49	50	51	52	53	54	55	56	57	58	59	60	61	62	63
TMHCT		80	65	66	67	68	69	70	71	72	73	74	75	76	77	78	79



### Note

Each module should be have individual address. If there is duplicated address, the monitoring of the modules are not available and total communication speed may be slow down.

When using TMHC, in case connecting only TMHC to Master (PC, PLC, etc.), communication address of TMHC and TMH2/4 Series control module can be duplicated. However, in case connecting both TMHC and TMH2/4 Series control module to Master, communication address

must not be duplicated. (If the TMHC and TMH modules communicate to Master at the same time, a communication error may occur.)

### 7.6.2 **Communication speed**

You can set the rate of data transmission.

Setting group	Parameter	Set range	Factory default	Unit
Common	Bit Per Second	0: 4800, 1: 9600, 2: 19200, 3: 38400, 4: 115200	1: 9600	bps



#### Note

- When supplying power to the module, the dedicated indicator for set communication speed flashes for 5 sec in every sec. Refer to '1.4 Unit description and function'.
- It is required to reset controller's POWER (Power OFF -> Power ON) after changing communication speed (bps) via Power/Comm. connection terminal.
- One module communication is allowed for PC loader port. Communication speed is fixed to 9600 bps.

### 7.6.3 **Communication parity bit**

Parity bit is a data communication method that adds an additional bit to each character in transmitted data as an indicator used to verify data loss and corruption. This parameter is used to enable or disable the parity bit option.

Setting group	Parameter	Set range	Factory default	Unit
Common	Parity Bit	0: NONE, 1: EVEN, 2: ODD	0: NONE	-

Set value	Description
NONE	Disables parity bit.
EVEN	Sets the total bits with signal value of 1 as even numbers.
ODD	Sets the total bits with signal value of 1 as odd numbers.

### 7.6.4 **Communication stop bit**

You can set the number of bits to mark the end of a transmitted data string.

Setting group	Parameter	Set range	Factory default	Unit
Common	Stop Bit	0: 1 Bit, 1: 2 Bit	1: 2 Bit	-

Set value	Description
1 Bit	Sets end of data string to 1 bit.
2 Bit	Sets end of data string to 2 bit.

### 7.6.5 **Communication response wait time**

Set a standby time to mitigate communication errors when communicating with a slow master device (PC, PLC, etc.). Once a standby time is set, the controller will respond after the defined standby time has elapsed.

Setting group	Parameter	Set range	Factory default	Unit
Communication Setting	Response Waiting Time	5 to 99	20	ms



#### Note

Shorter standby times can cause communication errors in the master device.

### 7.6.6 **Enable/Disable communications writing**

This feature can change parameter settings stored in memory through communication with PC, GP, PLC, etc., in order to permit or prohibit writing.

Setting group	Parameter	Set range	Factory default	Unit
Communication Setting	Communication Write	ENABLE, DISABLE	ENABLE	-

Set value	Description
ENABLE	Parameter set/change enable via communication.
DISABLE	Prohibit parameter setting or modification via communication.



#### Note

Reading parameter settings is always permitted.

### 7.6.7 USB to Serial communication connection

Data can be transmitted via a USB-to-serial connection. However, RS485 communication through a USB-to-serial connection is blocked by hardware.

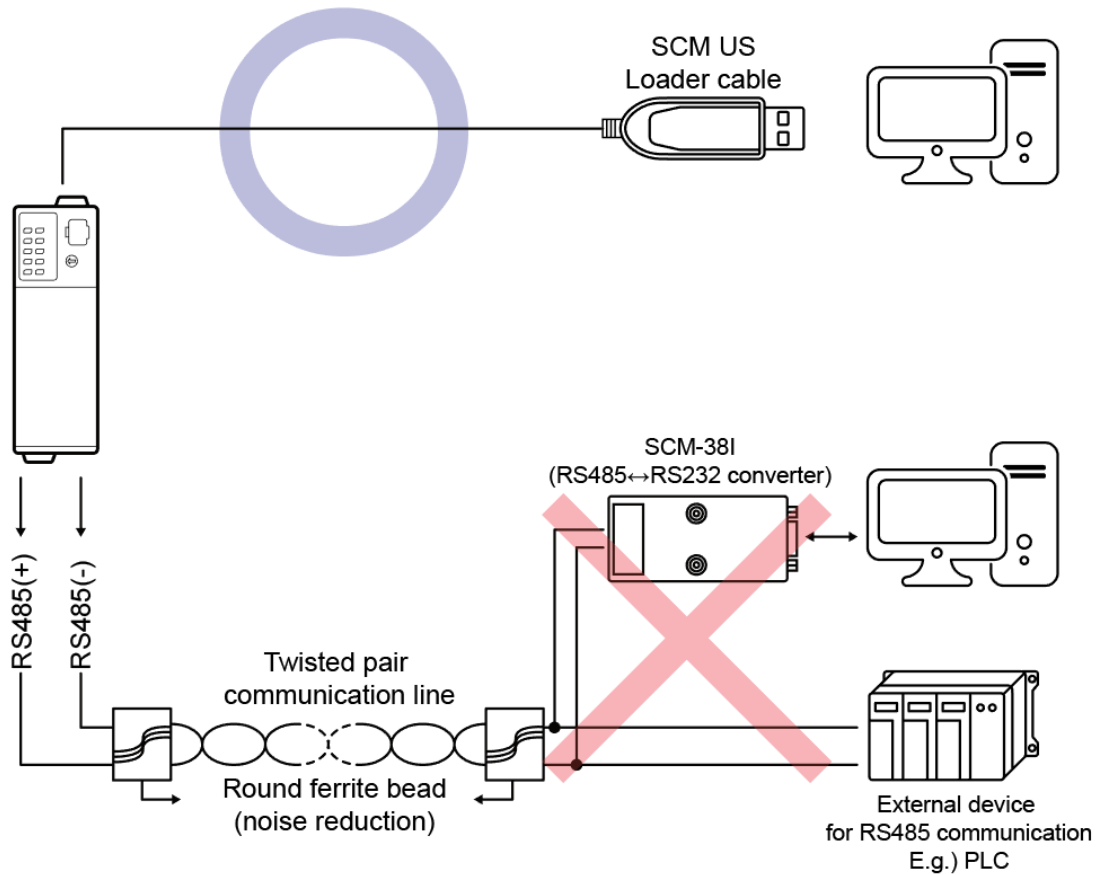

## 7.7 Monitoring

### 7.7.1 Control output MV monitoring TMH2/4

Monitors and displays the present control output MV.

### 7.7.2 Heating MV monitoring TMH2/4

Displays the current heating MV during heating control or heating and cooling control. Users may manually adjust the MV to control the temperature.

Setting group	Parameter	Display range	Factory default	Unit
Monitoring	Heating_MV	0 to 1000(0.0 to 100.0)	-	%

### 7.7.3 Cooling MV monitoring TMH2/4

Displays the current cooling MV during cooling control or heating and cooling control. Users may manually adjust the MV to control the temperature.

Setting group	Parameter	Display range	Factory default	Unit
Monitoring	Cooling_MV	0 to 1000(0.0 to 100.0)	-	%

### 7.7.4 Heater current value monitoring TMH2/4

A feature that monitors and displays the current of a heater (load) being controlled by control output.

Setting group	Parameter	Display range	Factory default	Unit
-	CT1/2/3/4_Heater Current	0 to 500(0.0 to 50.0)	-	A



#### Note

The current value of a heater (load) is measured and displayed through the current transformer.

















### 7.7.5 **CT input value monitoring** TMHCT

Displays the measured current value via current transformer (CT) by each CT input terminal.

Setting group	Parameter	Display range	Factory default	Unit
-	CT1/2/3/4/5/6/7/8_Heater Current	0.0 to 50.0	-	A

### 7.7.6 **CT input value indicators channel** TMHCT

The indicator of TMHCT turns ON by the input value of CT.

Indicator	Status	CT input
LED 1 LED 2	PWR (green)	ON
 	(red)	ON (40.1 to 50.0A)
PWR	(red)	ON (30.1 to 40.0A)
 	(red)	ON (20.1 to 30.0A)
 	(red)	ON (10.1 to 20.0A)
 	(yellow)	—
 	(yellow)	ON (40.1 to 50.0A)
 	(yellow)	ON (30.1 to 40.0A)
 	(yellow)	ON (20.1 to 30.0A)
 	(yellow)	ON (10.1 to 20.0A)

Set at LED 1: CT Input Value Indication Lamp1 / LED 2: CT Input Value Indication Lamp2.

Setting group	Parameter	Set range	Factory default	Unit
Common	CT Input Value Indication Lamp1	0: CT1, 1: CT2, 2: CT3, 3: CT4,	0: CT1	-
	CT Input Value Indication Lamp2	4: CT5, 5: CT6, 6: CT7, 7: CT8	1: CT2	-



## 7.8 **RUN/STOP** TMH2/4

Users may run or stop control output by force while in Run mode.

The STOP command stops the control output. Alarm output, other than control output, maintains the values as set in the alarm output setting at the point of STOP.

This feature can be enabled by configuring parameters. The digital input terminals (TMH DI-1, DI-2 or TMHE) can be assigned to the run/stop feature.



### Note

- Modifications on RUN/STOP are allowed even when in open state. The STOP status will remain in effect after shutting down the controller and powering it back on.
- When STOP is in effect, MV based on the control output at the point of STOP (Stop.MV) is displayed, and continues to be displayed even if a sensor break occurs.
- The run/stop setting remains in effect after turning power back on.

### 7.8.1 **STOP, Control output**

This sets the control output value upon a STOP. With ON/OFF control, select between 0.0 (OFF) and 100.0 (ON). In PID control, you can directly choose MV within a range of 0.0 to 100.0.

Setting group	Parameter	Set range			Factory default	Unit
Control Setting	Stop MV	Heating, Cooling	PID	0 to 1000 (0.0 to 100.0)	0(0.0)	%
			ON/OFF	0/1000 (0.0/100.0)		
		Heating & Cooling	PID-PID	-1000 to 1000 (-100.0 to 100.0)		
			PID-ON/OFF	-1000(-100.0), 0 to 1000(0.0 to 100.0)		
			ON/OFF-PID	-1000 to 0(-100.0 to 0.0), 1000(100.0)		
			ON/OFF-ON/OFF	-1000/0/1000 (-100.0/0.0/100.0)		



### Note

- When set to STOP, the preset MV is used for output ignoring the MVs from ON/OFF control and PID control.
- For heating&cooling control, cooling MV is set as -.

### 7.8.2 **STOP, Alarm output**

Enable or disable alarm output upon a stop.

- CONTINUE: Alarm output operates normally.
- OFF: Alarm output ceases along with a stop under all conditions. (However, reverting to Run mode after a stop in alarm latch or alarm latch and standby sequence restores the alarm output to the previous state.)

Setting group	Parameter	Set range	Factory default	Unit
Control Setting	Stop Alarm Out	0: CONTINUE, 1: OFF	0: CONTINUE	-

## 7.9 **Multi SV** TMH2/4

Multi SV function allows users to set multiple SVs and save each setting in SV0 to SV3. User can change Multi SV number or select desired SV using external DI (Digital Input, DI-1, DI-2) terminal.

This feature supports up to four SVs which can be independently configurable.

### 7.9.1 **Number of multi SVs**

You can set the number of Multi SVs. Select the number of Multi SVs from the controlled subject.

Setting group	Parameter	Set range	Factory default	Unit
Operating	Multi SV	0: 1EA, 1: 2EA, 2: 4EA	0: 1EA	-

Set value	Number of multi SVs
1 EA	SV-0
2 EA	SV-0, SV-1
4 EA	SV-0, SV-1, SV-2, SV-3,

### 7.9.2 **Multi SV No.**

You can select the SV to desired control. The SV No. selection range varies according to the number of multi SVs.

Setting group	Parameter	Set range	Factory default	Unit
Operating (Control operation)	Multi SV No	0: SV-0, 1: SV-1, 2: SV-2, 3: SV-3	0: SV-0	-



#### Note

When setting digital input as Multi SV, Multi SV No. parameter does not set by communication. The set value is changed by digital input terminal input.

### 7.9.3 **Multi SV**

Designate the value of each SV for Multi SVs.

Setting group	Parameter	Set range	Factory default	Unit
Operating (Control operation)	SV-0 to SV-3	SV low limit to SV high limit	0	temperature: °C, °F analog: Digit

## 7.10 Digital input TMH2/4

### 7.10.1 Digital input target address

Set module address for receiving digital input signal.

Setting group	Parameter	Set range	Factory default	Unit
Option Setting (Digital input setting)	DI Target	0, 49 to 64	0	-

When setting as '0', TMH2 uses internal digital input and TMH4 does not use digital input.

Set the address by communication address switch setting of TMHE as below.

Module	SW 															
	0	1	2	3	4	5	6	7	8	9	A	B	C	D	E	F
TMHE	64	49	50	51	52	53	54	55	56	57	58	59	60	61	62	63

### 7.10.2 Digital input terminal

When send the signal to the external digital input terminal, the settings of the digital input

\_Func parameter will perform. When powers on, it will activate after checking the digital input terminal.

Setting group	Parameter	Set range	Factory default	Unit
Digital Input Setting	Digital Input 1/2/3/4/5/6/7/8 Func	0: OFF, 1: STOP, 2: AL-RESET 3: Manual, 4: Multi-SV 5: Remote SV	0: OFF	-

Set value	Description
OFF	No function.
STOP	If the digital input terminal is shorted, the stop feature will perform, but to change run/stop through communication will not perform.
AL-RESET	If digital input terminal is shorted, the forced deactivation of alarm output will perform, but to deactivate the alarm output through communication will not perform.
Manual	If digital input terminal is shorted, the manual control feature will perform, but to change auto/manual control through communication will not perform.
Multi-SV	By combinational logic of the digital input, it is possible to select multi SV NO. (SV-0 to SV-3), but it is not possible to select multi SV NO. through communication.
Remote SV	If digital input terminal is shorted, the remote SV feature will be on and the terminal is opened, it will be off. To change RSV function parameter through communication will perform.



#### Note

- If digital input terminals setting are same, it operates at OR condition and releasing is at AND condition. (except Multi-SV)
- When operating digital input terminals at the same time, it operates as the priority of control operation.

- For AL-RESET function, it operates by rising edge signal of terminal input. If setting is duplicated, it operates sequentially by terminal input signal order.
- Multi SV(Multi-SV) is selectable only at digital input 1/2.
- In the case one of DI-1 or DI-2 being set for Multi SV, SV-0 is selected as the SV if the terminal's external contact signal is off and SV-1 is selected if the signal is on.
- If both DI-1 and DI-2 are configured for Multi SV, you can select the SV using combinational logic of the terminals. If changes multi SV from 4 to 2, the DI-2 will be automatically turned off. If changes multi SV from 4 to 1, both DI-1 and DI-2 will be turned off.

DI-1	DI-2	Multi SV NO
OFF	OFF	SV-0
ON	OFF	SV-1
OFF	ON	SV-2
ON	ON	SV-3

- Multi SV parameter will be activated only if Multi SV is more than 2.

## 7.11 **Error** TMH2/4

The controller diagnoses input signals for errors and displays messages accordingly. These messages inform the user of device problems. Once the cause of the error is solved (sensor connected/return to display range), the error status is released and the device continues to run normally.

- The following conditions may result in errors. When an error occurs, the display LED at the front flashes at 0.5 second intervals.
  - The sensor input is higher than operational temperature range.
  - The sensor input is lower than operational temperature range.
  - Input sensor is disconnected or not connected.



### Note

- When power is on, or in standard control or heating mode, the controller outputs 0% if HHHH is displayed and 100% if LLLL is displayed.
- When power is on, or in standard control or cooling mode, the controller outputs 100% if HHHH is displayed and 0% if LLLL is displayed.
- In heating and cooling mode, when power is on or in standard control, heating output is 0% and cooling output is 100% if HHHH is displayed; heating output 100% and cooling output is 0% if LLLL is displayed.
- Output priority in manual control: Heating(Cooling)\_MV > Stop\_MV > Sensor Error\_MV
- Output priority in auto control: Stop\_MV > Sensor Error\_MV > Heating(Cooling)\_MV

### 7.11.1 **Sensor error, MV**

This feature sets control output when a sensor open error occurs. Users can configure ON/OFF, MV settings, etc.

Ignores MV by ON/OFF control or PID control, and sends out a control value based on the defined MV.

Setting group	Parameter	Set range			Factory default	Unit
Control Setting	Sensor Error MV	Heating, Cooling	PID	0 to 1000 (0.0 to 100.0)	0(0.0)	%
			ON/OFF	0/1000 (0.0/100.0)		
		Heating& Cooling	PID	-1000 to 1000 (-100.0 to 100.0)		
			ON/OFF	-1000/0/1000 (-100.0/0.0/100.0)		

## 7.12 **Parameter reset** TMH2/4 TMHA TMHE TMHCT TMHC

This option resets all parameters in memory to factory defaults.

Setting group	Parameter	Set range	Factory default	Unit
Communication Setting	Parameter Initialize	YES, NO	NO	-



### Note

If selecting "Yes", all parameters will be reset and temperature control will be by factory default. However, communication parameters are not reset.

## 8 Simple Error Diagnosis

### 8.1 Error display

Indicator \ Status	Disconnected input sensors	Out of temperature range
PWR (red)	ON	
CH□ (red) <sup>※1</sup>	Flash (for 0.5 sec in turn)	
Communication output (decimal)	Outputs '31000'	Outputs '30000(high-limit)', '-30000(low-limit)'
DAQMaster	Displays 'OPEN'	Displays 'HHHH(high-limit)', 'LLLL(low-limit)'

※1. The applied CH LED indicator flashes.

### 8.2 Trouble shootings

#### (1) LED indicators flash (for 0.5 sec. in turn), or external device displays OPEN

- Check input sensor setting.
- Disconnect the power and check the input connection.
- If input is connected, disconnect the input wiring from the temperature controller and short the + and - terminals. Power the temperature controller and check if the external device displays the room temperature. If it does not display the room temperature and continues to display HHHH or LLLL, the controller is broken. Please contact our technical support. (input type is thermocouple)

#### (2) Output does not operate normally.

- Check that CH indicators for control output operates normally.
- If CH indicators for control output does not operates, check the parameter settings.
- If CH indicators for control output operates, remove the control output connector and check the output.

#### (3) External device receives no-response or abnormal data.

- Check the communication converter (SCM-38I, SCM-US48I or SCM-US, sold separately).
- Do not install communication converter line and AC power supply lines.
- Use different communication converter power and temperature controller power.
- Indicates damage to internal chip by strong noise. Please contact our technical support. Locate the source of the noise device countermeasures.

#### (4) Communication does not work between TMH and external device

- Check the communication converter power and connections.
- Check the communication settings.
- Check the temperature controller and external device connections.

# 9 Comprehensive Device Management Program (DAQMaster)

## 9.1 Overview

DAQMaster is a comprehensive device management program that can be used with Autonics communication supporting products.

DAQMaster provides GUI control for easy and convenient management of parameters and multiple device data monitoring.



### Note

For more information, visit our website ([www.autonics.com](http://www.autonics.com)) to download "DAQMaster user manual".



## 9.2 Features

### (1) DAQMaster Pro Version Feature

- Data Base  
Database managing system (Access, MySQL, SQL Server, Oracle, SQLite) turns information into database in real-time, making creation and management of database easier.
- Real-time Logging  
At the set cycle and condition, real-time log file is generated in CSV file.
- Modbus Device Editor  
You can add the any modbus devices which are not supported at DAQMaster to set and monitor the property and I/O.
- OPC Client  
It is Interface method for better compatibility among application programs based on OLE/COM and DCOM technology of Microsoft. It provides industry standard mechanism for communication and data conversion between client and server.
- DDE Client  
It supports communication (IPC) among process embedded in Microsoft Window system, allowing application programs to share and exchange information. This function uses shared memory and provides a common protocol (instruction set and message format) to application programs.

### (2) Features

- Multiple Device Support  
Simultaneously monitor multiple devices and set parameters. Simultaneously connect units with different addresses in a single device. Multiple RS-232 ports are available for communications using Modbus remote terminal unit.
- Device Scan  
In cases of multiple units (with different addresses) connected together, the unit scan function automatically searches for units.
- Convenient User Interface  
Freely arrange windows for data monitoring, properties, and projects. Saving a project also saves the screen layout.
- Project Management  
Saving data as a project file includes added device information, data monitoring screen layouts, and I/O source selection. When you open the project file, the last state of the saving moment will be loaded. Organizing project list makes managing project files easier.
- Data Analysis  
Performs grid and graph analyses of data files (\*.ddf ) using data analysis feature of DAQMaster. Saves grid data in .rtf, .txt, .html, or .csv files in Data Grid.
- Monitoring Data Log  
When monitoring, data log files can be saved in either DAQMaster data files (.ddf) or CSV (.csv) files. Open files saved in .csv format directly from Microsoft Excel. Define log data file naming/saving rules and destination folders to make file management convenient.
- Tag Calculation Editing  
Read tag value is available to calculate the set formula for the desired value.
- Print Modbus Map Table Report  
Print address map reports of registered Modbus devices. Modbus map table reports can be saved in html (\*.html) and pdf (\*.pdf) formats.
- Multilingual Support  
Supports Korean, English, Japanese, and Simplified Chinese. To add a different language, modify the files in the Lang folder rename, and save.
- Script Support  
Uses the Lua Script language and deals with different I/O processes for individual devices.

### 9.3 **Special feature for TMH Series**

Save parameter values and user parameter group is available by DAQMaster. Visit our website ([www.autonics.com](http://www.autonics.com)) to download DAQMaster software and the manual.

### 9.4 **Save parameter values**

When several same model units cannot be connected to DAQMaster at once and parameter copy is not available, you can save the setting of the device as a file and utilize the file at a later.

#### **(1) TMH2I4(control module), TMHA, TMHE, TMHCT(option module) connection**

1st Connect the TMH device which parameters are saved.

2nd Click 'Read All Parameters' of the unit device which parameters are saved or 'Read All Unit Parameters' of TMH at My System.

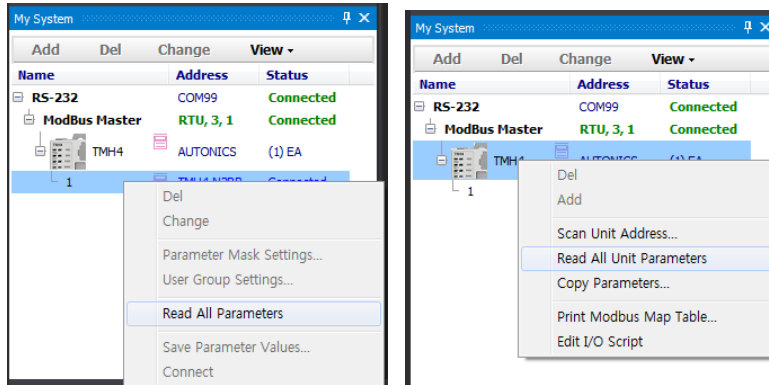

3rd Select TMH at My System and right-click to select 'Copy Parameters' and Parameter Copy dialog appears.

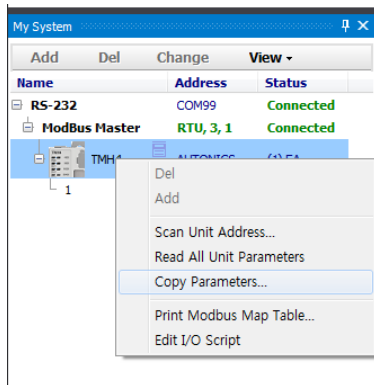

4th Right-click the unit which parameters are saved and select 'Parameter Select'. The parameter values of the unit is loaded at the right side of the dialog.

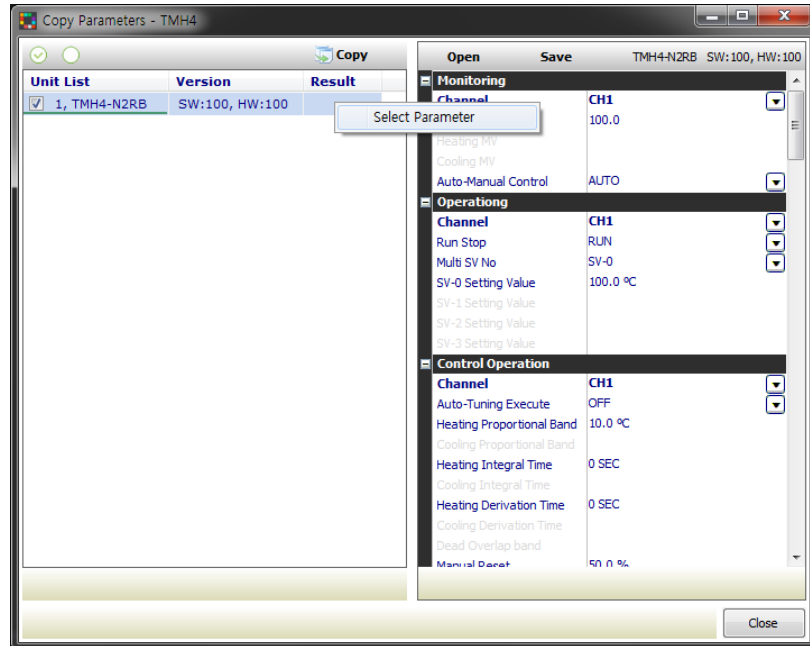

5th Click 'Save' and it saves parameters in \*.prx file.

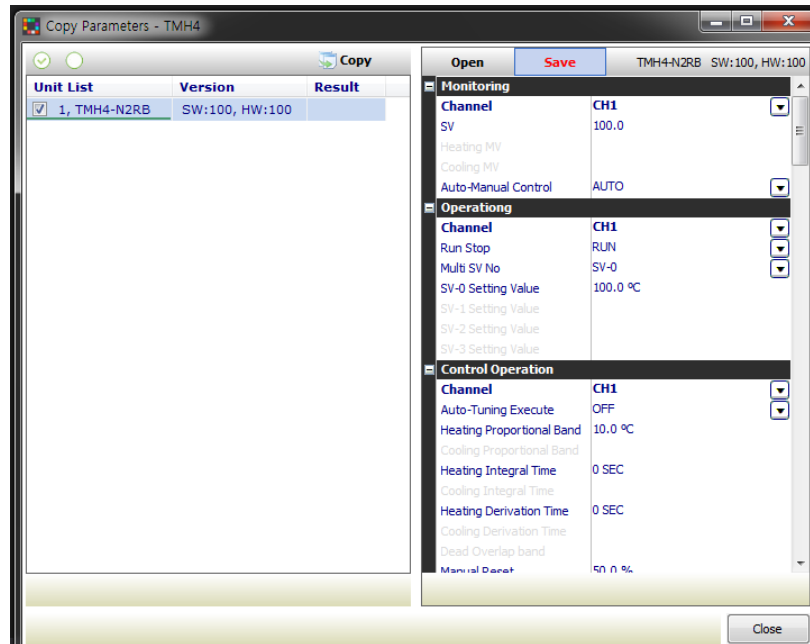

**(2) TMHC (option module) connection**

In case of TMHC (RS422/RS485 communication output option module), parameters of the connected TMH2/4(control module) and TMHA/E/CT(option module) are available to set.

- 1st Connect TMHC device which is connected with TMH2/4/A/E/CT for saving parameter as file. At DAQ Space, TMHC tab appears. Click “Scan” of the Use Module List to display the connected TMH2/4/A/E/CT device module.

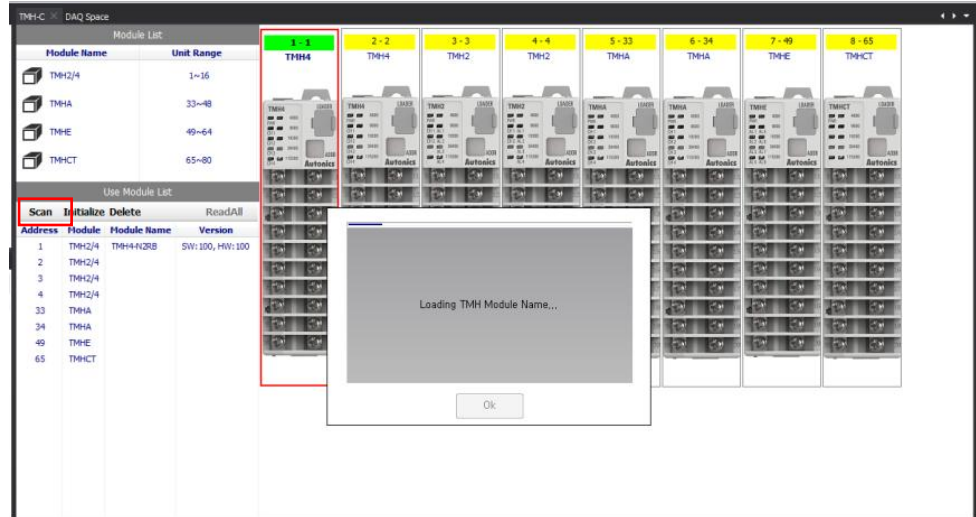

- 2nd Click “Read All” to read and display parameters of each module.

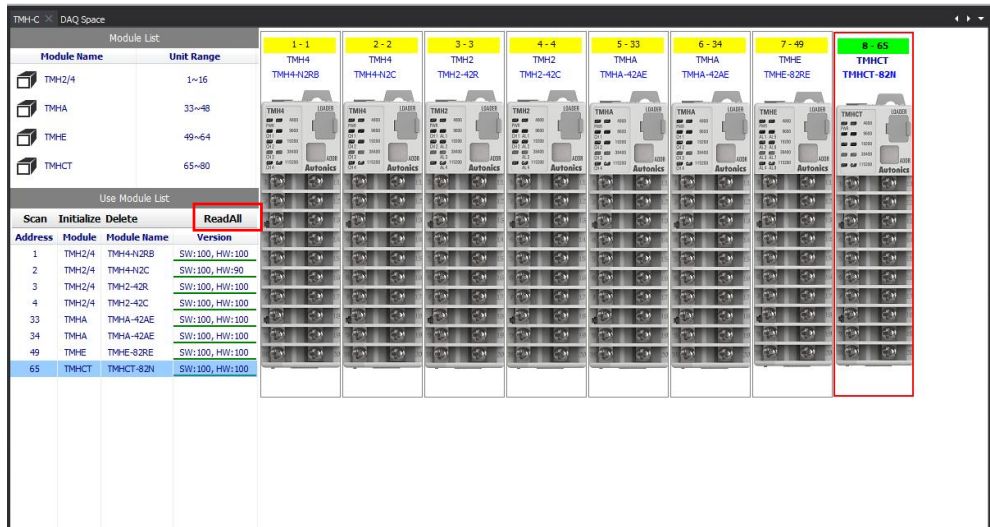

3rd Right-click the module which has the parameters to be copied and click “Copy Parameter” and Copy Parameter dialog box appears.

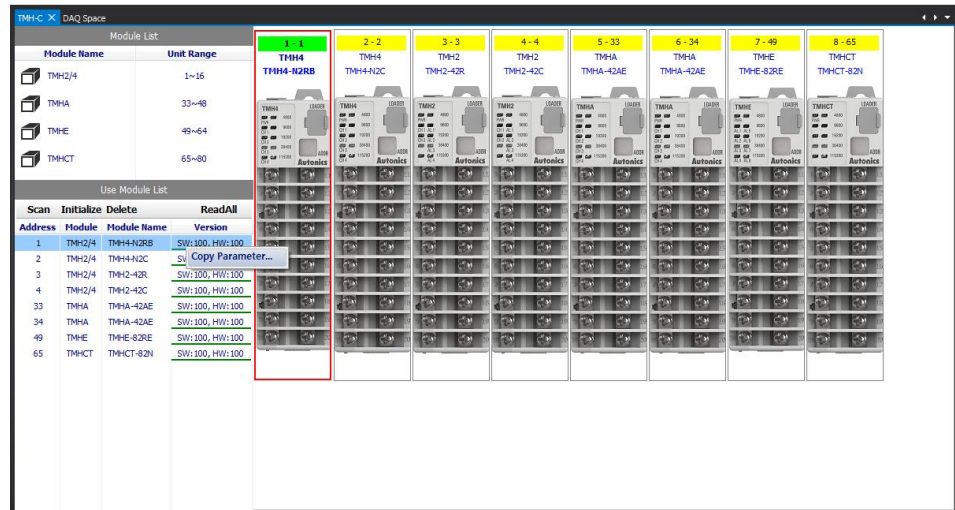

4th Same orders 4th to 5th of the TMH2/4 (control module), TMHA, TMHE, TMHCT (option module) connection.

### 9.4.1 Copy parameters

To connect the several same model units at once, you can copy the parameters. You can copy the saved parameter file or the parameter settings of the dedicated device(standard unit) to the other devices(target units).

#### (1) To copy the saved parameter file,

1st Same orders 1st to 3rd of the Save parameter values.

2nd Check the units to be copied at the check box of the left side of the dialog.

Click 'Open' and select the parameter file and it loads at the right side of the dialog.

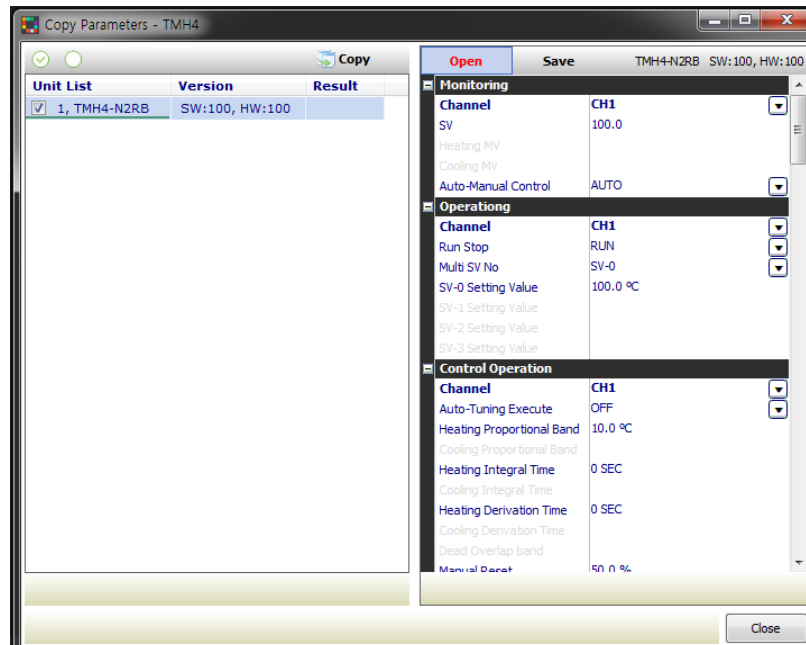

3rd Click 'Copy' and copy is progressing. 'the Process of Copying data' text appears at the right side of the dialog.

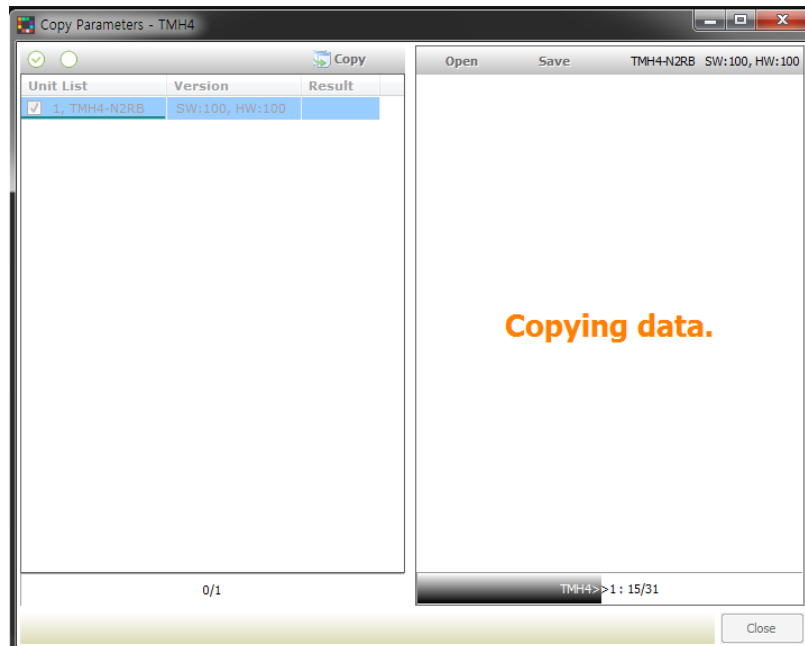

4th After completing copy, 'Copy Complete!' dialog box appears. Click 'OK' and copy is finish.

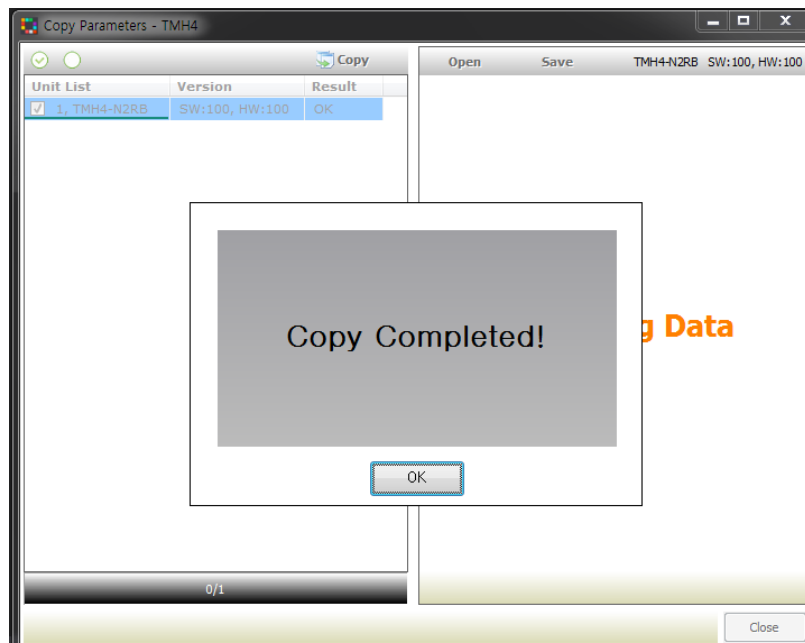

**(2) To copy the parameter settings of the dedicated device(standard unit) to the other devices(target units),**

1st Same orders 1st to 3rd of the Save parameter values.

2nd Check the units to be copying (standard unit) and to be copied (target unit) at the check box of the left side of the dialog.

3rd Right-click the unit to be copying(standard unit) and select 'Parameter Select'. The parameter values of the unit is loaded at the right side of the dialog.

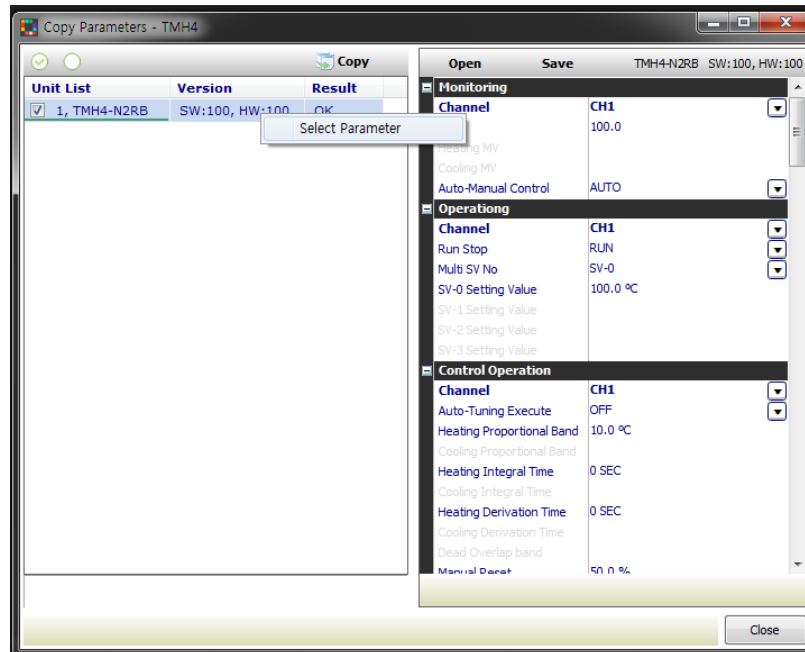

4th Click 'Copy' and copy is progressing. 'the Process of Copying data' text appears at the right side of the dialog.

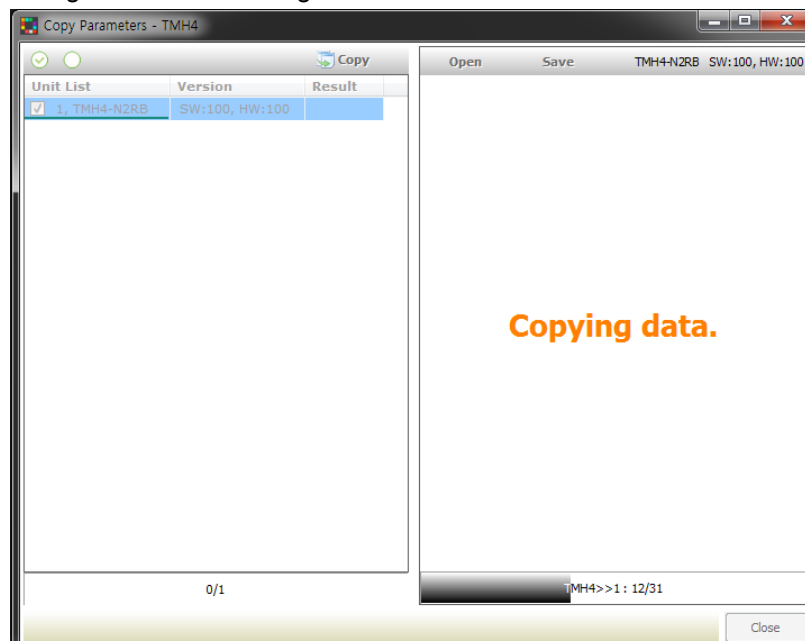

5th After completing copy, 'Copy Complete!' dialog box appears. Click 'OK' and copy is finish.

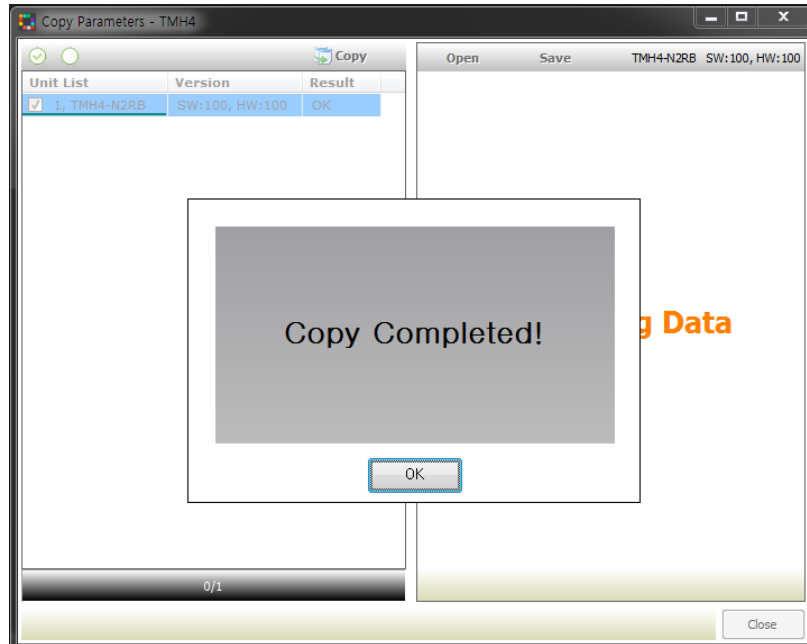



### 9.4.2 User parameter group

This feature is able to set the frequently used parameters to the user parameter group. You can quickly and easily set parameter settings. User parameter group can have up to 30 parameters.

- 1st After reading parameter, run UserGroup parameter at "User Group" of the lowermost Property.

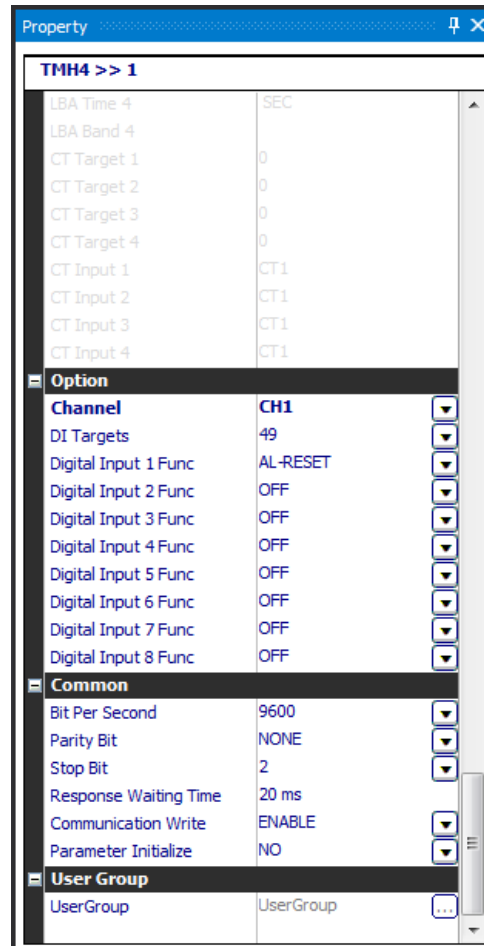

2nd 'Parameter User Group Setting' dialog window appears. Select the parameter to add the user group and double-click it or click the '>' button. Set the user group number (1 to 30) and click 'Ok' button.

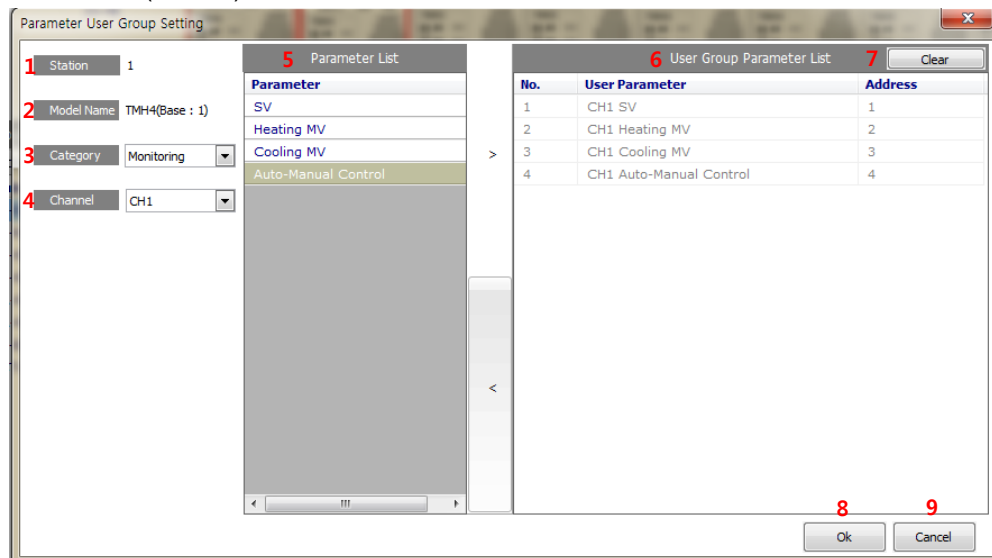

No	Item	Describes
1	Station	Displays device station.
2	Model Name	Displays device model name.
3	Category	Displays parameter category.
4	Channel	In case of channel model, displays channel number. In case of non channel model, displays 'NONE'.
5	Parameter List	Displays device parameters as list. Select Select the parameter to add the user group and double-click it or click the '>' button.
6	User Group Parameter List	Displays the registered parameters for user parameter group as list. No. : Order of device user parameter. User: User parameter name of device. Address: User parameter address of device. Select the parameter to delete the user group and double-click it or click the '<' button.
7	Clear	Delete all the set user parameter group.
8	Ok	Apply the set user parameter group to module.
9	Cancel	Close the dialog window.

# Autonics

## Sensors & Controllers

### Distributor

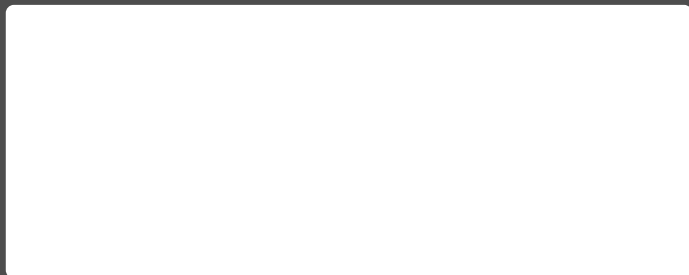

#### Major products

- Photoelectric sensors • Fiber optic sensors • Door sensors • Door side sensors • Area sensors
- Proximity sensors • Pressure sensors • Rotary encoders • Connector/sockets
- Switching mode power supplies • Control switches/Lamps/Buzzers • Temperature controllers
- Temperature/Humidity transducers • SSR/Power controllers • Counters • Timers • Panel meters
- Tachometer/Pulse(Rate) meters • Display units • Sensor controllers
- I/O Terminal Blocks & Cables • Stepper motors/drivers/motion controllers
- Graphic/Logic panels • Field network devices • Laser marking system(Fiber, CO<sub>2</sub>, Nd:YAG)
- Laser welding/soldering system

Any proposal for a product improvement and development: [Product@autonics.com](mailto:Product@autonics.com)

[www.autonics.com](http://www.autonics.com)

#### Headquarters

18, Bansong-ro 513beon-gil, Haeundae-gu, Busan, South Korea

#### Overseas Business Headquarters

#402-404, Bucheon Techno Park, 655, Pyeongcheon-ro, Wonmi-gu, Bucheon, Gyeonggi-do, Korea  
Tel: 82-32-610-2730 / Fax: 82-32-329-0728 / E-mail: [sales@autonics.com](mailto:sales@autonics.com)

#### Brazil Autonics do Brasil Comercial Importadora Exportadora Ltda

Rua Dr. Licio Maraglino, 369 Santo Amaro - Sao Paulo - SP - CEP: 04753-130, Brazil  
Tel: 55-11-2307-8480 / Fax: 55-11-2309-7784 / E-mail: [vendas@autonics.com.br](mailto:vendas@autonics.com.br)

#### China Autonics electronic(Jiaxing) Corporation

#301 YUN HAI ROAD jiaxing, Zhejiang, China, 314001  
Tel: 86-21-5422-5969 / Fax: 86-21-5422-5961 / E-mail: [china@autonics.com](mailto:china@autonics.com)

#### India Autonics Automation India Private Limited

Fantasia Business Park Unit No- G 174 & 175, Plot No.47, Sector 30A,Vashi, Navi Mumbai, India 400 703.  
Tel: 91-22-2781-4305 / Fax: 91-22-2781-4518 / E-mail: [india@autonics.com](mailto:india@autonics.com)

#### Indonesia PT. Autonics Indonesia

JLDewi Sarika No. 171, Jakarta Timur  
Tel: 62-21-5009-9816 / Fax: 62-21-5009-4440 / E-mail: [indonesia@autonics.com](mailto:indonesia@autonics.com)

#### Japan Autonics Japan Corporation

645-1, MIKKAMACHI, MINOWA-MACHI, KAMINA-GUN, NAGANO-KEN 399-4603 JAPAN  
Tel: 81-265-79-8570 / Fax: 81-265-79-2442 / E-mail: [support@autonics.jp](mailto:support@autonics.jp)

#### Malaysia Mal-Autonics Sensor Sdn. Bhd.

Unit No 613 & 614 , Block A, Kalana Business Centre 97, Jalan SS7/2, Kelana Jaya, 47301 Petaling Jaya, Selangor Malaysia.  
Tel: 60-3-7805-7190(Hunting) / Fax: 60-3-7805-7193 / E-mail: [malaysia@autonics.com](mailto:malaysia@autonics.com)

#### Mexico Autonics Mexico S.A. DE C.V

Av. Doctor Gustavo Baz Prada no. 98 Int. 7ºFracc. Industrial Añe Blanco, Naucaipan de Juarez, Estado de Mexico C.P. 53370  
Tel: 52-55-5207-0019 / Fax: 52-55-1663-0712 / E-mail: [informes@autonics.com](mailto:informes@autonics.com)

#### Russia Autonics Corp. Russia Representative Office

Office 2008, entrance "B", section 3, str. Ul'ofa Palme, 1, Moscow, 119590, Russia  
Tel/Fax: 7-495-660-10-88 / E-mail: [russia@autonics.com](mailto:russia@autonics.com)

#### Turkey Autonics Otomasyon Ticaret Ltd. Sti.

Serifali Mh. Turker Cd. Burnan Sk. No.23 Kat.2 Unranıye, Istanbul, Turkey  
Tel: 90-216-365-9117(9113, 9114) / Fax: 90-216-365-9112 / E-mail: [info@autonics.com.tr](mailto:info@autonics.com.tr)

#### USA Autonics USA, Inc.

1353 Armour Blvd, Mundelein, IL 60060, USA  
Tel: 1-847-680-8160 / Fax: 1-847-680-8165 / E-mail: [sales@autonicsusa.net](mailto:sales@autonicsusa.net)

#### Vietnam Cong Ty TNHH Autonics Vina

Nguyen Hung Phu Office Building, No.400 Nguyen Thi Thap Street, Tan Quy Ward, District 7, Ho Chi Minh City, Vietnam  
Tel: 84-8-3771-2662 / Fax: 84-8-3771-2663 / E-mail: [vietnam@autonics.com](mailto:vietnam@autonics.com)